

snom



User Manual

IP Phone D335

TABLE OF CONTENTS

Copyright, Trademarks, GPL, Legal Disclaimers	7
Important information	8
Safety instructions	8
SELV (Safety Extra Low Voltage) compliance	8
Standards conformance	8
Product specifications	9
Disposal of the device	9
Cleaning	9
Setting up the phone	10
Delivery Content	10
Attaching and detaching the footstand	10
Attaching for desktop placement	10
Attaching for wall mounting	11
Detaching	11
Rotating the tab of the cradle	11
Connecting the phone	12
Connecting a headset	13
Initializing and registering the phone	14
Prerequisites	14
Initialization	14
What to do if initialization and registration are unsuccessful	16
Correcting the clock	17
Getting to know your phone	18
At a glance	18
LED indicators	20
Call indicator	20
SmartKey LEDs	20
Page key LED	20
MWI key LED	20
Hard keys	21
Context-sensitive, programmable function keys	21
Navigation, confirmation, and cancel keys	21
Preprogrammed, variably programmable function keys	21
Freely programmable function keys with LEDs	22
Alphanumeric Keypad	23
Input modes and navigation	23
Entering numerals, letters, special characters, and symbols	23

Display layout	25
In idle mode	25
When the phone is active	27
SmartLabels	27
Settings	28
Phone settings	28
Settings available in administrator mode	29
Settings available in user mode	30
Display settings	31
Adjusting the backlight on the phone's display	31
Adjusting display settings for connected D3s	32
The phone's web interface	34
Opening the web interface	35
How the web interface works	36
Web settings overriding manual phone settings	36
User mode/administrator mode	37
Directories	39
Directory	39
Definitions, explanations	39
Directory entries	39
Contact Types	40
Outgoing identity	40
Group	40
Ringtones	40
Adding/Editing Entries on the Phone	41
Adding new entry manually	41
Adding new entry from call list	41
Adding current caller	42
Sorting entries	42
Editing existing entry	42
Deleting an entry	43
Adding/editing entries on the web interface	44
Adding new entry	44
Editing an entry	45
Deleting entry on web interface	47
Dialing from phone directory	47
Deleting whole directory	47
Importing a directory	47
Exporting the directory	48

External directories	48
LDAP	48
Contacts	48
Using the phone	50
Making calls	50
Selecting identity for current outgoing call	50
Using different audio devices	50
Handset	50
Headset	50
Speakerphone	50
Handset <u>or</u> headset and casing speaker	50
Using different dialing methods	51
Auto dial	51
Redialing	51
Calling number from call history (missed, received, dialed calls)	51
Calling number from phone directory	51
Calling number from external directory	51
Speed dialing	52
Calling emergency numbers	52
Call completion	52
QuickLookUp (number guessing / auto completion)	53
Accepting calls	54
Using different audio devices	54
Automatically accepting calls	54
Call pick-up from another extension	54
Call waiting	55
Active calls	57
Hold	57
One call on hold	57
Holding multiple calls	57
Conference	58
Initiating a conference	58
Conference screen navigation	58
Transferring calls	59
Attended transfer	59
Blind transfer	61
Terminating calls	62
Missed Calls	62
Call lists	63
Locking and unlocking the keyboard	64

Rejecting or redirecting incoming calls	65
Manually	65
Automatically	65
Rejecting anonymous calls	66
Call forwarding	66
Settings on the phone and turning on call forwarding	67
Turning off call forwarding	68
Turning forwarding of all calls on/off with a function key	68
Configuring the function keys	69
Function keys on Snom phones	69
Function key page of phone's web interface	71
Programming the function keys	73
Function key settings on the phone	73
Function key settings on the web interface	75
Selected examples for function key programming	76
Example 1, Extension monitoring and call pick-up	77
Example 2, Extension monitoring and call pick-up on D3 expansion module	79
Example 3, Speed dialing	80
Example 4, Changing setting of context-sensitive key	82
Display options for SmartLabel keys	83
Settings on the phone	83
Display mode settings	83
Timer setting for returning display mode to default	85
Timer setting for returning label page to page 1	85
Settings on the web interface	86
Customizing the phone settings	88
Identities/accounts	88
Configuring and editing identity/account	88
Assigning ringtones	90
Date and time formats	91
Date	91
Time	92
Time zone	92
Language settings of phone and web interface	93
Phone language	93
Web interface language	94
Dial tones	94
Emergency numbers	94
Call forwarding	95

Call completion	96
Call waiting	97
Hiding my caller ID	98
Rejecting anonymous calls	99
QuickLookUp (number guessing / auto completion)	99
Speed dial	100
Setting a PIN to unlock the keyboard	101
Software update	102
Manual update	102
Auto provisioning	103
Snom Secure Redirection and Provisioning Service (SRAPS).....	103
Troubleshooting	104
Reboot	104
Hard reboot	104
Reset to factory values	104
TFTP Update	104
Manual initialization	105
Contacting Snom Support	105
Traces	106
Appendix 1 - Display Symbols and Icons	107
Symbols found in the function key line	107
Symbols found in the info bar/status line	109
SmartLabel function symbols	110
Display indications	112
Appendix 2 - Status Messages	114
Appendix 3 - Wall Mounting	115
Appendix 4 - Programmable Functions	117
Freely programmable functions	117
Key Events	121
Appendix 5 - GNU General Public License.....	123

Copyright, Trademarks, GPL, Legal Disclaimers

© 2020 Snom Technology GmbH

All Rights Reserved.

Snom, the names of Snom products, and Snom logos are trademarks owned by Snom Technology GmbH. All other product names and names of enterprises are the property of their respective owners.

Product specifications are subject to change without notice.

Snom Technology GmbH reserves the right to revise and change this document at any time, without being obliged to announce such revisions or changes beforehand or after the fact.

Texts, images, and illustrations and their arrangement in this document are subject to the protection of copyrights and other legal rights worldwide. Their use, reproduction, and transmittal to third parties without express written permission may result in legal proceedings in the criminal courts as well as civil courts.

When this document is made available on Snom's web page, Snom Technology GmbH gives its permission to download and print copies of its content for the intended purpose of using it as a manual. No parts of this document may be altered, modified or used for commercial purposes without the express written consent of Snom Technology GmbH.

Although due care has been taken in the compilation and presentation of the information in this document, the data upon which it is based may have changed in the meantime. Snom therefore disclaims all warranties and liability for the accurateness, completeness, and currentness of the information published, except in the case of intention or gross negligence on the part of Snom or where liability arises due to binding legal provisions.

Our firmware includes some source code that may be used and modified by anyone and everyone under the GNU Public License (GPL) (see "Appendix 5 - GNU General Public License" on page 123), provided they, in turn, make it available to everyone else with the same licensing agreement. Please go to <https://www.snom.com/footer/source-code-gpl-open-source/> for the original GPL license and the source code of components licensed under GPL and used in Snom products.

Important information

Please read the instructions on safety and disposal and on how to set up and use the device before using it and also give them to other users to read or inform those users of their contents. Save this manual and do not give the device to third parties without it.

Safety instructions

Follow the instructions in this manual and other applicable documentation of the device.

- If the phone is not supplied with power via an Ethernet cable, use only a power adapter expressly recommended by Snom Technology. Other power supplies may damage or destroy the phone, affect its behavior, or induce noise.
- Avoid placing the cables where people may trip over them or where they may be exposed to mechanical pressure as this may damage them.
- This device is for indoor use only! NOT FOR OUTDOOR USE!
- Do not install the device in rooms with high humidity (for example, in bathrooms, laundry rooms, or damp basements). Do not immerse the device in water and do not spill or pour liquids of any kind onto or into the device.
- Do not install the device in surroundings at risk for explosions (paint shops, for example). Do not use the device if you smell gas or other potentially explosive fumes.
- Do not use the device during thunderstorms. Lightning striking the power grid may cause electric shocks.
- **Warning:** The handset contains a magnet, and its earpiece may attract small dangerous objects such as needles or pins. Please ensure before each use that no such objects are present.

SELV (Safety Extra Low Voltage) compliance

Safety status of input/output connections comply with SELV requirements.

Warning: To avoid electric shock, do not connect safety extra-low voltage (SELV) circuits to telephone-network voltage (TNV) circuits. LAN ports contain SELV circuits, and PSTN ports contain TNV circuits. Some LAN and PSTN ports both use RJ-45 (8P8C) connectors. Use caution when connecting cables.

Standards conformance



This device complies with the essential health, safety, and environmental requirements of all relevant European directives.

You can download the declaration of conformity at www.snom.com/conformity.

Unauthorized opening, changing, or modifying the device will cause the warranty to lapse and may also result in the loss of CE conformity. In case of malfunction contact authorized service personnel, your seller, or Snom.

Product specifications

- **Safety:** IEC 62368-1
- **CE Mark**
- **Connectors:**
 - 2 x RJ45: 1 x LAN, 1 x PC
 - 2 x 4P4C for handset and optional wired headset (headset not included)
 - 1 x USB 2.0, type A
 - 1 x 6P6C for D3 Expansion Module or EHS Advanced
 - 1 x coaxial power connector DC 5V
- **Ethernet:** 2 x IEEE 802.3/1 Gigabit switch
- **Power:** Power over Ethernet (PoE), IEEE 802.3af, Class 3. If PoE is not available, one of the following power adapters (not included in delivery) can be ordered separately:
 - EU: - Snom A6, Phihong model PSM10R-050, Snom PN 00004325
- Ten Pao, model S018BAM0500200, SnomPN 00004393
 - AU: - Snom A6, Phihong model PSM10R-050, Snom PN 00004325
- Ten Pao, model S018BAM0500200, Snom PN 00004393

Disposal of the device



This device is subject to European Directive 2012/19/EU and may not be disposed of with general household garbage. If you do not know where you may dispose of the device at the end of its lifespan, contact your municipality, your local waste management provider, or your seller.

Cleaning

To clean the device, use an anti-static cloth. Please avoid cleaning liquids as they might damage the surface or internal electronics of the device.

Setting up the phone

Delivery Content

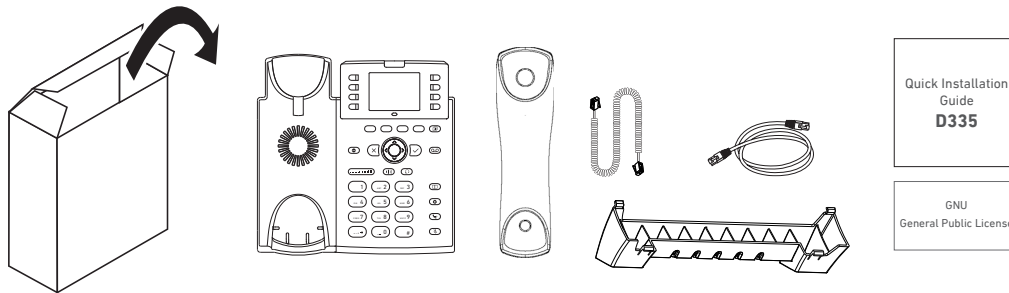

- Base phone unit
- Footstand
- Handset
- Handset cord
- Ethernet cable
- Quick Installation Guide, GNU General Public Licence

Attaching and detaching the footstand

The footstand can be attached in two different positions, depending on whether the phone will be placed on a desk or mounted on a wall. To avoid scratching or otherwise damaging the phone, we recommend turning it upside down and placing it on a soft piece of cloth.

Attaching for desktop placement

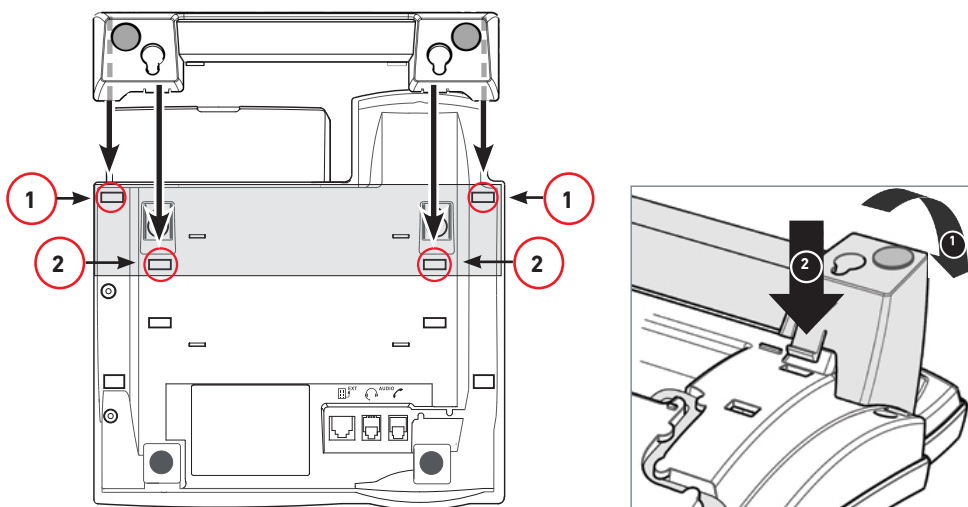

Fig 1

Fig. 2

1. Insert the snap-fits on the longer ends of the footstand into the holes marked ① (Fig. 1 and 2).

2. Tilt the footstand towards you and insert the snap-fits on the shorter ends into the holes marked ② (Fig. 1 and 2).

Attaching for wall mounting

See "Appendix 3 - Wall Mounting" on page 115.

Detaching

Lightly press the snap-fits of the footstand inwards (Fig. 1) and, at the same time, tilt the footstand backwards and lift it from its anchorage in the mounting holes (Fig. 2).

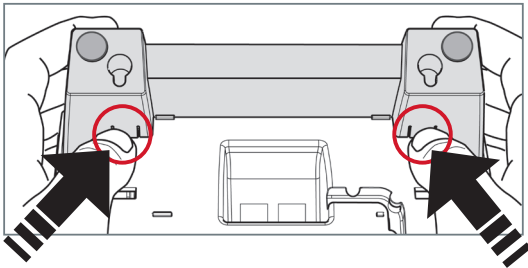

Fig. 1

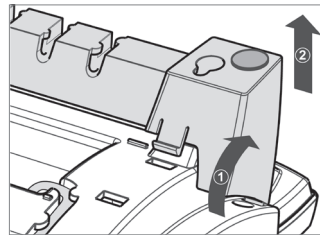

Fig. 2

Rotating the tab of the cradle

The phone is delivered with the tab level with the inner edge of the cradle (Fig. 1). If you are going to mount the phone on a wall, we recommend that you rotate the tab 180°. After rotation, the tip of the tab (Fig. 4) will protrude slightly above the edge of the cradle. The small rectangular hole in the receiver casing fits perfectly over the now protruding tip, holding the receiver safely in place in the upright position on the wall.

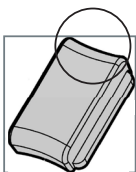

Fig. 1

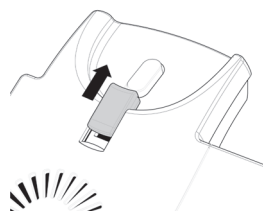

Fig. 2

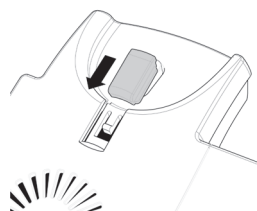

Fig. 3

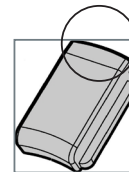

Fig. 4

1. Slide the plastic tab from the cradle (Fig. 2)
2. Rotate the tab 180°.
3. Slide the tab back into the cradle (Fig. 3).

Connecting the phone

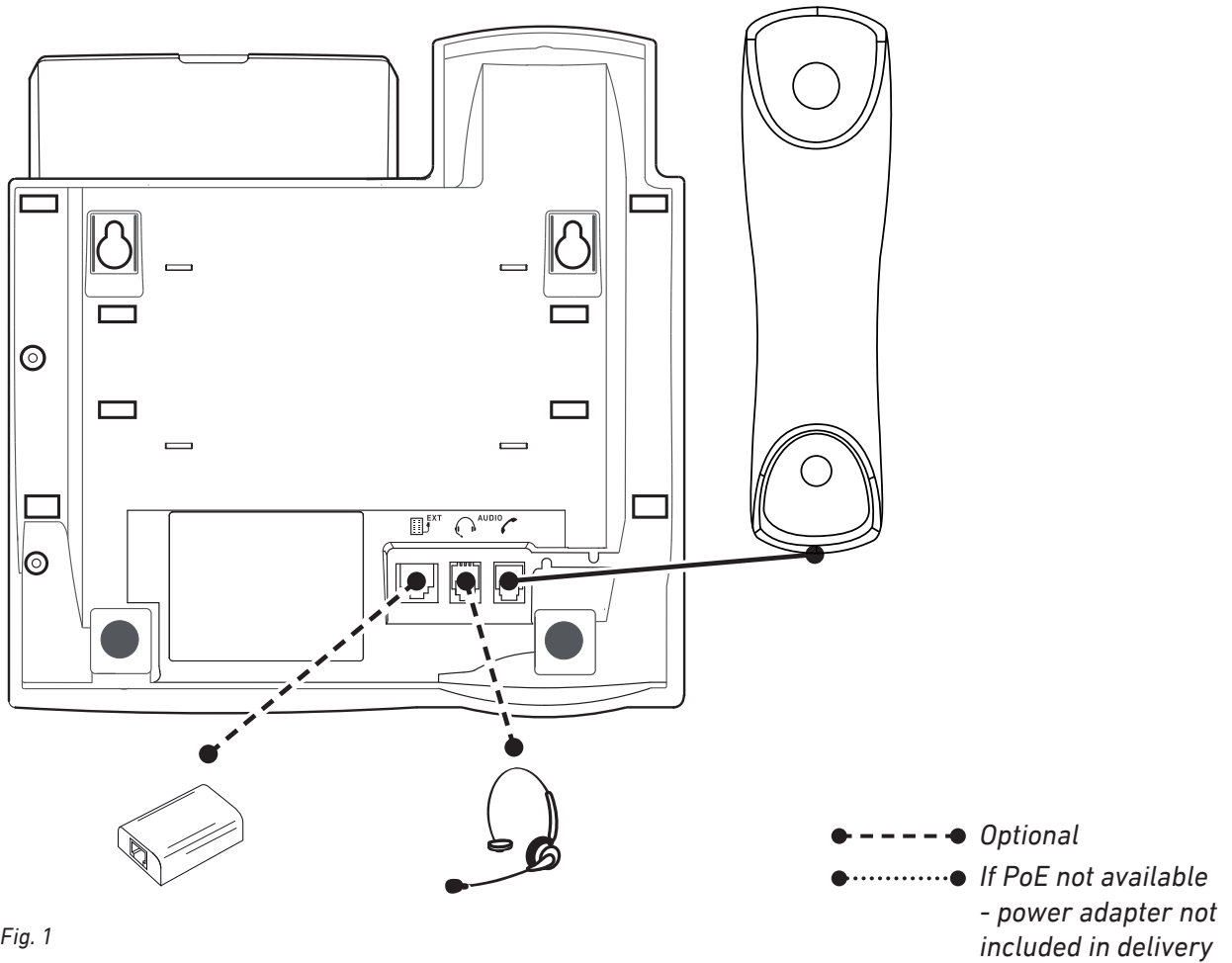

Fig. 1

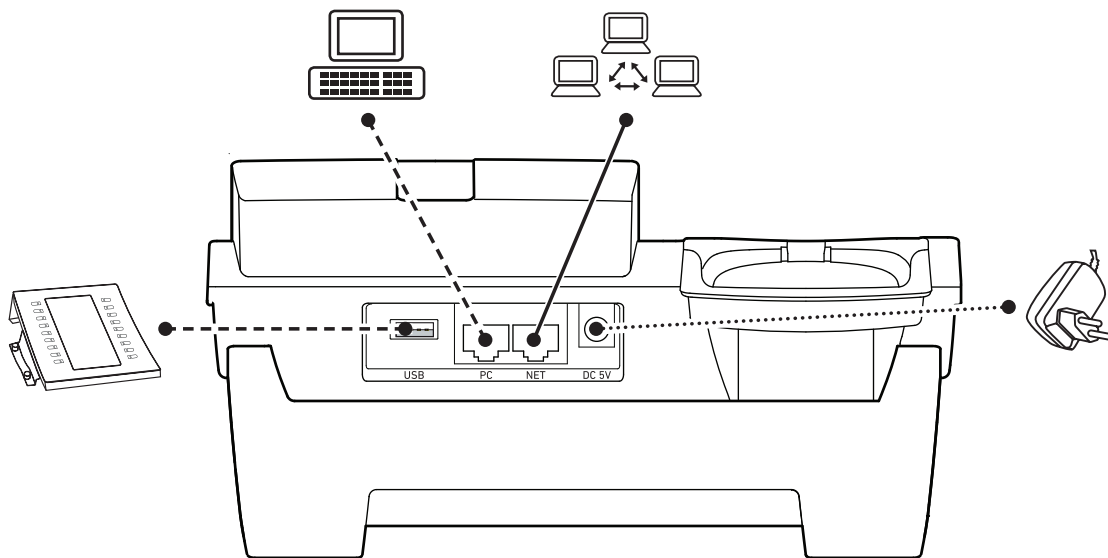



Fig. 2

The phone can be operated with Power over Ethernet (PoE) provided via the network cable or, if PoE is not available in your network, with the separately available 5V DC power adapter (see "Product specifications" on page 9).

1. Plug the long uncurled end of the 4P4C handset cord into the connector labeled  (Fig. 1), and connect the short one to the handset.
2. Plug the Ethernet (network) cable into the RJ45 connector labeled **NET** (Fig. 2) and plug the other end into the network side to establish a data link.
3. If PoE is not available, insert the plug of the power supply into the connector labeled **5V DC** (Fig. 2) and hook up the plug to the wall outlet.
4. The second RJ45 connector, labeled **PC** (Fig. 2), is for daisy-chaining further Ethernet devices without the need for a second Ethernet connection line.

Connecting a headset

You can use wired as well as wireless headsets with the phone.

- Wired headsets

If you want to use a wired headset, connect it to the RJ audio jack labeled  (Fig. 1).

Note: If both a wired and a wireless headset are connected to the phone, incoming calls will go to the wireless headset.

- Wireless headsets



- Connecting the base station of your headset via the Snom EHS Adapter.

- Connect the Snom EHS to the connector labeled  (Fig. 1 on page 12).
- For more information on how to connect the Snom EHS Advanced and the headset, please refer to the **Quick Installation Guide** of the Snom EHS Advanced that came with the device and to the manual of your wireless headset.

- Connecting the headset to the phone via a Bluetooth-compatible adapter.

Insert the adapter into the USB port of the phone. See also the Quick Start Guides of the Snom USB BT and the Snom HS BT or the manual of the third-party headset.

Attention: The default settings for USB headsets are *VID=0a12:PID=100d:HOOK=38/1* for 8.7.2.11 and higher.

- If your phone is running an earlier firmware version, enter these parameters manually on the phone's web interface at > **Advanced** > **Audio** > text field of "Audio parameters". Click the question mark  to look up the parameters.
- If you are using a different headset, whatever the firmware version, enter the parameters of the headset manually on the phone's web interface at > **Advanced** > **Audio** > text field of "Audio parameters". Click the question mark  to find out which parameters you need to use for your respective headset.

Initializing and registering the phone

Prerequisites

To be able to use VoIP, you or your company must have:

- A broadband internet connection.
- Access to the internet via a router. This could be a separate device available in various versions from many different manufacturers or in the form of a router on a server or a PC.
- Account information provided by your network administrator or a VoIP account with a VoIP service provider who supports the VoIP SIP standard. The phone supports up to 12 VoIP accounts with one or more VoIP providers.

The registration information received from your Internet service provider or your network administrator may differ and may contain required and optional data. The required data normally includes:





- Account (usually the phone number). On Snom phones, an account is called an "identity".
- Registrar
- Password



User name, authentication name, and outbound proxy may also be required. These are settings that can only be configured on the web interface of the phone after it has been successfully registered. If your provider or your network provides a mailbox account, that setting is also configured on the web interface. For more information, see "Identities/accounts" on page 88.

Initialization

Snom phones are plug-and-play. Once the phone is connected to your network, it will begin to initialize.

Note: Normally the initialization is completely automatic, using DHCP. If the phone cannot discover a DHCP server in the subnet, you will be asked: Are you using DHCP? If your network does not support DHCP, press  and enter the IP address, netmask, IP gateway, and DNS server manually. Ask your Internet service provider or your network administrator for them.

Watch the display and, when asked to, make selections with  /  on the navigation key  and save with .

1. You will be prompted in English to select a language (Fig. 1). Use  /  to select another language, if applicable, and press  to save the highlighted language.
2. Next, you will be prompted in the language of your choice to select a time zone (Fig. 2). This affects the time shown on your display.

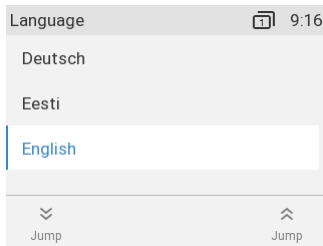

Fig. 1

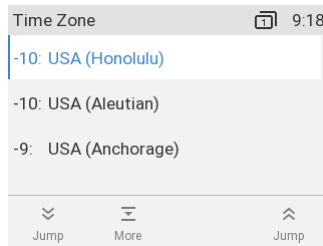

Fig. 2

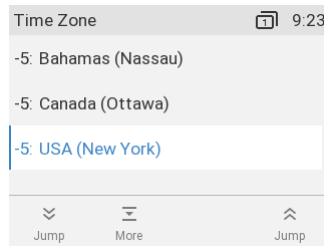
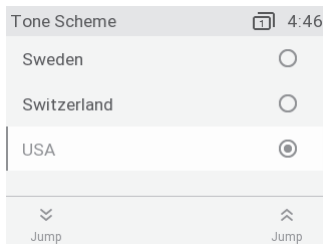
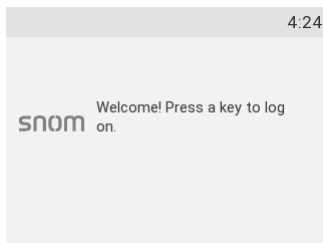

Fig. 3

- Press **▲** or **▼**, respectively, on the navigation key to move up or down the list one item at a time; press the function key underneath **⇩** or **⇧**, respectively, to jump to the beginning of the next or the previous time zone.
 - Press the function key underneath **≡** to show only those time zones where the selected phone language is spoken. If you have selected English, all time zones are shown (Fig. 2).
 - Press the function key underneath **☰** to show all time zones and all countries or cities within the individual time zones, if there are any.
 - Press **☑** to save the selected time zone, indicated by the white bar (Fig. 3).
3. Next, you will be prompted to select the tone scheme of a country. This affects the dial tone you hear when you pick up the receiver. Different countries use different dial tones.



- Press **▲** or **▼** to move up or down the list one item at a time.
 - Press **⇩** to jump to the bottom country on the screen; when the last country is selected, pressing **⇩** results in jumping to the last country on the next screen.
 - Press **⇧** to jump to the first country on the screen; when the first country is selected, press **⇧** to jump to the first country on the preceding screen.
 - Press **☑** to save the selected country's tone scheme.
4. The display shows the "Welcome" screen. Press any key to log on.



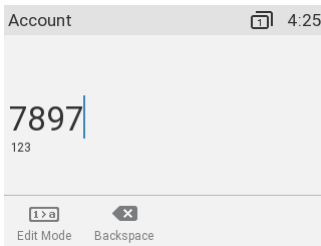

5. Enter the account number and save with **☑**.



Note: See "Entering numerals, letters, special characters, and symbols" on page 23 on how to enter numbers and letters.

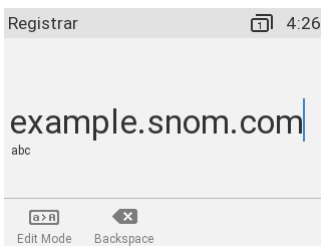

6. Enter the registrar and save with .

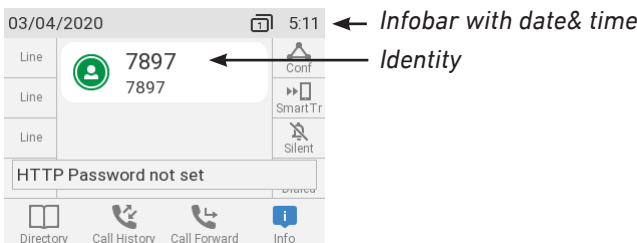

7. If required, enter the password received from your Internet service provider or administrator and press .

After successful registration you will see the identity symbol  and the registered account (identity) in the identity line underneath the date/time bar:



Note: If you see the account on the display preceded by  or  and the phone is not working, the server may be down, either for servicing or due to a malfunction. The registration and initialization should be completed as soon as the server is up and running again. You may want to check with your administrator or your provider if nothing happens within a reasonable amount of time.

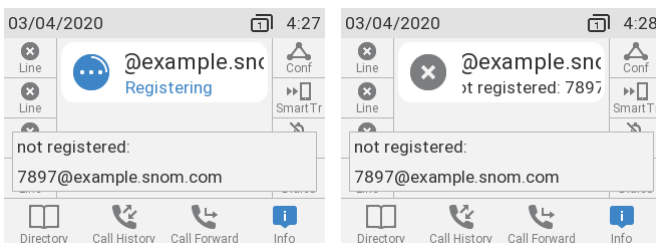

What to do if initialization and registration are unsuccessful

Your network or your VoIP provider may require more login data than requested by the Snom phone during the initialization and registration process. This data is entered on the web interface of the phone. Contact your network system administrator or your VoIP provider for more information.

1. When you have received all necessary data, open the phone's web interface. See "Opening the web interface" on page 35 for more information.
2. Open Configuration Identity 1 and enter any additional login information you have received from your provider. See "Identities/accounts" on page 88 for more information.

Note: A number of IP telephony service providers and a number of SIP PBXs require settings that are different from Snom's standard factory settings. Snom's web page lists numerous providers and PBXs that have been tested for interoperability with our phones and specific settings that may be required. Do not change the standard configuration unless you know what you are doing. Expert help may be required.

Correcting the clock

The phone receives the time and date from your NTP time server. If the time and/or date on the display are incorrect, you may need to set the correct time zone. This setting is available in admin mode only.

- Changing the settings on the phone and on the web interface: See "Time zone" on page 92.

If the time is still incorrect, there may be a problem with the time server. Contact your network administrator or your IP provider.

Default formats:

- **Time.** 24-hour clock, e.g. 17:35. Changing to AM and PM formats: See "Time" on page 92.
- **Date.** US date format MM/DD/YEAR, eg. 11/23/2010. Changing to European format DD.MM.YEAR, e.g. 23.11.2010: See "Date" on page 91.

Getting to know your phone

At a glance

The factory settings at a glance:

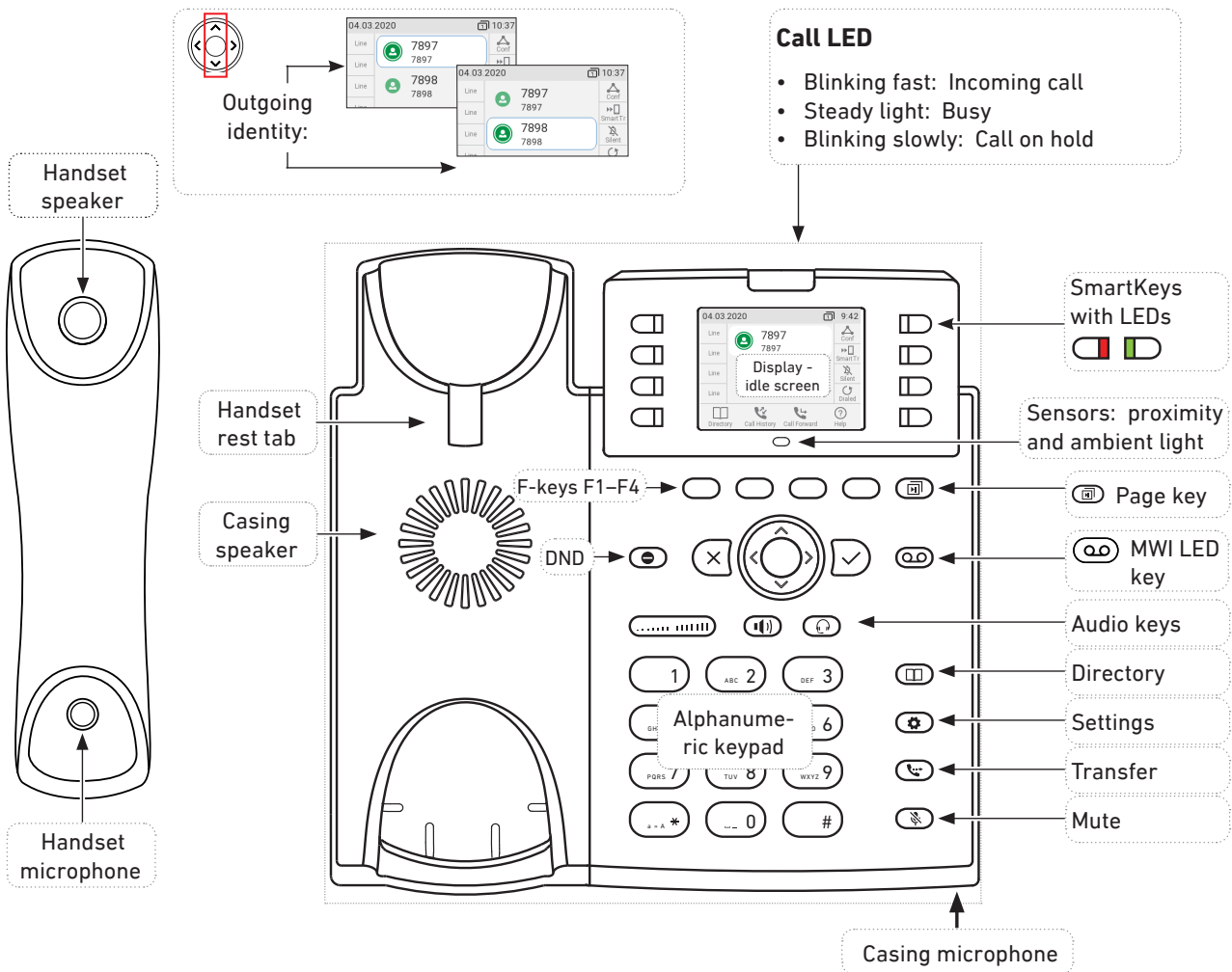

Context-sensitive, programmable function symbols and function keys F1-F4

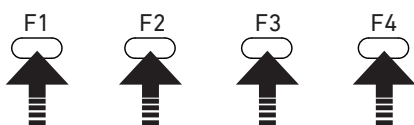
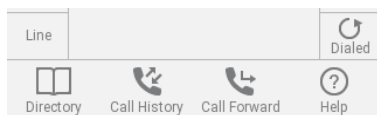





Press the function key underneath the display symbol to activate the function, open the list etc. depicted by the symbol above the key.







Standard functions available on idle screen. Default settings and icons depend on firmware installed on phone.

- Internal phone directory
- Call lists (missed, received, dialled calls)
- Forwarding all calls (turning CFwd on/off)
- Status information (call forwarding active, passwords not set, missed calls, etc.) or, if no status info, to show phone's IP address and URL to Snom's Wiki

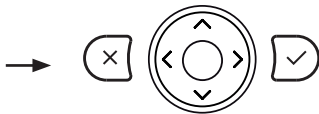



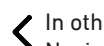

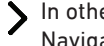
Audio control keys

-  Adjusting the volume
 - of the ringer when the phone is idle or ringing
 - of the handset/casing loudspeaker when in a call
-  Toggling between handsfree and handset mode. Press to dial number and accept calls on speakerphone.
-  Headset mode on/off
-  Mute/unmute microphone

Navigation keys

- Canceling actions & input, and returning to previous screen
 - Terminating calls on speakerphone and in headset & handset modes
 - Confirming, saving actions & input, and returning to previous screen
 - Accepting calls on speakerphone and in headset mode
 - **From idle screen: Dialed calls (redial)**
- 
-
-  From idle screen: Select outgoing identity
 -  In other contexts (settings, lists): Navigate up/down
 -  From idle screen: Missed calls
 -  In other contexts: Navigate/space left
 -  From idle screen: Received calls
 -  In other contexts: Navigate/space right

Dedicated, customizable function keys

-  Page key for SmartKey screens: Press key to put the next page of 4 pages on screen.
-  MWI key with LED
 - LED is lit when message is waiting on mailbox (if mailbox supplied on PBX)
 - Press key to listen to message(s)
-  Turn DND (do not disturb) on and off. Callers hear the busy signal.
-  Directory
-  Settings menu
-  Transfer

Freely programmable SmartKeys with LEDs, P1 - P32 

Default setting: Line

- Fast-blinking LED: Incoming call. Press key or  to accept
- Steadily lit LED: In call
- Slow-blinking LED: Call on hold

- Page 1: P1–P8
- Page 2: P9–P16
- Page 3: P17–P24
- Page 4: P25–P32

Star key 

- In editing mode:
 - Press for one second to change input mode (numerals > lower case > upper case)
 - Press briefly to type *
- On idle screen: Press for 3 seconds to **lock/unlock the keypad**

Pound (hash) key 

- In editing mode: Press briefly to type #

LED indicators

Call indicator

The bright-red LED situated at the top of the display indicates incoming, ongoing, held, and missed calls. It will be:

- Blinking rapidly when a call is coming in
- Glowing steadily when dialing, when in a call, and when you have missed a call. To turn the LED off after a missed call, press the left arrow  on the navigation key to open the **Missed calls** menu and simultaneously turn off the LED.
- Blinking slowly when you have put a call on hold

SmartKey LEDs

Depending on the function mapped onto the key, the red or green LEDs on the key will be activated when the key event occurs. The factory setting is red LED and "line". The LEDs of a line key will:

- blink rapidly when a call is ringing on the line;
- glow steadily when there is an ongoing call on the line;
- blink slowly when a call is on hold on the line;
- be off when the line is free.

When other functions are mapped onto the keys, the LEDs may glow or blink. For example: When the "extension" function has been mapped onto a key and monitoring of extensions is enabled on both phones, the LED will

- blink rapidly when a call is ringing on the extension;
- glow steadily when the extension is busy;
- be off when the extension is not busy.

Page key LED

The LED glows red. The function is programmable.

MWI key LED

The LED glows red when there is a new message on the mailbox.

Hard keys

Context-sensitive, programmable function keys

These function keys can be programmed on the **Function Keys** page of the phone's web interface with a number of key events; these functions will then be available when the phone is in idle mode. For more information, see "Configuring the function keys" on page 69. For the factory default settings, see "At a glance" on page 18.

You cannot change the functions that are available when the phone is active, e.g., when you are in a call, when the phone is ringing, etc. Depending on the activity, different functions will be available.

Navigation, confirmation, and cancel keys

can be programmed with the key events available in their drop-down menus. See "Configuring the function keys" on page 69 for further information. Factory settings:

Navigation key	
	<ul style="list-style-type: none"> On idle screen: Press to select identity for outgoing calls In other contexts: Moving up and down lists one item/button at a time
	<ul style="list-style-type: none"> In text fields, press to move the cursor to the left one character at a time. On idle screen, press to open list of missed calls.
	<ul style="list-style-type: none"> In text fields, press to move the cursor to the right one character at a time. On idle screen, press to open the list of received calls
	<ul style="list-style-type: none"> Press to accept calls on speakerphone and in headset mode. Press to confirm actions/settings and return to preceding screen. On idle screen: Redial.
	<ul style="list-style-type: none"> Press to terminate calls on speakerphone and in headset and handset modes. Press to cancel actions and return to preceding screen.

Preprogrammed, variably programmable function keys

The factory setting is printed on the respective key. Other functionalities can be programmed onto them. See "Configuring the function keys" on page 69 for more information.

	Page key for SmartKeys. Press the key to put the next "page" of four label "pages" on screen.
	Message key. The LED on the key is lit when a new message is waiting on the mailbox. Press the key to retrieve messages.
	<p>In "do not disturb" (DND) mode incoming calls do not ring; callers hear the busy signal. If there is an active setting for call forwarding on busy, incoming calls will be forwarded to the number specified in the setting (see "Call forwarding" on page 66). Exception: Calls from phone numbers on your directory's VIP list (see "Contact Types" on page 40) will ring on your phone.</p> <p>Press the key to turn the function on and off for all identities registered on the phone (Fig. 1). If you want to turn on DND for one or more, but not all of the identities (Fig. 2 and 3), use the identity settings on the phone's web user interface.</p>

Settings: On the phone's web interface, select the identity. Click the **Features** tab, then the **on** radio button for **DND**, and **Apply**.

When DND is on, you'll see the DND symbol in front of the respective identity; if the identity is the outgoing identity, the symbol also appears in the info bar (Fig. 1 and 3).

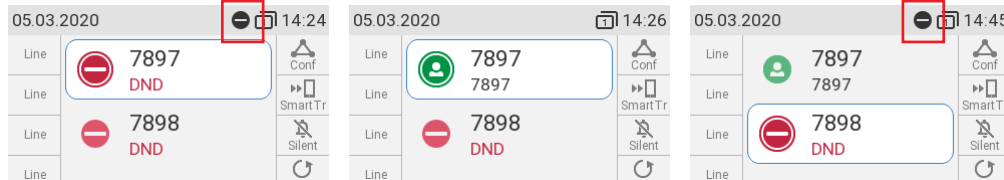









Fig.1 - DND active

Fig. 2 - DND active for a configured identity

Fig. 3 - DND active for current outgoing identity

	Phone directory. See "Directories" on page 39 for further information.
	Settings menu. See "Settings" on page 28 for further information.
	Transfer. See "Transferring calls" on page 59 for further information.

Audio Control Keys

	Press the right or left edge of the key to adjust the volume of the ringer when <ul style="list-style-type: none"> the phone is idle or ringing, of microphone/loudspeaker when in call
	<ul style="list-style-type: none"> Toggling between handsfree and handset mode Dialing numbers on speakerphone Accepting calls on speakersphone
	Toggling between headset and handset modes. Please note: Handset mode overrides headset mode. When the handset is picked up, the headset symbol in the status line will be replaced by the handset symbol, indicating that you can now use only the handset for the call. The phone will return to headset mode when the handset is placed in the cradle, and the headset symbol will reappear in the status line.
	Muting and unmuting the microphone when in a call. When the microphone is muted, the mute symbol is displayed in the info bar. 

Freely programmable function keys with LEDs

These 4 x 8 = 32 freely programmable function keys can be programmed and labeled on the phone and on the **Function Keys** page of the phone's web interface. For information on how to map functions onto these keys, see "Configuring the function keys" on page 69. The factory default setting is line, except for keys P5–P8 which are preprogrammed with the following functions:

P5	Conference	See "Conference" on page 58 for more information.
P6	Smart transfer	Provides a target (extension or phone number) for blind transfer of the current connected call and for a ringing call when there is no current connected or held call. On idle, pressing the key will speed dial the target number.
P7	Silent mode	Turns off the phone's ringer; red LED lights up. Press again to turn it back on; LED turns off.
P8	Dialed	List of dialed calls for redialing, last-dialed call at the top of the list.

Alphanumeric Keypad

Input modes and navigation

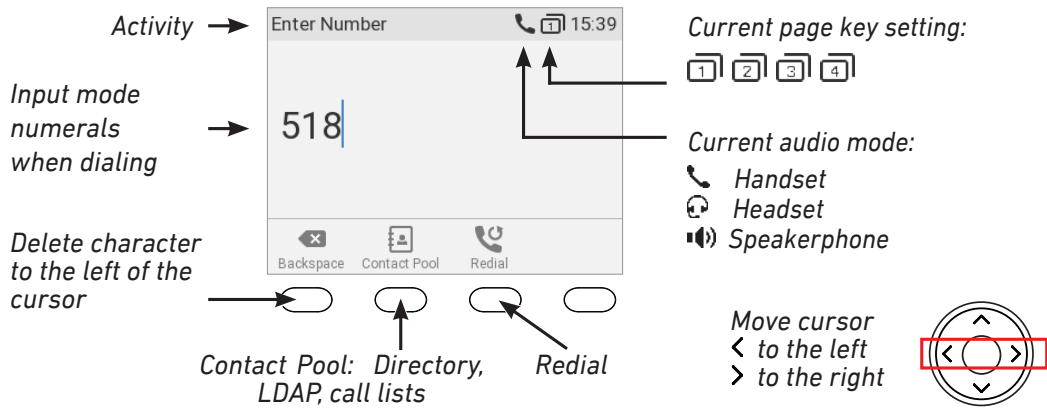

Fig. 1

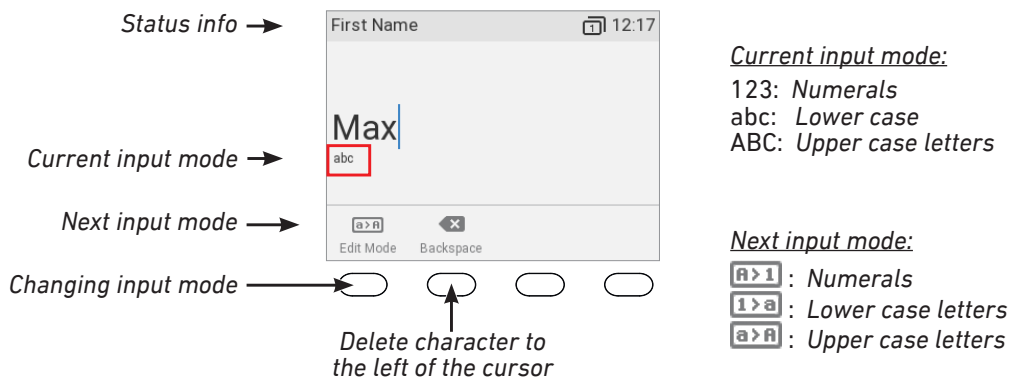

Fig. 2

Press any key on the alphanumeric keypad or pick up the handset to open the "Enter Number" screen. When dialing a number (Fig. 1), the input mode is always numerals. When editing directory entries (Fig. 2) and identities, the current input mode is indicated in the line underneath the cursor. Press the left function key underneath the display to switch to the next input mode.

Text underneath cursor = current input mode	Press function key to switch to next input mode	Next input mode
123	1>a	abc
abc	a>A	ABC
ABC	A>1	123

Entering numerals, letters, special characters, and symbols

When entering letters and special characters, pause briefly after each character until the cursor has moved forward so that you won't overwrite the last character you entered. Pausing is not necessary when entering numerals.

Numerals. In numeral mode, press the respective number key to type the number printed on the key.

Letters. When in input modes lower and upper case letters, press the alphanumeric key with the respective letter one, two, three, or four times quickly to type the first, second, third, or fourth letter printed on the key. Pause briefly after each letter.

Example: In lower case letter mode, press the "2" key once to type an "a", twice to type a "b", and three times to type a "c".

Letters with accents and umlauts. When in input modes lower and upper case letters, press the alphanumeric key with the basic form of the respective letter as many times as necessary. Pause briefly after each letter. Available letters with accents and umlauts depend on the phone's language setting.

Example: If the phone language is German, press key "2" four times to type "ä".

Entering special characters and symbols. In input modes lower and upper case letters, press keys "0" and "1" one or more times quickly. Pause briefly after each character or symbol.

- Period. Press "1" once.
- Space (" "). Press "0" once.
- Underscore ("_"). Press "0" twice.
- Special characters listed in the following table. Press "1" as many times as indicated:

1x	.	2x	+	3x	@	4x	1	5x	:	6x	,		
7x	?	8x	!	9x	-	10x	_	11x	/	12x	\	13x	(
14x)	15x	;	16x	&	17x	%	18x	*	19x	#		
20x	<	21x	=	22x	>	23x	\$	24x	[25x]		

Display layout

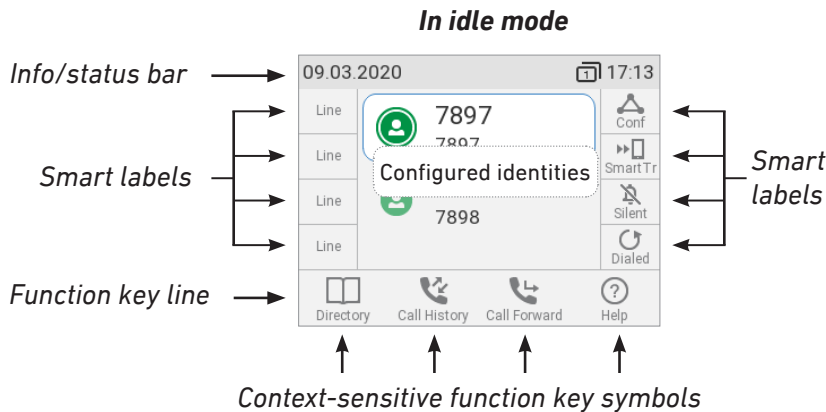

Fig. 1

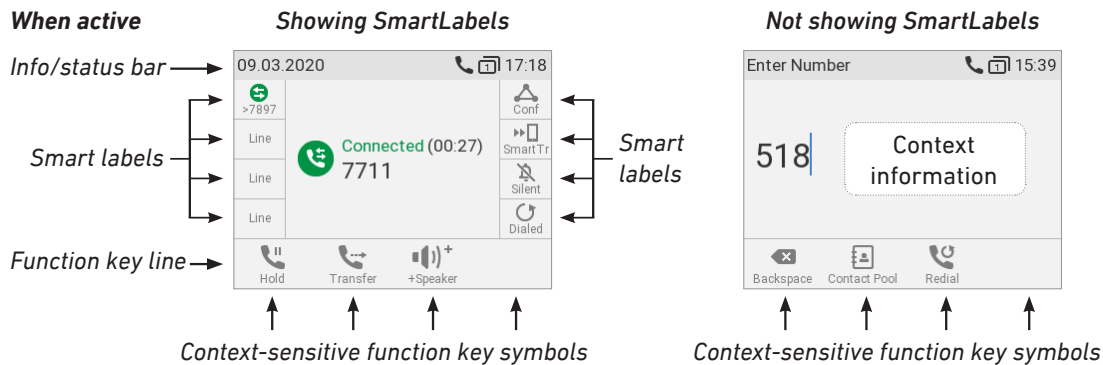

Fig. 2







In idle mode

In idle mode, the display presents the following information:







Info bar/status line

- When there are no status messages or if they have been deleted until the next reboot: Date and time.
- When there are status messages: Any of numerous messages concerning the current status of the phone might be displayed in this bar, for example the availability of a firmware update, a reboot being required, etc. If there is more than one current status message at any one time, the one with the highest priority will be shown. Some of the status messages you may see in idle mode are:
 - The text "Missed:" and the total number of missed calls since the last time you turned off the missed call indication (the text in the info bar as well as the call LED). The missed calls will remain in your missed call list, however.
 - The texts "Forward All:", "Forward when busy:", or "Forward after timeout:" and the phone number calls will be forwarded to.
 - The warnings "HTTP Password not set" and "Admin Password not set". They can be turned off by setting the passwords.

Deleting or temporarily suppressing status messages:

- Messages will be deleted automatically when the underlying cause is removed, i.e., call forwarding is turned off, HTTP password is set, etc.
- Temporarily suppressing messages: Press , if the button is available, or  > **Information** > **Status info** to open the "Status info" screen. Use   to select an item from the list. Press  to view details of the selected item, if available; press  to delete the selected item.
- Messages classified as important cannot be deleted. Examples: "HTTP Password not set", "Admin Password not set".

Context area: Configured identities.

 	<p>Outgoing identity</p> <p>The current outgoing identity is indicated by a green ring around a green circle on a white bar with a thin blue line on the left side. When you call someone, this is your identity for the call.</p> <p>Active identity</p> <ul style="list-style-type: none"> • An active identity that is not the current outgoing identity is indicated by a green circle. • It can be called. • It can be selected as the outgoing identity for making calls by pressing  /  on the navigation key.
	<p>A blue circle with a revolving white ring indicates that the identity is trying to register.</p>
	<p>A gray circle with a white "x" indicates that the identity is not properly registered. Check your connections and whether the server is down.</p>

Note: Identities can be deactivated without removing the registration settings by changing their status to "inactive" on the phone's web interface. Inactive identities are not displayed on the idle screen. They cannot be called or selected as the outgoing identity. To deactivate the identity, open the phone's web interface and select the **Configuration Identity** (1-12).

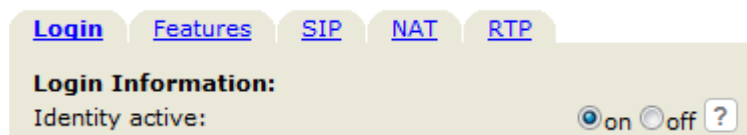









1. Change the "Identity active" setting to **off**.
2. Click **Re-Register**.
3. Click **Save**.

For information on configuring new identities or modifying existing ones, see "Identities/accounts" on page 88. The default setting for the freely programmable function keys controlling the information shown on the SmartLabels is "line", except for keys P5–P8. For more information on the labels, see "Freely programmable function keys with LEDs" on page 22; for information on mapping other functions onto the keys, see "Configuring the function keys" on page 69.

Function key line

The symbols on the buttons in this line depict the functions that can be activated by pressing the function key underneath the respective symbol. See "Appendix 1 - Display Symbols and Icons" on page 107 for a complete list. The factory defaults are:

	Directory. See "Directory" on page 39.	
	Call history. See "Call lists" on page 63.	
		Forwarding all calls (on/off). See "Call forwarding" on page 66 and 95.
	Pressing this key will put the IP address of the phone on-screen. If another function is mapped onto the key or if the key has been replaced by  because of new status messages, IP address and URL can also be looked up in the settings menu:  > Information > Help.	
	<p>Displaying all currently available status messages. This key is available whenever a status message becomes newly available even when a different function is mapped onto the far-right function key underneath the display.</p> <p>Press the key to display the status messages; press  to delete the highlighted status message. When all messages have been deleted, the symbol will disappear from the function key line; the message in the status line will also disappear.</p> <p>The function mapped onto the key is now available on this key again. If you have mapped the "Status messages" function onto the key, the key will remain blank until a new status message becomes available or until a reboot when all current status messages will be displayed anew.</p>	

When the phone is active

The display will inform you of any activity the phone is engaged in (see Fig. 2 on page 25). This information is presented in the form of text or symbols or both.

Info/status bar. Name of current activity and time.

Context area

Depending on the activity, this area will contain symbols (incoming call ringing, outgoing call ringing, list entries, etc.) and text like the phone number calling, the extension number being called, conference partners, etc.. Depending on setting and context the SmartLabels will or will not be visible.

Function key line

Depending on the current activity of the phone, the function key line will present various functions that can be activated by pressing the function key underneath the respective symbol. See "Appendix 1 - Display Symbols and Icons" on page 107 for a list of available functions.

SmartLabels

When the phone is idle and—in some contexts when it is active—the labels of the freely programmable function keys are displayed on four (4) "pages" in eight (8) label areas each, four on

each side of the display (Fig. 1). By moving your hand across the motion sensor underneath the display you can increase the size of the SmartLabels from the default "short" display mode (Fig. 2) to "full" (Fig. 3); the display will revert to "short" display mode after three seconds.

The page number to the left of the time indicates which label page is on-screen, [1], [2], [3], or [4]. Press [4] to change the page from 1 to 2, 3, and 4 and back to 1 (Fig. 4). The default is [1]; the display will return to the default after 10 seconds.

The settings can be adjusted on the phone and on its web interface. See "Configuring the function keys" on page 69 for more information.

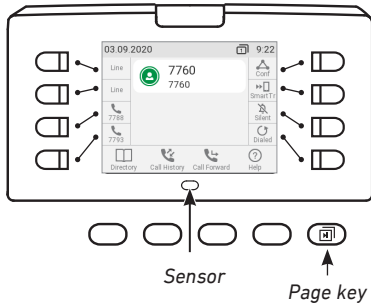

Fig. 1

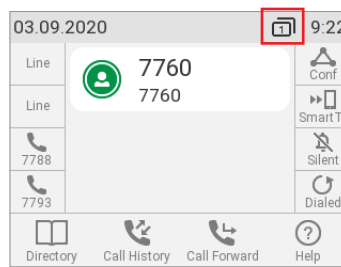

Fig. 2

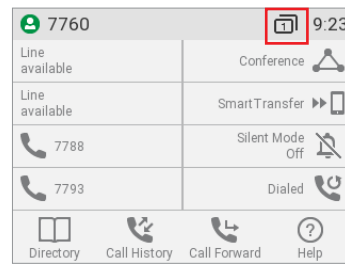

Fig. 3

The LED of the key [4] associated with the label of the on-screen page will react in accordance with the visible label's mapping; pressing the key may affect its visible setting.

The function keys can be mapped on the phone and, faster and more comfortably, on the phone's web interface. For information on programming the function keys, see "Configuring the function keys" on page 69.

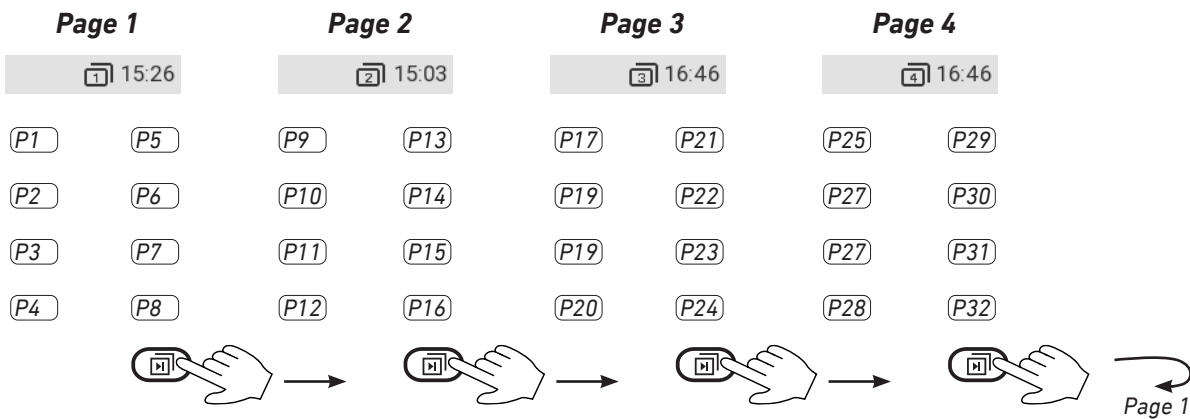

Fig. 4

Settings

A comparatively small number of settings can be adjusted on the phone; many more are available on the phone's web interface.

Phone settings

Press [Settings] to open the settings menu on the display. To open submenus and settings, press their number on the alphanumeric keypad or scroll to the setting and press [Enter].

Settings available in administrator mode

All settings of the phone menu and on the phone's web interface are accessible.

1 Preferences	2 Call Features	3 Identity	4 Network	5 Maintenance	6 Information
1 Language	1 Call forwarding	1 Select outgoing identity	1 IP Settings	1 Security	1 Status info
2 Date & Time	1 Forward all	2 Reregister identity	1 IPv4	1 Admin mode on ⁽²⁾	2 System info
1 Time zone	2 Forward when busy	3 Edit identity	2 IPv6	2 Set keyboard lock PIN	3 Demo mode
2 Date format	3 Fwd after timeout	1 Hotdesking	2 Webserver	2 Reboot	4 Help
3 24-hour clock	2 Outgoing calls	2 Edit identity	1 On/off	3 Reset values	
3 Audio	1 Auto dial	4 Logoff identity	2 Webserver type	4 Synchronize settings	
1 Headset detection	2 Auto redial on busy	1 Log off all identities	3 User name		
2 Tone Scheme	3 Call completion	2-13 (select individ. identity)	4 Password		
3 Ringer	4 Hide own outgoing ID		3 VLAN		
4 Volume	3 Incoming calls		1 VLAN ID (1-4094)		
4 Display	1 Call waiting		2 VLAN Priority (0-7)		
1 Display ⁽¹⁾	2 Auto answer		4 WLAN		
1 Ambient light sensor	3 Reject anonymous		1 On/off		
2 Backlight on activity	4 Silent mode		5 Advanced		
3 Backlight when idle	5 DND		1 802.1X		
4 SmartLabel options	4 Speed dial		2 Hardware		
Idle screen			3 NTP		
Call screens	5 Fkeys		4 DNS		
Other screens	1 Context-sensitive keys				
Return to default mode (timer)	2 Dedicated keys				
Return to page 1 (timer)	3 SmartLabel keys				
2 Expansion modules ⁽¹⁾	Page 1-4				
1 Backlight on activity	4 Expansion mod. keys ⁽¹⁾				
2 Backlight when idle	6 General				
3 Contrast	1 Quick dial contacts				
4 Appearance	2-4 Quick Lookup				

⁽¹⁾ Only if phone model supports expansion modules and when an expansion module is connected.

⁽²⁾ Pressing this key will put the phone in user mode; many settings will not be accessible (see next page). The administrator password will be needed to return the phone to admin mode.

NOTE: The factory default administrator password is 0000 (4 x zero). For security reasons, we recommend that you set your own administrator password. **Be sure to write it down and store it in a safe place** because if it is lost or forgotten, you will not be able to return the phone from user to administrator mode and gain access to all phone settings.

Settings available in user mode

1 Preferences	2 Call Features	3 Identity	4 Maintenance	5 Information
1 Language	1 Call forwarding	1 Select outgoing identity	1 Security	1 Status info
2 Date & Time	1 Forward all	2 Reregister identity	1 Administrator mode off ⁽²⁾	2 System info
1 Date format	2 Forward when busy		2 Set keyboard lock PIN	3 Help
2 24-hour clock	3 Forward after timeout		2 Reboot	
3 Audio	2 Outgoing calls		3 Synchronize settings	
1 Headset detection	1 Auto redial on busy			
2 Tone Scheme	2 Call completion			
3 Ringer	3 Hide own outgoing ID			
4 Volume	3 Incoming calls			
4 Display	1 Call waiting			
1 Display ⁽¹⁾	2 Auto answer indication			
1 Backlight on activity	3 Reject anonymous			
2 Backlight when idle	4 Silent mode			
3 SmartLabel options	5 DND			
Idle screen				
Call screens	5 Fkeys			
Other screens	1 Context-sensitive keys			
Timer - default display mode	2 Dedicated keys			
Timer - back to page 1	3 SmartLabel keys			
2 Expansion modules ⁽¹⁾	Page 1-4			
1 Backlight on activity	4 Expansion mod. keys ⁽¹⁾			
2 Backlight when idle	6 General			
3 Contrast	1 Quick dial contacts			
4 Appearance	2-4 Quick Lookup			

⁽¹⁾ Only if phone model supports expansion modules and when an expansion module is connected.

⁽²⁾ The administrator password is needed to return the phone to admin mode.

NOTE: The factory default administrator password is 0000 (4 x zero). If it doesn't work, someone changed it. Please ask your administrator or your IP Service Provider.





Most of the individual settings are described elsewhere in this manual: See "Using the phone" on page 50 and "Customizing the phone settings" on page 88.

Display settings



Backlight and contrast on the display of the phone and on the displays of any connected expansion modules can be adjusted separately for the times when the phone is active and when the phone is idle. Lowering backlight intensity lowers the energy consumption of the devices. The backlight when idle can be reduced to zero bars.

NOTE: When the phone has been inactive for a specified number of seconds it will switch the backlight to idle mode. This setting is available only on the phone's web user interface, not on the phone itself. The phone setting is applied to all D3 extension modules connected to the phone, as well.

Adjusting the backlight on the phone's display

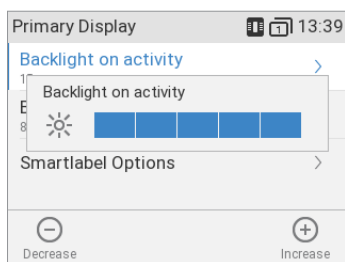
- **Intensity of backlight.** The setting adjusts the intensity of the backlight for both displays.
 1. Press .
 2. Select **Preferences** and press .
 3. Select **Display** and press .
 4. If applicable (i.e., if there is a connected expansion module), select **Primary Display** and press .
 5. Select **Backlight on activity** or **Backlight when idle** and press .



6. Press the right or left arrow on the navigation key or the function key underneath  or  in the function key line to decrease or increase the backlight's intensity.
 7. When done, press  to save and return to the **Display** menu (Fig. 2).
- **Period of inactivity.** The number of seconds after which the phone will switch from backlight on activity to idle backlight can be set on the phone's web interface only.
 1. Open the phone's web interface (see "Opening the web interface" on page 35).
 2. Click **Preferences** (see "How the web interface works" on page 36).
 3. Click the **Display** tab.



4. Enter the number of seconds in the text field of **Dim after (in seconds)**. The default is 20 seconds.
5. Click **Apply** and **Save**.







Adjusting display settings for connected D3s

The intensity of the displays' backlight and the font size of the function key labels is adjusted separately for the phone and the connected D3 expansion modules. Lowering backlight intensity lowers the energy consumption of the devices. You can also switch from the default line layout of the labels to tile layout. For more information on the module's display layout, please refer to its user manual at <https://service.snom.com>, **Accessories > Expansion Modules**.







Note: The number of seconds after which the D3 expansion modules will switch from activity to idle backlight is the number set for the phone display's backlight (see "Period of Inactivity" on page 31).

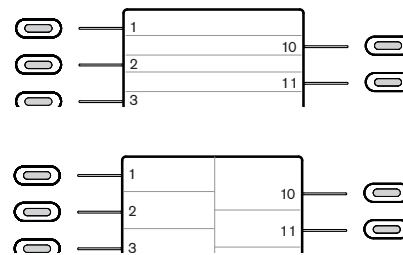
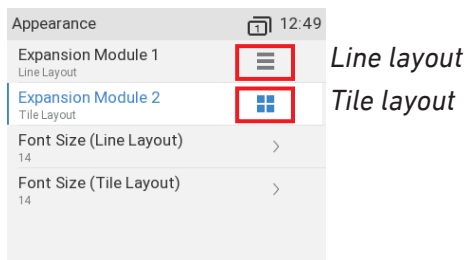



















- **Appearance.**

- **Layout.** The available options are line or tile layout. Line layout is the default. The layout is adjusted separately for each module, and only connected modules appear in the menu. If there is more than one, the first D3 in the daisy-chain is listed as "Expansion Module 1", the second one as "Expansion Module 2", and the third one as "Expansion Module 3".

1. Press .
2. Select **Preferences** and press .
3. Select **Display** and press .
4. Select **Expansion Modules** and press .
5. Select **Appearance** and press .
6. Select **Expansion Module 1, 2, or 3** and press .



7. Press  to change and save the display layout of the selected D3 expansion module, respectively, from lines to tiles and vice versa .
 8. Press  to return to the **Expansion modules** menu; press  for approx. 3 seconds to return to the idle screen.
- **Font size.** As of FW version 8.9.3, it is possible to adjust the font size for the connected expansion modules. The size is set separately for line and tile layout, and the respective setting is applied to all connected modules with line or tile layout, respectively.
 1. Press .
 2. Select **Preferences** and press .
 3. Select **Display** and press .

4. Select **Expansion Modules** and press .
 5. Select **Appearance** and press .
 6. Select **Font size (line layout)** or **Font size (tile layout)**, respectively, and press .
 7. Use the alphanumeric keypad to enter the font size. Press the function key underneath  to delete the character to the left of the cursor if you need to correct your input.
 8. Press  to save the setting and to return to the **Appearance** menu.
- **Intensity of backlight.** The setting is applied to all D3 expansion modules connected to the phone.
 1. Press .
 2. Select **Preferences** and press .
 3. Select **Display** and press .
 4. Select **Expansion Modules** and press .
 5. Select **Backlight on activity** or **Backlight when idle** and press .
 6. Press the right or left arrow on the navigation key or the function key underneath  or  in the function key line to decrease or increase the backlight's intensity.
 7. Press  to save and return to the **Expansion Modules** menu.
 - **Contrast.** The setting is applied to all D3 expansion modules connected to the phone.
 1. Press .
 2. Select **Preferences** and press .
 3. Select **Display** and press .
 4. Select **Expansion Modules** and press .
 5. Select **Contrast** or scroll down to it and press .
 6. Press the right or left arrow on the navigation key or the function key underneath  or  in the function key line to decrease or increase the backlight's intensity.
 7. Press  to save and return to the **Expansion Modules** menu.

The phone's web interface

When the web interface is opened for the first time upon initialization, you will see the **Security** page.

We urge you to set administrator and HTTP passwords to protect your phone. The default administrator password is 0000 (4 zeros); there is no default HTTP password. **Please note:**

- Administrator password. If you do not replace the default administrator password by an individual one, an unauthorized third party with access to the phone could set an administrator password unknown to you. In such a case, you would no longer be able to switch from user mode to administrator mode.
- HTTP user name and password. If you do not set these, you make it easier for experienced hackers to break into your system.

Be sure to write down your admin password and your HTTP user name and password and store them in a secure place.

Without the administrator password, you will not be able to return the phone and the web interface from user mode to administrator mode; many settings will be inaccessible. Without HTTP user name and password you cannot open the phone's web interface.

You can set and change the data on the phone's web interface at any time.

1. Click **Advanced Settings** in the vertical menu on the left side.
2. Click the **QoS Security** tab at the top of the **Advanced Settings** page.

Network Behavior Audio SIP/RTP **QoS/Security** Update

3. Enter the data in the text fields and click **Apply**.
 - Administrator password. Valid values are arbitrary character strings of numerals, letters, and/or special characters of any length. Keep in mind that you may have to enter these characters on the phone's keypad (see "Entering numerals, letters, special characters, and symbols" on page 23). **Write the password down and store it in a safe place!**

Security

Ignore Security Advises on off ?

Use Hidden Tags on off ?

Restrict URI Queries on off ?

Allow CSTA Control on off ?

Empty Client Cert on off ?

Filter Packets from Registrar on off ?

Authentication for SIP Reboot on off ?

Authentication for SIP Check-Sync on off ?

Administrator Mode on off ?

Administrator Password ?

Administrator Password (Confirmation) ?

Minimum PIN Length ?

Maximum PIN Retries ?

- HTTP user name and password. Enter the data in the text fields of the **HTTP Server** section and click **Apply**. The default value is blank.
 - User name. Valid values are character strings of letters and numerals, e.g. **john** or **jh24**.
 - Password. Text string.



HTTP Server

User ?

Password ?

Authentication Scheme Digest Basic ?

Opening the web interface

1. Look up the phone's IP address: Press the function key underneath , if the symbol is available, or press  > **Information** > **System Info** or **Help**.
2. Open a web browser on your PC. Enter the IP address, preceded by "http://" or "https://" in the address bar (for example: http://192.168.10.115) and press ENTER. The home screen opens:

Welcome to Your Phone!

snom

- Operation**
 - Home
 - Directory
- Setup**
 - Preferences
 - Speed Dial
 - Function Keys
 - Identity 1
 - Identity 2
 - Identity 3
 - Identity 4
 - Identity 5
 - Identity 6
 - Identity 7
 - Identity 8
 - Identity 9
 - Identity 10
 - Identity 11
 - Identity 12
 - Action URL Settings
 - Advanced
 - Certificates
 - Software Update
- Status**
 - System Information



This web interface makes it easy for you to set your phone up correctly and to access the advanced features. To dial a number, just enter the number in the field below. You can enter a simple telephone number (e.g. 0114930398330) or URI like info@example.com.

Dial a Number



Outgoing Identity

7760@example.snom.com

Dialed Numbers 

Date	Time	Duration	Costs	Local Identity	Number			
03.09.2020	13:19	00:00:08		7760	7788 7788			



Missed Calls 

Date	Time	Missed	Local Identity	Number			
03.09.2020	13:19	1	7760	7788 7788			

Rejected Calls 

Date	Time	Rejected	Local Identity	Number

Received Calls 

Date	Time	Duration	Costs	Local Identity	Number			
03.09.2020	13:19	00:00:05		7760	7788 7788			

How the web interface works

The vertical menu on the left side of the window is always the same, no matter which window happens to be open at the time. Available menu items depend on whether the phone is running in user or administrator mode.

Click a menu item to open that page. Some pages contain several documents. To make a document visible, click its tab. The font weight of the characters on the active tab is **bold**. Only one tab can be active at a time.

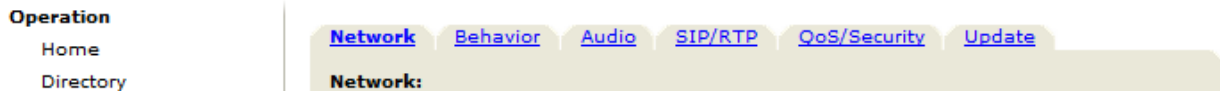

Note: Any changes you make will not take effect until you click **Apply**. Changes will be lost if you open another page of the web interface or if you close the web interface without first clicking on **Apply**.

After you have clicked on **Apply**, in some cases the **Save** button will appear at the top of the page. Click **Save** to save the changes permanently. Changes that have not been saved will be lost if and when the phone loses power or is disconnected from its power source

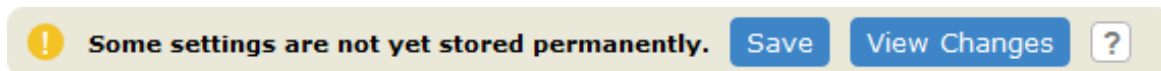

To the right of each setting, there is a link symbolized by the question mark (?). Click this link to open a page with information on the setting (description, valid and default value, links to connected issues, etc.). Click the return button of your browser to return to the phone's web interface.

Note: You may have to enter your HTTP password to return to the phone's web interface.

Web settings overriding manual phone settings

In some cases settings activated on the web interface override manual settings on the phone. If a setting you have made on the phone does not appear to take effect, look for a conflicting setting on the web interface or check with your administrator.

User mode/administrator mode

Snom phones can be operated in administrator or user mode. In administrator mode, all settings are accessible and can be modified; in user mode, a number of settings are not accessible. The factory default is administrator mode.





When the phone is running in user mode, the administrator password is required to revert to administrator mode. The default administrator password is 0000 (4 x zero). We recommend that you change the password for security reasons.

Note: Do not forget to write the new password down and store it in a safe place; without it, a TFTP reset to factory values is necessary to return the phone to administrator mode.

If your phone is administered centrally, user mode may be the rule. Please check with your administrator.

User mode on the phone

The "Network" menu and various other settings are inaccessible in user mode. See "Settings" on page 28. Returning the phone to admin mode from user mode:

1. Press .
2. Select, i.e. if necessary scroll to **Maintenance** and press .
3. Select **Security** and press .
4. Select **Administrator Mode** (Fig. 1), if necessary, and press .
5. Enter the **Admin Mode Password**.
6. Press  to save and return to the **Security** menu where **Administrator Mode** has been changed to "on" (Fig. 2).

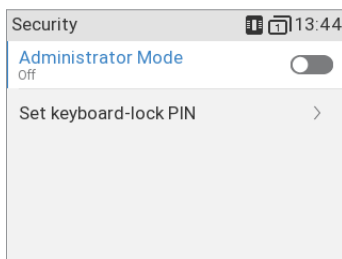

Fig. 1

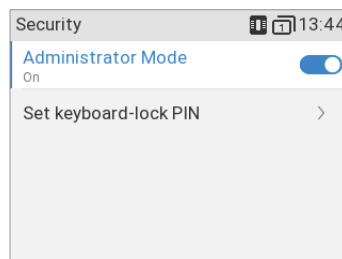

Fig. 2

7. Press  for two seconds to return to the idle screen.

User mode on the web interface

Some windows like **Preferences** are available in user mode while many others, like the identities, are not. The menu item **Advanced** is available in user mode but the settings normally found on the **Advanced Settings** page are not. In user mode the two pages look like this:

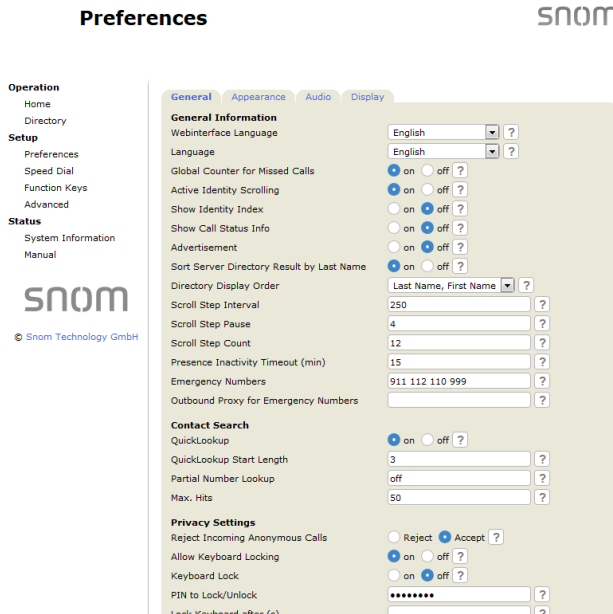

Fig. 1

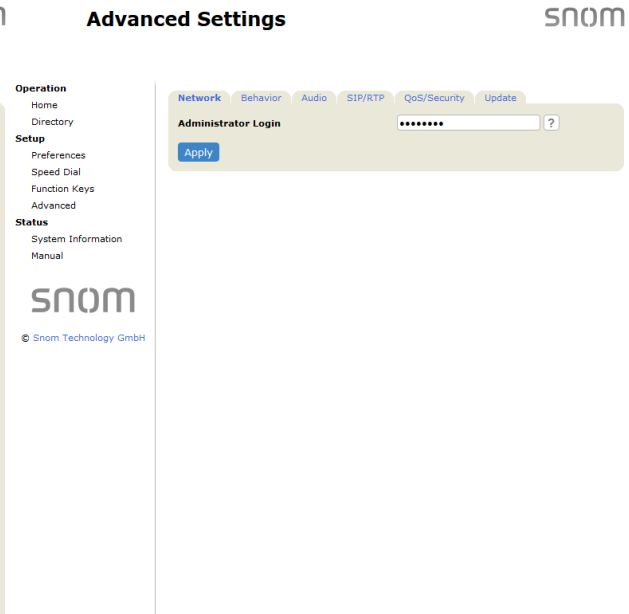

Fig. 2

To return the phone and its web interface to administrator mode, open the **Advanced Settings** page, enter the administrator password in **Administrator Login** and click **Apply** (Fig. 2). The default password is 0000 (4 x zero).

In administrator mode, the two pages look like this:

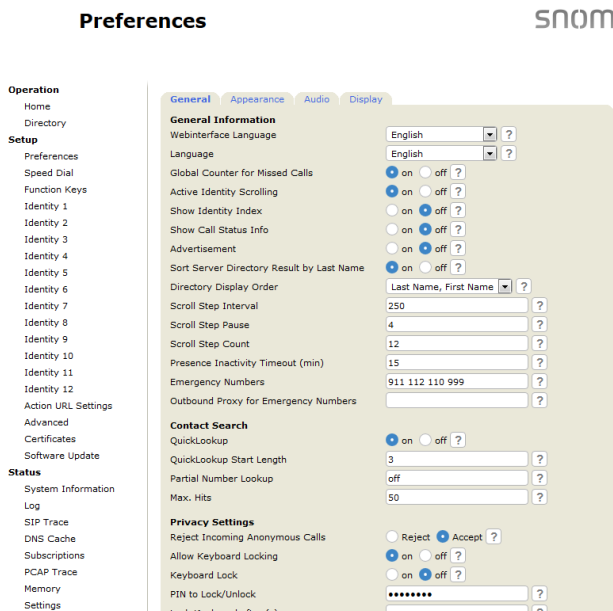

Fig. 3

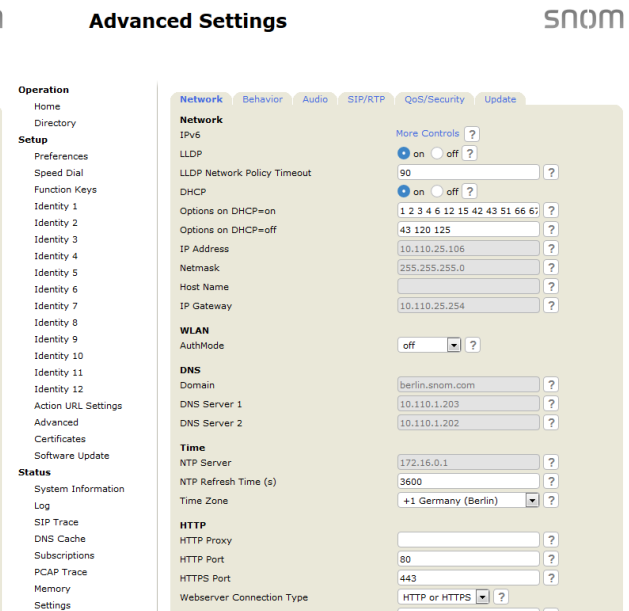

Fig. 4

Directories

Directory

The directory is the built-in directory of the phone. It can hold up to 1000 entries. Entries can be added and edited on the phone and on the web interface.

? Directory						
Name	Number	Contact Type	Outgoing Identity	Edit	Delete	
12345	12345	None	Active			
Jane Smith	9175554105	None	Active			
John Miller						
- sip	9175554230	None	Active			
- Home	9175557015	None	Active			
- Mobile	9175554231	None	Active			

Any changes you make on the web interface will not take effect until you click "Save" or on "Apply" and "Save", depending on your firmware version. Changes will be lost if you open another page of the web interface without first clicking on "Apply"/"Save".

Definitions, explanations

Directory entries

Each entry must have at least one phone number; multiple associated phone numbers are possible. If you do not enter a first and/or last name and/or nickname, the phone number will appear under both "Name" and "Number".

- Entry with one phone number:

Jane Smith	9175554105	None	Active			
------------	------------	------	--------	--	--	--

- Entry with several associated phone numbers:

John Miller						
- sip	9175554230	None	Active			
- Home	9175557015	None	Active			
- Mobile	9175554231	None	Active			

Number area (N): Individual settings for the master record and each subentry possible.

Blue area. Data can be different for each associated phone number. If subentry textfields are blank, the data from the master record is displayed.

Name area. Same data for the master record and all subentries.

Master record (M)	Subentry 1	Subentry 2
<p>? Add or Edit Entry:</p> <p>Number: 4442090</p> <p>Number Type: N sip</p> <p>Contact Type: VIP</p> <p>Outgoing Identity: Active</p> <p>Group: Work</p> <p>Title: Manager</p> <p>Organization: Smith</p> <p>Email: M jd@smithjones.com</p> <p>Note:</p> <p>Photo:</p> <p>Nick Name:</p> <p>First Name: Jane</p> <p>Family Name: M Doe</p> <p>Birthdays: 14.3.</p> <p>Favorite: <input type="checkbox"/></p>	<p>? Add or Edit Entry:</p> <p>Number: 4442091</p> <p>Number Type: N cell</p> <p>Contact Type: VIP</p> <p>Outgoing Identity: Active</p> <p>Group: Work</p> <p>Title: Manager</p> <p>Organization: Smith</p> <p>Email: M jd@smithjones.com</p> <p>Note:</p> <p>Photo:</p> <p>Nick Name:</p> <p>First Name: Jane</p> <p>Family Name: M Doe</p> <p>Birthdays: 14.3.</p> <p>Favorite: <input type="checkbox"/></p>	<p>? Add or Edit Entry:</p> <p>Number: 555557815</p> <p>Number Type: N private</p> <p>Contact Type: VIP</p> <p>Outgoing Identity: 555557815@ser.i</p> <p>Group: S → Friends</p> <p>Title: M → Manager</p> <p>Organization: M → Smith</p> <p>Email: S → jane.d@madeitup.cc</p> <p>Note:</p> <p>Photo:</p> <p>Nick Name:</p> <p>First Name: Jane</p> <p>Family Name: M Doe</p> <p>Birthdays: 14.3.</p> <p>Favorite: <input type="checkbox"/></p>

Blue area of Subentry 2: Different "Group" selection (S), different entry in textfield of "Email" (S). No entry in text fields of "Title" and "Organization", therefore same as Master Record.

Contact Types

VIP: Calls from numbers with this contact type will ring on your phone even when DND mode is active. You can assign a ringtone to this contact type. If your VIP is also assigned to a group (see below) and if that group has a distinct ringtone, the ringtone assigned to the group will be played.

Deny List: Calls from phone numbers with this contact type will not ring on your phone. The caller hears the busy signal. To remove the number from the deny list, you can either

- delete the entry from the directory by clicking on the delete symbol 
- or - if you want to keep the number in the directory - change the contact type to none or VIP by editing the entry. See "Editing existing entry" on page 42 (editing on the phone) and "Editing an entry" on page 45 (editing on the web interface) for more information.

Outgoing identity

The default setting is "Active" which means that the phone will use the current outgoing identity whenever you dial the number of the phone book entry.

You can also select a specific identity to be used as the outgoing identity whenever the number is dialed, for example, if you want to use a specific VoIP provider for these calls.

Note: To use an outgoing identity specified in the directory, you must dial the number from the directory. If you simply type it on the keypad, the current outgoing identity, as indicated on the display, will be used.

Group

The available group types are **Friends, Family, Work, Colleagues**, or **None**. The default setting is none. You can assign a distinct ringtone to each group type.

Ringtones

The phone has 10 built-in ringtones that can be assigned to identities, group types, and contact types. It is also possible to download a custom melody.

Assigning ringtones to identities: See "Assigning ringtones" on page 90.



Assigning ringtones to contact type VIP and group types

1. Open the phone's web interface and click **Preferences** in the menu on the left side of the display.
2. Click the **General** tab.
3. In the **Directory Ringtones** section, select a ringtone from the respective drop-down menu and click **Apply**. If you choose "Custom Melody URL", enter the URL to the data file in the text field. It must be a file of the type PCM 8 kHz 16 bit/sample (linear) mono WAV.



Note: Ringers assigned to contact type VIP and to any of the group types override the ringers assigned to the identities. For example, if you have assigned ringer 1 to one of the identities and ringer 2 to the group "Colleagues", the phone will play ringer 2 when a contact from the "Colleagues" group calls that identity.

Adding/Editing Entries on the Phone

Adding new entry manually

1. Press  to open the phone's directory.
2. Press the function key underneath .

Note: See "Input modes and navigation" and "Entering numerals, letters, special characters, and symbols" on page 23 for information on how to enter data.



3. Enter the phone number and press .
4. Enter a first name and/or press .
5. Enter a last name and/or press .

Note: Entering a first and/or name is optional. If you don't enter either one, the entry will be listed under the phone number. You can add a first and last name later by editing the entry on the phone or on the web interface.

6. See "Editing existing entry" on page 42 on how to continue.

Adding new entry from call list

For further information on call lists, see "Call lists" on page 63.

1. Press the function key underneath  to open the call history. The list of **all** calls appears.
 - Press  /  on the navigation key to show the lists of **missed**, **received**, or **dialed** calls instead.

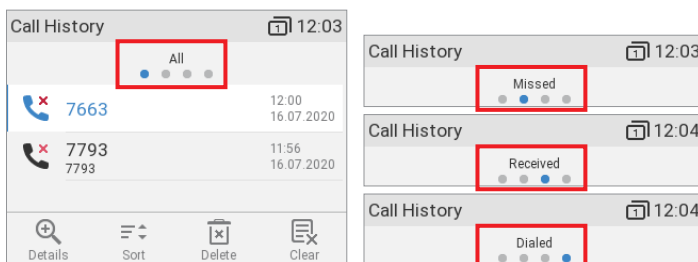

2. Press  /  on the navigation key to select a call.

3. Press  to view call **Details**.

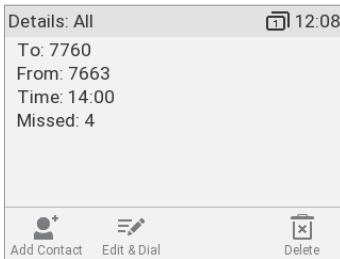



4. Press  to add the name (if the name was transmitted) and the number to the phone directory. If the name has not been transmitted, the number will be used in its place.





See "Editing existing entry" on page 42 on how to add a name, phone type, group, etc.

Adding current caller







With the call on the line, you can add the caller's name (if transmitted) and phone number to the directory. If the name has not been transmitted, the number will be used for both name and number. See "Editing existing entry" on page 42 on how to add a name, phone type, group, etc.

1. With the call on the line, press .
2. Press  to add the caller to the directory.







Sorting entries

1. Press  to open the phone's directory.
2. Press .
3. Use   to select the criterion for sorting (nickname, first name, last name, organization, etc.) and press  to sort.



Editing existing entry

1. Press  to open the phone's directory.
2. Selecting an entry: Scroll to the entry or enter the first letter of the name.
3. Press . The **Details** screen for the entry will be displayed.
4. Editing a detail.
 - a. Press  /  and  to select a detail. Depending on the detail,
 - b. In some cases, you will see the prompt screen where you can enter or modify text. Edit the data, if necessary, and press  to save and to open the next screen. See also "Entering numerals, letters, special characters, and symbols" on page 23.

In other cases, you will see a succession of screens with context-sensitive buttons. Example: Modifying the settings of "group".

- i. Select "group" with  /  and .
 - ii. Use  /  to select family, friend, colleague, work, or none.
 - iii. Press  to save and return to the Details menu.
- c. When you are done editing the entry, press .

Deleting an entry

1. Press  to open the phone's directory.
2. Selecting an entry: Scroll to the entry or enter the first letter of the name.
3. If you want to delete the entry, press  (Fig. 1) and **continue with step 4**, below.

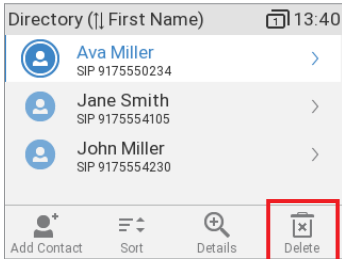

Fig. 1

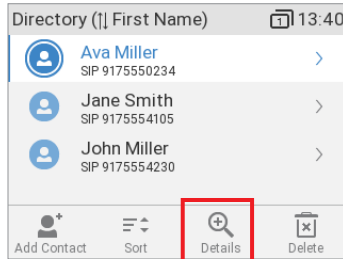







Fig. 2

- a. If there is **more than one phone number** associated with the entry and you want to delete only one of them, press  (Fig. 2) or .
- b. Select the number you want to delete with  /  (Fig. 3) and press . You will see the details of the subentry (Fig. 4).
- c. Press .

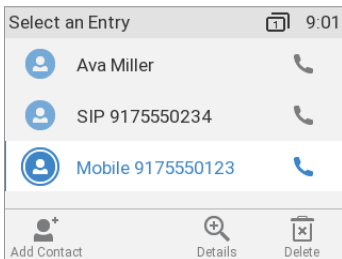

Fig. 3

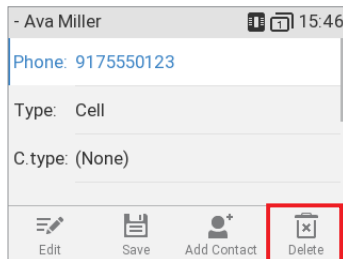

Fig. 4

4. You will be asked, "Are you sure?".

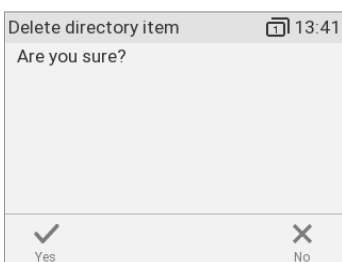

Fig. 5

5. If you are, press  to delete the entry or phone number.

Adding/editing entries on the web interface

Click **Directory** in the menu on the left side.

Adding new entry

1. Type data in text fields of **Add or Edit Entry**.

- **Number:** Type the number exactly as you would dial it, with country and area codes, if necessary, and without parentheses, hyphens, blank spaces.
 - Note:** If the directory already contains the number you have entered, the existing directory entry with that number will be overwritten when you save the new entry.
- **Number Type:** Select the type of connection from the drop-down menu. The default setting is SIP.
- **Contact Type:** Select "None", "VIP", or "Deny" from the drop-down list. The default setting is "None".
 - Calls from entries on the "VIP" list will always ring on the phone, even when the phone is in a call or in DND mode.
 - Note:** You can assign a distinct ringtone to the contact type "VIP": **Preferences** page > **Directory Ringtones** section.
 - Calls from entries on the "Deny" list will not ring on the phone. The caller will always hear the busy signal.
- **Outgoing Identity:** The drop-down list shows all identities configured on the phone. If you select one of the identities for one of the numbers listed in the phone book, all calls to that number initiated from the phone book will show that identity on the callee's phone.
- **Blue area:** The data entered in the textfields will be displayed when the entry is opened on the phone. The data can be used to sort entries by group, name, organization, etc., and can be edited on the phone.
 - "Group" drop-down menu: Available types are "Friends", "Family", "Colleagues", or "Work". You can assign a distinct ringtone to each group type: Preferences > Directory Ringtones.
 - "Nickname": If you enter a nickname, it will appear under the "Name" header of the **Directory** on the web interface.
- **First name, family (last) name:** Will be added in this order under "Name" in the directory, unless you have also entered a nickname.

- **Birthday.** Uses the format set at **Preferences > General information > U.S. Date Format (mm/dd)**: "On" or "Off". Enter in DD.MM.YR or MM/DD/YR format. Examples:

Date	Input	Output when US Date Format setting is	
		On	Off
March 5, 1980	5.3.80 or 3/5/1980	03/05/80	05.03.80
March 12, 1980	12.3.80 or 3/12/1980	03/12/80	12.03.80
October 5, 1980	5.10.80 or 10/5/1980	10/05/80	05.10.80
October 12, 1980	12.10.80 or 10/12/1980	10/12/80	12.10.80

- **Favorite:** Tick box to add entry to "Favorites" list.

2. Click **Add/Edit** to save new entry to directory.

Editing an entry

When you open an existing entry, the current information is displayed in the text fields of "Add or Edit Entry" and two additional buttons, "Add Sub" and "Change", are available (see Fig. 2 and 3, below).

- Editing.













Jane Smith	9175554105	None	Active			
John Miller						
- sip	9175554230	None	Active			
- Home	9175557015	None	Active			

Fig. 1

- If single entry, click  in the entry's line.
- If there is more than one number associated with a name:
 - Click  in the name's line if you want to edit/add the first or last name of the date of birth and the data in the blue area applicable to the master record.
 - Click  in a phone number's line if you want to edit the subentry's data (phone number, number & contact type, outgoing identity, and any blue area data applicable to this subentry only).

Make changes as necessary and click **Change**.

- Adding additional phone number (subentry) for a name
 - Jane Smith's entry has only one phone number, her SIP phone number. In this example, the phone number of Jane Smith's landline will be added to the directory.
 - Click  in Jane Smith's line (Fig. 1, above). The data is shown in "Add or Edit" area (Fig. 2).

Fig. 2

Fig. 3

- Enter the phone number in the text field of "Number" (Fig. 3).
- Select "fixed" from the drop-down menu of "Number type" (Fig. 3).
- Optional: Select a contact type and an outgoing identity from drop-down lists (Fig. 3).
- Click **Add Sub** (Fig. 3).
- o John Miller's entry has a SIP number and a private number. In this example, his cell phone number will be added as a third number.
 - Click  in the line containing John Miller's name. The data is shown in "Add or Edit" area.

Fig. 4

Fig.5

- Enter the phone number in the text field of "Number".
- Select the number type.
- Optional: Select a contact type and an outgoing identity from the respective drop-down list.
- Click **Add Sub**.

The directory now contains Jane Smith's landline number and John Miller's mobile phone number (Fig. 6).

? Directory						
Name	Number	Contact Type	Outgoing Identity	Edit	Delete	
12345	12345	None	Active			
Jane Smith						
- sip	9175554105	None	Active			
- Landline	9175554129	None	Active			
John Miller						
- sip	9175554230	None	Active			
- Home	9175557015	None	Active			
- Mobile	9175554231	None	Active			

Fig. 6

Deleting entry on web interface

- Entry with one phone number. Click in the entry's lines to delete the entry.
- Entry with more than one phone number.
 - Deleting the entry. Click in the line of the master record to delete the name and all associated phone numbers.
 - Deleting one of the phone numbers. Click in the line of a phone number subentry to delete that subentry, but keeping the master record and all other subentries.

Dialing from phone directory

To dial, click the phone symbol on the right side of the line with the phone number.

Deleting whole directory

Deletes the entire directory irretrievably!

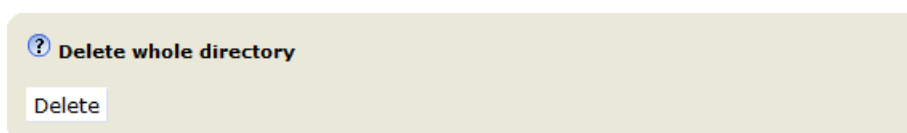

Importing a directory

1. Click **Choose File** and select the file from your PC or server.

2. If the file has headers, select **on** to **Skip First Line**.
3. Click **Load**.

Exporting the directory

Click [here](#) to save the current directory.

Click [here](#) to save the current directory in XML format.

You can save/export the directory in two formats: tbook.csv (first line) and XML by clicking the respective link.

External directories

Available if provided by your network, your VoIP provider, or another external source.

LDAP

Enter the necessary data received from your administrator, VoIP provider or other external source in the text fields of the phone's web interface, **Advanced Settings** page, **Network** tab, **LDAP** section, and click "Apply" and "Save".

LDAP search on the phone: Enter the first letter of the name you are searching for. Type more letters if the name shown isn't the right one or scroll through the list. Press  to dial.

Contacts

If you want to use an external contacts list, the **Contact list** and **Contact list URI** settings are mandatory. **Publish presence** is optional; when enabled, the phone sends out "PUBLISH" SIP messages with the phone's status, e.g. busy, etc.

1. On the phone's web interface, **Configuration Identity #** page, **SIP** tab, click the radio button **on** of the **Contact list** entry.
2. Enter the URI received from your administrator, VoIP provider or other external source in the text field of **Contact list URI**.
3. Optional: Click the radio button **on** of the **Publish presence** setting.
4. Click **Apply** and **Save**.

[Login](#) [Features](#) [SIP](#) [NAT](#) [RTP](#)

SIP Identity Settings:

Voice Quality Report Collector: ?

Music on hold server: ?

Send hold as inactive: on off ?

Alert Info URL: ?

User picture URL: ?

Dial-Plan String: ?

Count all groups in Dial-Plan: on off ?

ENUM Support: on off ?

Countrycode: ?

Areacode: ?

Proxy Require: ?

Additional supported headers: ?

Q-Value: 1.0 ?

Proposed Expiry: ?

Auto Answer: on off ?

Long SIP-Contact (RFC3840): on off ?

Support broken Registrar: on off ?

Shared Line: on off ?

Publish Presence on bootup: on off ?

DTMF via SIP INFO: off ?

Send display name on INVITE: on off ?

Extension Monitoring Call Pickup List URI: ?

Contact List: on off ?

Publish Presence: on off ?

Contact List URI: ?

To dial a contact on the phone, enter the first letter of the name you are searching for. Type more letters if the name shown isn't the right one, or scroll through the list. Press  to dial.

Using the phone

This section describes the functions of the phone with the factory default settings. If your phone was installed and/or set up by someone else, the default settings may have been changed. Please check with that person or company if the phone does not react as described here.

The caller information displayed on the screen is controlled by a setting on the phone's web interface. The default setting is "Name". You can change the setting on the **Preferences** page, **General Information** tab, **Number Display Style** setting by selecting a different option from the drop-down list.

Making calls

See "Entering numerals, letters, special characters, and symbols" on page 23 for information on input modes and entering letters, numerals, and special characters.

Selecting identity for current outgoing call

See "Identities/accounts" on page 88 on how to configure identities.

If more than one identity is shown on the display, the one on the white bar with the white and green rings around the green circle is the outgoing identity for the call and the number/name that will show on the callee's phone. Use the up or down arrow on the navigation key to select another identity.

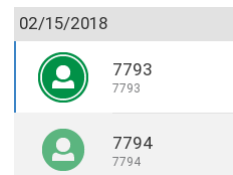

Using different audio devices

Handset

- Pick up the handset, enter the phone number, and press  OR
- enter the phone number and pick up the handset.

Headset



Enter the phone number, and press .

Speakerphone

Enter the phone number and press  or .

Handset or headset and casing speaker

With dual audio mode activated, other persons present in the room are allowed to listen in to the third party over the phone's casing loudspeaker.

1. Use the method for handset or headset use to dial.
2. When the call has been established, press  to enable the casing loudspeaker. Press  to turn the speaker off.





Using different dialing methods

Auto dial







When the setting is enabled, the phone will dial the number on the display when the specified number of seconds has elapsed since the last digit was typed.

Note: The default setting is off. In admin mode, the setting can be enabled on the **Advanced Settings** page, **Behavior** tab, **Phone Behavior** section, **Auto Dial** setting by selecting a time span in seconds from the drop-down menu.





Redialing

1. Press  to show the last numbers dialed, with the very last number at the top.
2. Press  to dial that number or use / to select a different number and then press .

Calling number from call history (missed, received, dialed calls)

1. Press  (dialed calls),  (received calls), or  (missed calls) to open the respective call list.
2. Use / to select a call.
3. Press  to dial the number.

Calling number from phone directory

1. Press  to open the phone's directory.
2. Use / to select a name or enter the first letter(s) of the name on the alphanumeric keypad.
3. Press  to dial the number.

Calling number from external directory

1. Open the dial screen to get access to the external directory, if available:
 - a. Lift the handset off the cradle or press the speakerphone key to open the dialing screen (Fig. 1).
 - b. Press the function key underneath  to show the list of available directories and call lists (Fig. 2).

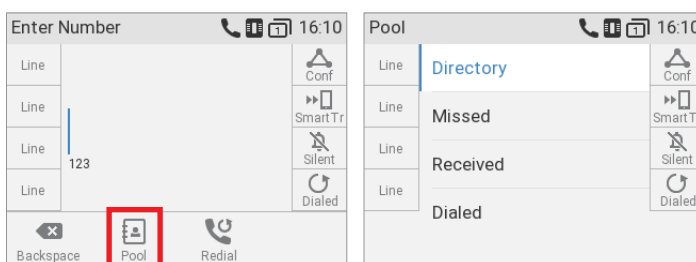

Fig. 1

Fig. 2

- c. Select the external directory.

2. Use \checkmark/\wedge to select a name or enter the first letter(s) of the name on the alphanumeric keypad.
3. Press D to dial the number.

Speed dialing

Setting speed dial numbers: See "Speed dial" on page 100. Mapping a speed dial number onto one of the freely programmable function keys: See chapter "Configuring the function keys", "Example 3, Speed dialing" on page 80.

- Speed dial number on speed dial list
 1. Enter the speed dial number (0-30) or character (#, *) assigned to the phone number you wish to dial.
 2. Press D to dial.
- Speed dial number mapped onto freely programmable function key 1-32: Select the page, if necessary, and press the key.

Calling emergency numbers

Numbers specified as emergency numbers can be dialed even when the keypad is locked. See "Emergency numbers" on page 94 on how to set emergency numbers. Several numbers (911, 112, 110, 999) have been preconfigured.

- On an unlocked keyboard: Enter the number and press D to dial.
- On a locked keyboard: Enter the number. The phone dials the number as soon as you have entered all the digits of one of the programmed emergency numbers.

Call completion

This function depends on whether it is available in your network or not. On Snom phones call completion means that when a called number is busy or not available, you can have your phone call you back as soon as the dialed number is not busy anymore or available again. The factory default setting is "off".

Changing the setting to turn on call completion : See "Call completion" on page 96.

1. When call completion is enabled, the symbol D will appear in the function key line whenever you dial a number (Fig. 1). Press the key underneath D to activate call completion for this call.

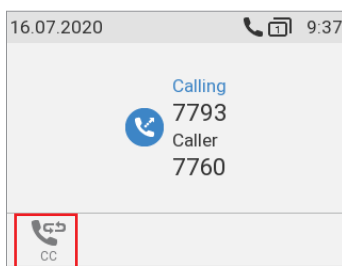

Fig. 1

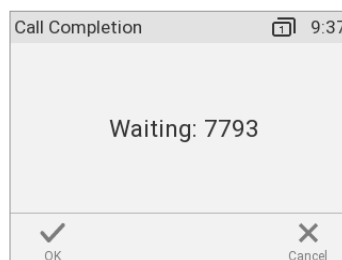

Fig. 2

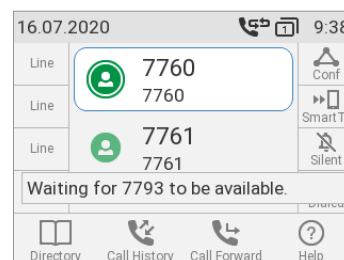





Fig. 3

2. Press  /  if you wish to dial another number while waiting for call completion (Fig. 2). You can now hang up the handset to return to the idle screen (Fig. 3); use handset, headset, or speakerphone to dial another number; receive calls etc. Call completion will not interfere with the normal operation of your phone.

If you want to turn off call completion for this call, press  / .

3. When the number becomes available, you will see it announced on the display (Fig. 4) and hear a double beep if you are in a call.

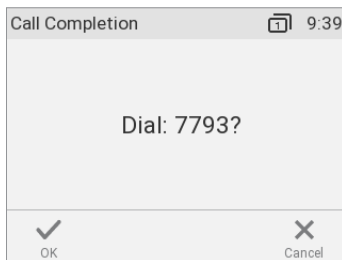





Fig. 4

4. Press  /  to dial, or press  /  to turn off call completion for this call.

QuickLookup (number guessing / auto completion)

When the function is enabled, the phone proposes numbers containing the typed string from the numbers saved on its call lists and in the directory as soon as you have typed the minimum number of digits. If there is more than match, select with  /  on the navigation key and press  to dial.

The default setting as of firmware version 10.1.33.33 is enabled, and the minimum number of characters that must be entered before QuickLookup starts looking for matches is three.

Changing the minimum number of characters or turning the function off: See "QuickLookup (number guessing / auto completion)" on page 99.

In the following example, the minimum number of characters is four.

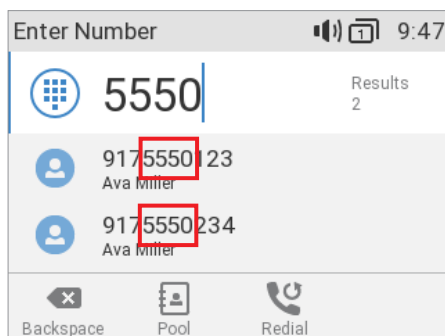

Note: In earlier FW versions, the default setting for the number guessing/auto completion function is **off**. To enable it, open the phone's web interface to the **Advanced Settings** page, **Behavior** tab (available in admin mode only). In the **Phone Behavior** section, change the **Number guessing** setting to **on**, and enter the minimum number of characters that must be entered before number guessing will start.

Accepting calls

Using different audio devices

Handset: Pick up the handset.

Headset: Press . If the phone is already in headset mode, you can also press the blinking line key.

Speakerphone: Press  or the blinking line key.

Automatically accepting calls

When the function is enabled, the phone will automatically accept incoming calls on speakerphone when it is idle. Press the headset key  if you want them to go to the headset. The default is **off**.

Turning the function on (admin modus only): On the phone's web interface, **Configuration Identity #** page, **SIP** tab, **Auto answer** setting: click the radio button **on**.

If you want to be alerted acoustically by a single long beep whenever the phone accepts an incoming call, you need to change another default setting on the phones's web interface from **off** to **on**: **Preferences** page, **Auto Answer** section, **Auto Answer Indication** setting.

Call pick-up from another extension

You can pick up calls ringing on another extension, for example when the other extension is busy or when the user is absent, when the following prerequisites for this function are met:

- It must be supported by the PBX.
- The extensions whose calls you want to pick up on your own extension must permit this function. It is possible but not required to restrict the permission for monitoring to certain users or groups of users.

Settings: See chapter *Configuring the function keys*, "Example 1, Extension monitoring and call pick-up" on page 77.

- Each extension to be monitored must be programmed onto one of the freely programmable function keys with LEDs on the phone or a connected D3 Expansion Module. See chapter *Configuring the function keys*, "Example 1, Extension monitoring and call pick-up" on page 77 and "Example 2, Extension monitoring and call pick-up on D3 expansion module" on page 79.
- If you want to see who is calling or connected to any of your monitored extensions, the function "Go to call monitor on activity" must be enabled on the phone's web interface, **Advanced Settings** page, **Behavior** tab, **Go to call-monitor on activity** setting. Click **on**.

When these prerequisites are met, the status of the monitored extension is indicated by the LED of the function key:

- Blinking LED: Incoming call ringing. If the call is not answered, press the key to pick it up;
- LED glowing steadily: The monitored extension is busy (in call, dialing, etc.);

and by the idle display showing the call-monitor state.

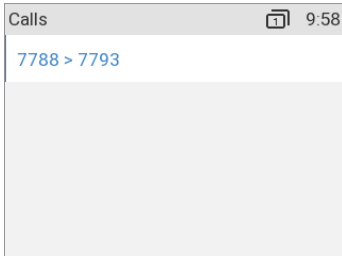

Fig. 1

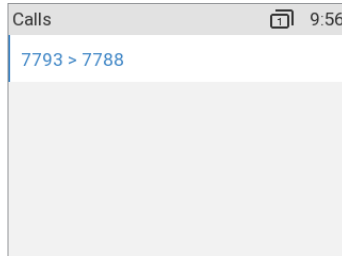

Fig. 2

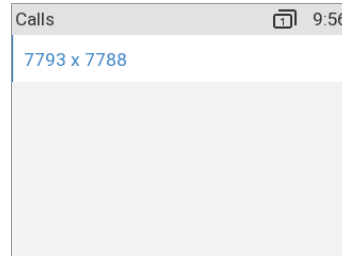

Fig. 3

- When your phone is idle, any ongoing activity on all extensions monitored by your phone will be shown on the display. In the above examples, "7788 > 7793" (Fig. 1) indicates that a call from 7788 is ringing on monitored extension 7793. In Fig. 2, "7793 > 7788" (Fig. 1) indicates that monitored extension 7793 is calling extension 7788; in Fig. 3 "7793 x 7788" (Fig. 3) indicates that 7793 is connected to 7788 and that 7793 is the caller, 7788 the callee.
- Press to close the **Calls** screen and return to the idle screen.

Call waiting

When you are in a call, another call coming in will be announced visually by the flashing call LED and by the symbol / appearing in the function key line (Fig. 1); it will also be announced acoustically by a double beep. If you want to switch to visual or acoustic announcement only or turn call waiting off completely, see "Call waiting" on page 97.

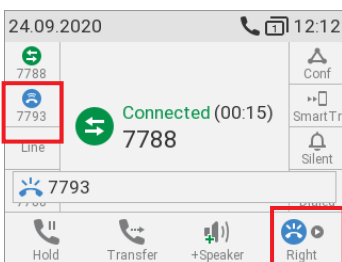

Fig. 1

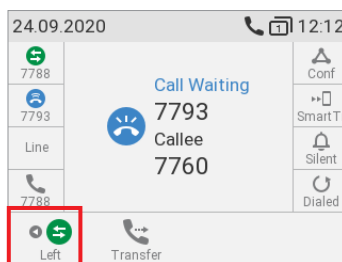

Fig. 2

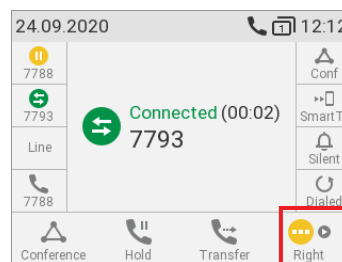

Fig. 3

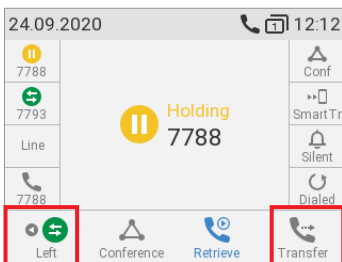

Fig. 4

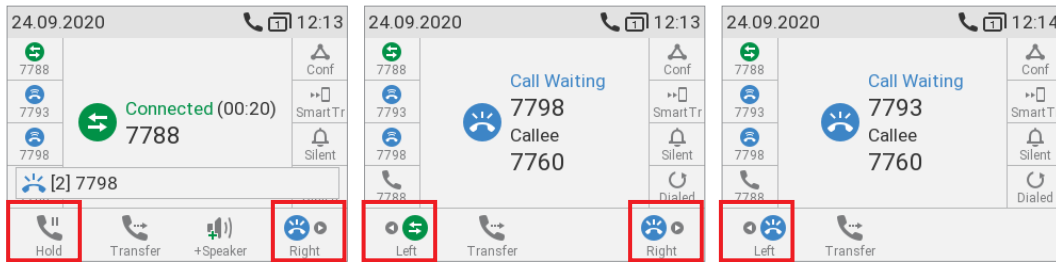

Fig. 5

Fig. 6

Fig. 7

When a call is waiting, you have the following options:

- Press the blinking line key of the call waiting to put your current call on hold and to accept the second call without knowing who is calling. This option is available only when there is a free line key available at the time the call comes in.
- Press the function key underneath (Fig. 1) to put the **Call waiting** screen on the display (Fig. 2); you will see the caller ID on-screen if it is being transmitted.
 - Press to reject the call waiting. The caller will hear the busy signal.
 - Press to accept the second call and put your current call on hold.
 - Press to return to the **Connected** screen with your current connection.

Note: Pressing and will affect the call shown on the display, i.e., your current connection in Fig. 1 and 3, the call waiting in Fig. 2, 5, and 6 or the call on hold in Fig. 4.
 - If there is more than one call waiting (Fig. 5, 6, and 7), press the keys or , respectively, to bring them on-screen and to return to the connected call.
- If you do not wish to accept the waiting call, you can:
 - ignore the announcement. If you have set call forwarding when busy, the call will be transferred to that phone.
 - reject the incoming call by putting the **Call waiting** screen on the display and pressing . The caller hears the busy signal. Pressing for three seconds will also put the caller on the "Deny" list of the phone's directory. Future calls from this number will not ring on the phone; the caller hears the busy signal. For more information on the "Deny" list and how to remove entries from it, see "Contact Types" on page 40.

Active calls

Hold

One call on hold

Press  to put the ongoing call on hold. Held calls are indicated threefold:

- By the text on the display.

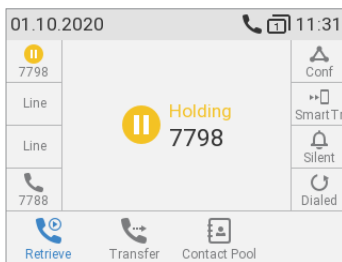



- By the slowly blinking line key.
- By the slowly blinking call indication LED.
- By the double beep.





You can now:

- transfer the held call blindly or with prior announcement - see "Transferring calls" on page 59.
- receive and make calls and put other calls on hold.

Pick up the held call by pressing its line key or by pressing  again. If the other party hangs up while on hold, the call is terminated on your phone as well and the LED indicators are turned off.

Holding multiple calls

When you are in a call with one party and have one or more calls on hold and when there is more than one call on hold, the symbol  /  is available in the function key line. You can switch back and forth between the active call and any call on hold. Up to 12 simultaneous calls are possible, if supported by the PBX.

- In Fig. 1–3 the phone is in one active call with a second call on hold. Fig. 1 and 2 both show the connected call, in short label display mode (Fig. 1) and in full label display mode (Fig. 2). Press the function key underneath  /  or  /  to show the call not currently on screen.

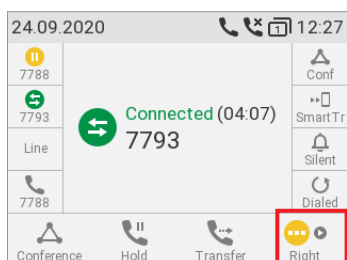

Fig. 1

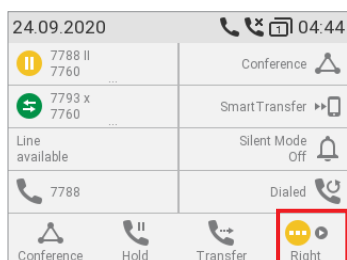

Fig. 2

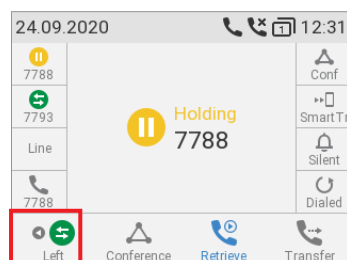

Fig. 3

- In Fig. 4–6 there are two calls on hold. Fig. 5 and 6 both show the second held call, in short label display mode (Fig. 5) and in full label display mode (Fig. 6). Press the function keys underneath or or to show the call not currently on-screen.

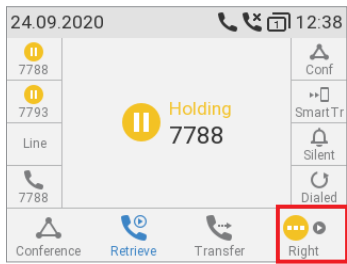

Fig. 4

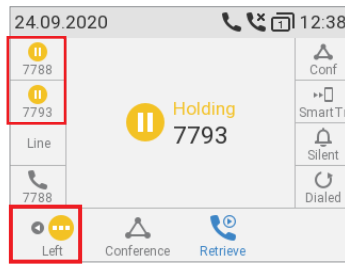

Fig. 5

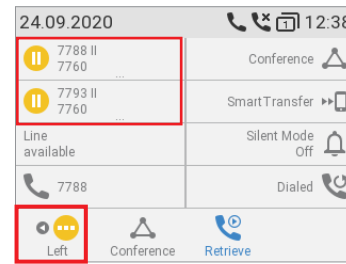

Fig. 6

- When the connected call is on-screen, you can transfer it to a third party or terminate it by pressing .
- When a held call is on-screen, press to connect to it and put the currently connected call on hold.

Conference

The maximum number of participants is three.

Note: This section refers to phone-based conferences. For the number of participants in server-based conferences and how to set them up and participate, please check with your network administrator or your VoIP provider.

Initiating a conference

1. Call the first intended participant and put him or her on hold.
2. Call the second intended participant.

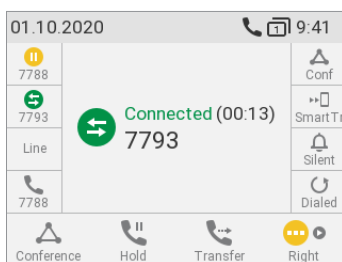

Fig. 1

3. When you are connected to the participant, press to start the conference.

Conference screen navigation

Your input on the phone's keys will affect the caller/callee(s) or the entire conference shown in the contact area of the display. Example: A conference with three participants, including yourself. After you have pressed (Fig. 1) to start the conference, the names, if available, and/or phone numbers of the other participants are shown on-screen (Fig. 2–4). Fig. 2 shows the conference screen, i.e., all of your conference partners while Fig. 3 and 4 show the screens for the individual participants.

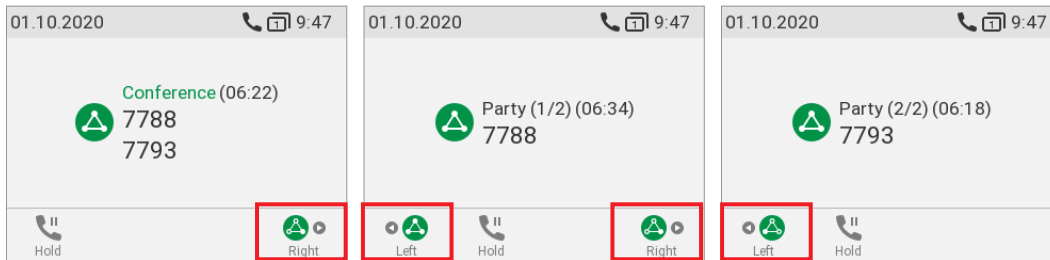

Fig. 2

Fig. 3

Fig. 4

- Selecting individual participants.
 - On the conference screen (Fig. 2), press on the navigation key or the function key underneath / to select the first of the participants of the conference; press / / again to select the next one of the participants (Fig. 3).
 - When viewing the second participant (Fig. 4), press / / to view the first participant.
 - When viewing the first participant (Fig. 3), press / / to return to the conference screen.
- Talking to one participant in private. With one of the participants on-screen (Fig. 3 or 4), press to converse with that participant in private and to put the other party on hold. To restart the conference, press .
- Putting one participant on hold. With one of the participants on-screen (Fig. 3 or 4), press to put this party on hold and to converse with the other party in private. To restart the conference, press .
- To terminate the conference and the connections to both parties, return to the conference screen (Fig. 2) and press .

Transferring calls

You can transfer connected calls as well as calls ringing on your phone.

- When you have a call on the line, there are two ways to transfer it to a third party:
 - Announcing the call to the third party first, to make sure the call is welcome and will be accepted: Attended transfer;
 - Transferring the call unannounced: Blind transfer. There will be no feedback on whether the third party is available and/or picking up the call.
- When a call is ringing on your phone, you can transfer it to a third party without answering it first (blind transfer only).

Attended transfer

- With a single call on the phone.
 1. Put the call on hold (Fig. 1). In our example, the caller on hold is 7788.

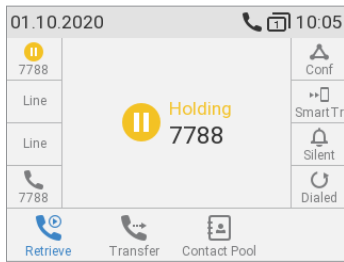

Fig. 1

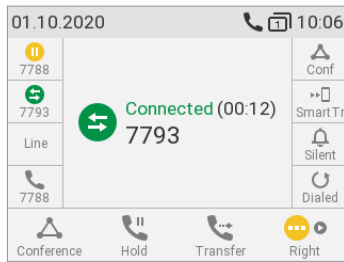

Fig. 2

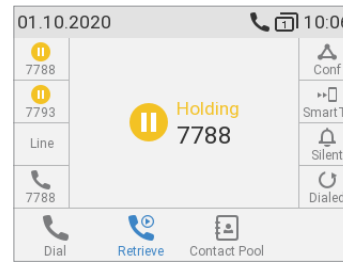

Fig. 3

2. Dial the number you want to transfer the call to and announce the call (Fig. 2). You can also select a number from the internal or one of the available external phone directories (see "Calling number from phone directory" and "Calling number from external directory" on page 51).
 3. If the third party wants to accept the call, press . The "holding 7750" screen appears (Fig. 3).
 4. Press to complete the transfer. You may briefly see the messages "Disconnected 7793" and "Disconnected 7788", indicating that the transfer was completed.
- With more than one call. All calls must be on hold. In the below example you have two calls from phone numbers 7788 and 7798 on hold. You want to transfer the call from 7798 to 7793.

1. Dial 7793 and announce the call.
2. If the third party wants to accept the call, press . If the "holding 7788" screen, i.e., the call you **do not** want to transfer, appears on-screen (Fig. 4), press / to bring "holding 7798" on-screen (Fig. 5).

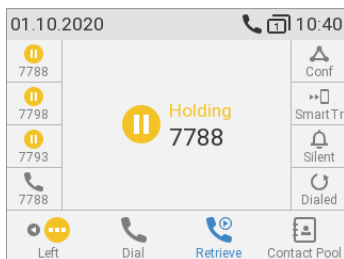

Fig. 4

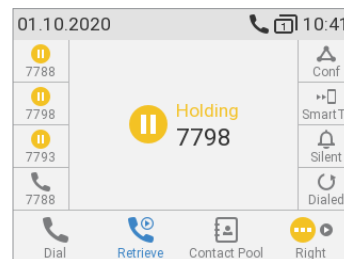

Fig. 5

3. Press . You may briefly see the messages "Disconnected 7793" and "Disconnected 7798", indicating that the transfer was completed. The remaining call on hold or the first of the remaining calls on hold will then appear on-screen (Fig. 6).

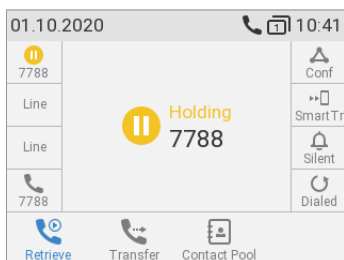

Fig. 6

Blind transfer

- **Blind transfer of active call**

1. With a call on the line (Fig. 9), press . The dial screen will appear.

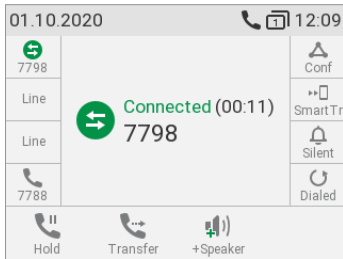

Fig. 9

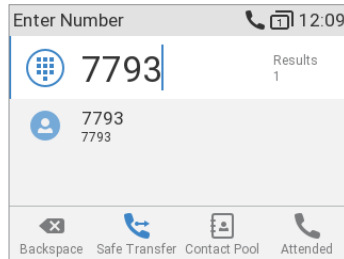





Fig. 10

2. Dial the number (Fig. 10), or press  to select a number from the internal or one of the available external phone directories (see "Calling number from phone directory" on page 51 and "Calling number from external directory" on page 51).

Note: If a call is waiting (Fig. 11), as indicated by the symbol  /  in the lower right corner, you must reject it before you can transfer your active call blindly.

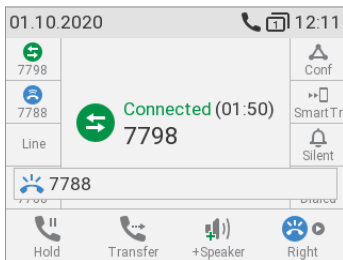

Fig. 11

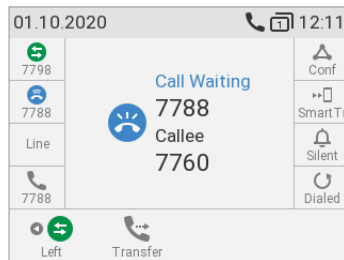







Fig. 12

- a. Press the function key underneath  / . The "Call Waiting" screen (Fig. 12) appears.
 - b. Press  to reject the call waiting. The caller hears the busy signal.
3. Press . You may briefly see two "Disconnected" messages followed by the callee and caller's name/number, indicating that the transfer was completed (Fig. 6 and 7 on the preceding page).

- **Blind transfer of call waiting**

1. If you are in a call and want to transfer a call waiting (Fig. 13), press the function key underneath  / . The "Call Waiting" screen (Fig. 14) appears.

Note: Your active call will remain active while you are transferring the ringing call.

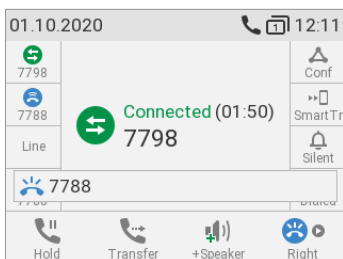

Fig. 13

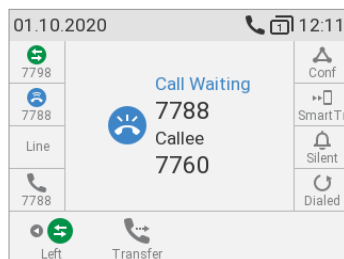



Fig. 14

2. Press . The dial screen appears.
3. Enter the number of the third party you intend to transfer the call to and press . The "Connected" screen with your active call appears.

• **Blind transfer of ringing call**

1. With a call ringing (Fig. 15), press .

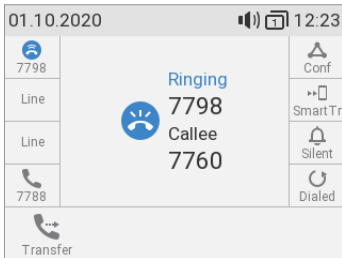

Fig. 15

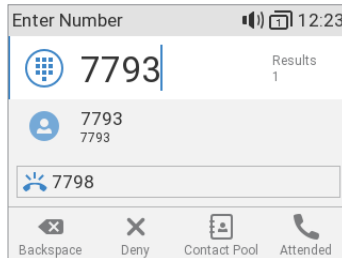





Fig. 16

2. The dial screen (Fig. 9, above) appears.
3. Enter the number of the third party you intend to transfer the call to and press .

Terminating calls

- When using the handset: Place the handset in the cradle or press .
- When using speakerphone or a headset: Press .

Missed Calls

Missed calls are indicated by the call LED (steady light), the missed call symbol in the status line, and by the "Missed" message with the number of missed calls on the display (Fig. 1) and on the Status info screen (Fig. 2).

Note: If there are status messages with a higher priority, the status line will show the message with the highest priority.

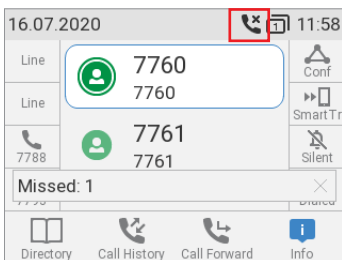

Fig. 1

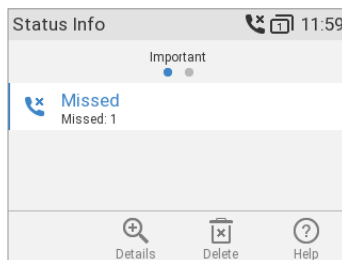

Fig. 2

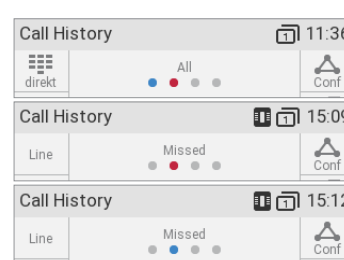







Fig. 3

- To view your missed calls, press the right arrow  on the navigation key. The red dot indicates the arrival of new missed messages since the last time the missed calls were viewed (Fig. 3). It is removed from the list of all calls and turns blue in the list of missed calls once the list has been viewed.

- Turning off the missed call indications (LED and "Missed" message). Use one of the following methods:
 - View the list of missed calls.
 - Via the **Status info** screen.
 1. Press , if available (Fig. 1), or open the **Settings** menu  > **Information** > **Status Info** to view the status info messages.
 2. Press the function key underneath  to delete the "Missed" message line (Fig. 2). If there are other status info messages, you may need to use the up/down arrows  on the navigation key to select the "Missed" message line.

Note: This will only remove the status message "missed" and turn off the LED. The call will remain on the missed calls lists.

Call lists

Three call lists of missed, dialed, and received calls are stored on the phone. They contain the number, time and date, and duration of the calls. If the memory allotted to the storing of call lists is full, the oldest ones will be overwritten.

1. Press  to open the call history (Fig. 1).

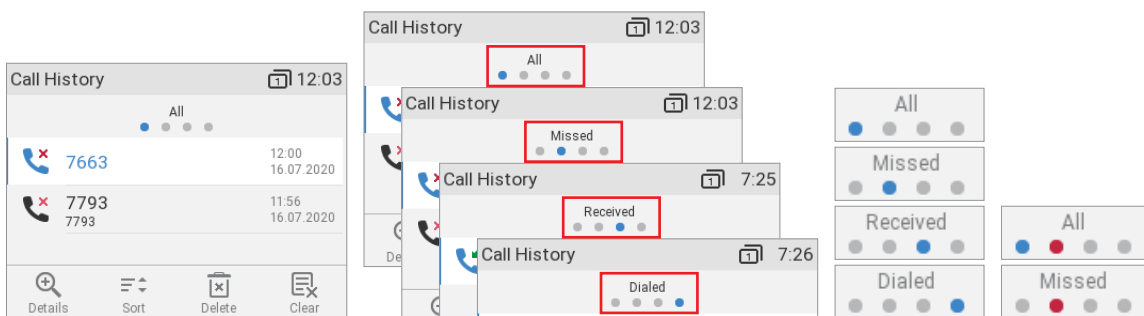



Fig. 1

Fig. 2



Fig. 3

Fig. 4



The red dot indicates the arrival of new missed messages since the last time the missed calls were viewed (Fig. 4). It is removed from the list of all calls and turns blue in the list of missed calls once the list has been viewed.

2. To view the list of missed, received, or dialed calls, press the left and right arrows   on the navigation key to put the lists on-screen one after the other (Fig. 2).







Note: On the idle screen you can also use the following keys to view the lists directly (default setting):

- Missed calls: Press the right arrow  on the navigation key. See also "Missed Calls" on page 62.
- Received calls: Press the left arrow  on the navigation key.
- Dialed calls: Press .

3. On each list, the latest call is at the top of the list (Fig. 1, above). Scroll through the list with the up/down arrows  on the navigation key. The icons indicate the type of call:

-  - missed call
-  - received call

 - dialed call

- Press  to dial the number of the selected call.
- Press  to delete the selected call.
- Press  to delete the entire list.
- Press  for three seconds to return to idle screen.
- Press  to sort the calls.
- Press  to show the call details of the selected call.

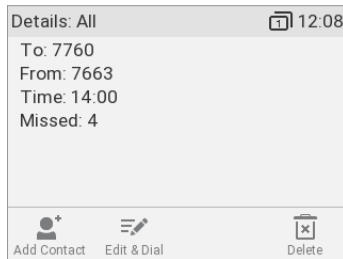

Fig. 1

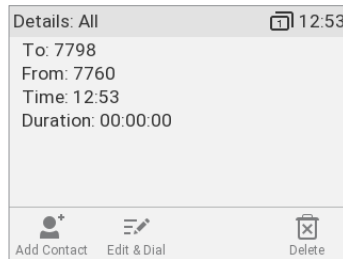



Fig. 2

- Missed calls: To, from, time (and date if not today), total number of missed calls from caller (Fig. 1).
- Received and dialed calls: To, from, time (and date if not today), duration of call (Fig. 2).
- When viewing the Details of a call:
 - Press  to add the caller/callee to the phone's directory. See "Editing existing entry" on page 42 for information on adding a name and other data to the new directory entry.
 - Press  to delete the call.

Locking and unlocking the keyboard

When the keyboard is locked, only the emergency numbers configured on the **Preferences** page of the phone's web user interface can be dialed.

Setting a PIN to unlock the keyboard (optional): See "Setting a PIN to unlock the keyboard" on page 101.

For more information on dialing and setting emergency numbers, see "Calling emergency numbers" on page 52 and "Emergency numbers" on page 94.

Locking

Press  for three seconds. The lock symbol appears in the status line.

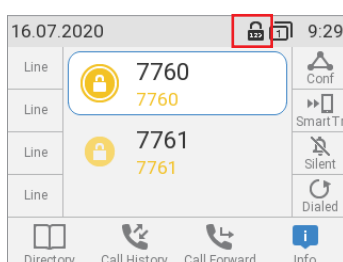

Unlocking

1. Press  for three seconds. You will be prompted to confirm that you want to unlock the keyboard.

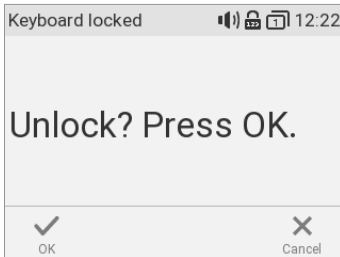

2. Press  to confirm.
3. If a PIN for unlocking the keyboard has been set, you will then be prompted to enter the PIN.

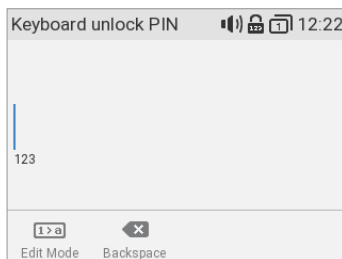



4. Confirm the PIN by pressing .

Rejecting or redirecting incoming calls

This includes manual and automatic rejection and redirection and rejection of anonymous calls.

Manually

If you do not wish to pick up a ringing call, you have three options: Letting the call ring and not picking it up, rejecting it manually, or transferring it manually to a third party.

- Rejecting a ringing call manually.
 - Press . The caller will hear the busy signal.
 - Press  for two seconds to reject the call and additionally place the caller on the "Deny" list of the phone's directory so that calls from that number do not ring on your phone; the caller hears the busy signal. For more information on the "Deny" list and how to edit or remove entries from it, see "Contact Types" on page 40.
- Transferring the ringing call to another phone (blind transfer). See "Blind transfer of ringing call" on page 62.

Automatically

There are four options for rejecting incoming calls automatically or to have them forwarded automatically, either always or under certain conditions:

- **Deny List.** Calls from phone numbers on this list will not ring on your phone; callers will hear the busy signal. For further information, see "Contact Types" on page 40.
- **DND - do not disturb mode.** All incoming calls are forwarded to the number set in call forwarding when busy; if there is no setting for call forwarding, callers hear the busy signal.

Exception: Phone numbers designated VIP in your phone's directory will ring on your phone even when DND is on.

Pressing  will activate and deactivate DND for all identities on the phone. You can activate and deactivate DND for selected identities on the respective identity page of the phone's web interface (administrator mode only). See "Preprogrammed, variably programmable function keys" on page 21 for more information.





- **Call forwarding.** See "Call forwarding" on page 66 and on page 95.
- **Rejecting anonymous calls:** See the following section.

Rejecting anonymous calls

With this setting you can have your phone reject calls from phones that are blocking or not transmitting their numbers.

Please **note:** Calls from analog phone connections without caller ID will, most likely, be received as anonymous calls. They will be rejected when you turn this function on.

Activating rejection of anonymous calls

1. Press .
2. Select **Call Features** and press .
3. Select **Incoming Calls** and press .
4. Select **Reject anonymous**. The default setting is off (**no**) (Fig. 1).
5. Press  to change the setting to on (**yes**) (Fig. 2).

Note: When the function is active, pressing  will turn it off.

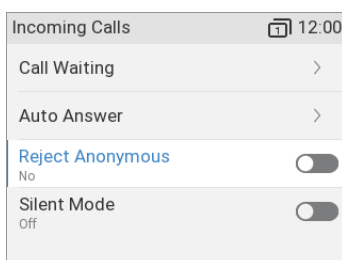

Fig. 1

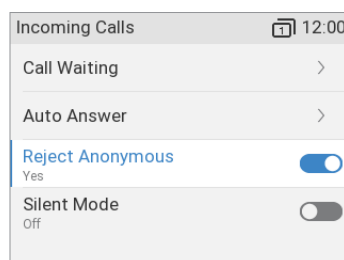

Fig. 2

6. Press  for two seconds to return to the idle screen.

Call forwarding

The phone can be set to forward incoming calls, either always or under certain conditions. The settings can be done on the phone and on the web interface. For further information on using the web

interface for these settings, see "Call forwarding" on page 95.

Note: Call forwarding is set separately for each configured identity. When the setting is done on the phone, it applies to the identity selected as outgoing identity.

Forward All: Forwarding all incoming calls to the number of the phone, extension, or mailbox specified as this function's target.

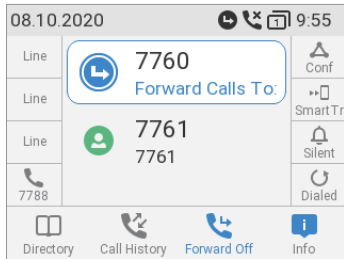

Fig. 1

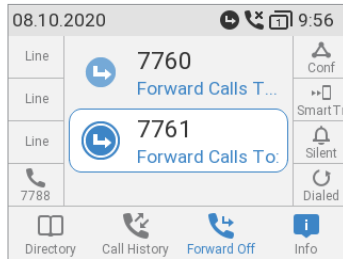



Fig. 2

Fig. 1: All calls for one of the configured identities are forwarded to a specified target.

Fig. 2: All calls for all or more than one of the configured identities are forwarded to a specified target or specified targets.

In the default setting, the symbol  is available in the function key line, and pressing the associated key turns forwarding of all calls on and off, respectively. You can also map the function onto another function key or use the settings menu as shown in the table below.

Forward when Busy: Forwarding calls ringing while the phone is busy to the number of the phone, extension, or mailbox specified as this function's target.

Forward after Timeout: When a call starts ringing, the phone will wait for the number of seconds specified in the setting "Call forwarding time". If the call is not accepted by the end of this time period, it is forwarded to the number of the phone, extension, or mailbox specified as this function's target.

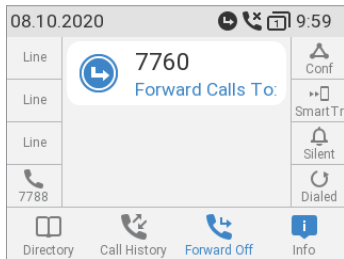

Fig. 3 – Forwarding all calls

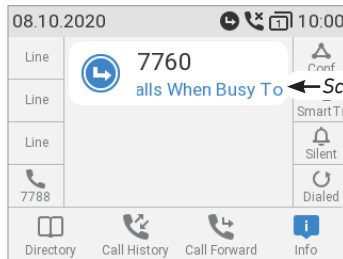

Fig. 4 – Forwarding when busy

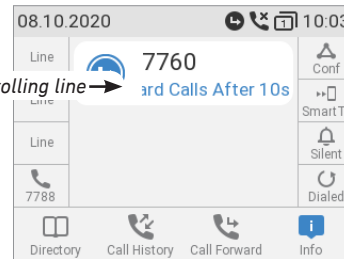























Fig. 5 – Forwarding when call has not been answered after time set in seconds

Settings on the phone and turning on call forwarding

	Forward all	Forward when busy	Forward after timeout
Press			
Press	 Call Features	 Call Features	 Call Features
Press	 Call Forwarding	 Call Forwarding	 Call Forwarding
Press	 Forward All	 Forward when Busy	 Forward after Timeout
Press	 or  Enable forwarding	 or  Enable forwarding	 or  Enable forwarding
	The setting changes from off (no) (Fig. 6, below) to on (yes), and the setting for the forwarding target appears (Fig. 7). In the case of forwarding after timeout, the setting for the time span also appears (Fig. 8).		
Press	 Target	 Target	 Target

Type	phone number	phone number	phone number
Press			Call Forwarding time
Type			number of seconds
Press	for two seconds to return to the idle screen.		

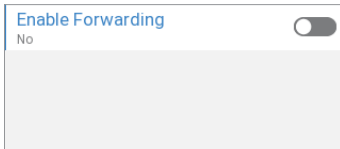

Fig. 6



Fig. 7

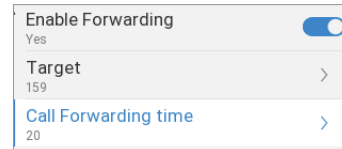

Fig. 8

Turning off call forwarding

	Forward all	Forward when busy	Forward after timeout
Press			
Press	Call Features	Call Features	Call Features
Press	Call Forwarding	Call Forwarding	Call Forwarding
Press	Forward All	Forward when Busy	Forward after Timeout
Press	or Enable forwarding	or Enable forwarding	or Enable forwarding
	The setting will change from on to off, and the settings for the forwarding target and, in the case of timeout, for the time span will disappear.		

Press for two seconds to return to the idle screen.

Turning forwarding of all calls on/off with a function key

Turning call forwarding on

Note: Call forwarding is set separately for each configured identity separately. When the setting is done on the phone, it applies to the identity selected as outgoing identity.

1. Press . The display will show the **Target when Forwarding** screen.

Note: If is not available when the display is in idle mode, you can make it available on the **Function Keys** page of the phone's web interface. For further information see chapter *Configuring the function keys*, "Example 4, Changing setting of context-sensitive key" on page 82. Default settings: See "At a glance" on page 18.

2. If no forwarding number has been set or if it needs to be changed, make the necessary entries.
3. Press .

Turning call forwarding off

Press the function key underneath .

Configuring the function keys

See page 35 on how to open the phone's web interface. See "How the web interface works" on page 36 on the mechanics of navigating in the windows and changing the settings.

Any changes you make will not take effect until you press **Apply** and **Save**. Changes will be lost if you open another page of the web interface without first pressing **Apply/Save**.

Function keys on Snom phones

Every phone has a limited number of hard keys. Phone users, however, have a myriad of different priorities and preferences when asked which functions they use most often and which functionalities they would like to access quickly. Snom has therefore designed the function keys to be programmable, even the preprogrammed "hard keys" whose default function is printed on them.

There are four types of programmable function keys (see also "At a glance" on page 18):

- Context-sensitive, programmable function keys. For the default settings, see "At a glance" on page 18. You can select a different key event to be available on each respective key when the phone is in idle mode.

You cannot change the functions that are available when the phone is active, for example when you are in a call, when the phone is ringing, etc. Depending on the activity, different functions will be available.

See "Appendix 1 - Display Symbols and Icons" on page 107 for the lists of symbols and their description.

- Navigation, confirmation, and cancel keys. For the default settings, see "At a glance" on page 18. You can select a different key event to be available on each respective key when the phone is in idle mode.

You cannot change the functions that are available when the phone is active, for example when you are in a call, when the phone is ringing, etc.

- Dedicated, customizable function keys. The default setting is the respective key event printed onto the key. Other key events and a selected number of other functionalities can be programmed onto them.

- Freely programmable function keys on the phone and on connected expansion modules. All available functionalities, including key events, can be programmed onto them.

When an expansion module is connected to the phone, its function keys are added to the **Function Keys** page of the web user interface of the phone (see "Function key page of phone's web interface" on page 71, Fig. 4 and 5).

Note: For information on connecting the D3 expansion module, please refer to the user manual at <https://service.snom.com>, **Accessories** button, **Expansion Modules**. The user manual also contains specific information on the D3's configuration.

The settings of the function keys on the expansion modules are stored on the phone and, unless deleted prior to the module's disconnection, remain available to be used when the same or any

other module of the same type is connected to the phone. They are not visible on the function keys page when no expansion module is connected.

- **Context**

This setting specifies which configured identity will be used when executing the functionality of the key. You may want to use this feature when you have accounts with different providers or when you wish to present different identities to certain destinations.

For example: If you have programmed key P2 to speed dial a specific number and you want to use configured identity 2 to call that number, select configured identity 2 from the drop-down menu of P2's "Context". When you speed dial the number by pressing key P2, identity 2 will be used as the outgoing identity.

The default setting is "Active", which means that the identity selected as the phone's outgoing identity at any given time will be used.

- **Type**



Select the type of functionality from the drop-down list. See "Appendix 4 - Programmable Functions" on page 117 for more information. If you select "Key Event", a drop-down list with the available key events will replace the text field under "Number". The default setting is "line".

- **Number**

Enter one phone number or value for the function or, if the function is key event, select an event from the drop-down list. Enter phone numbers exactly the way they need to be dialed, i.e, type the number without spaces or punctuation marks between the digits. For example, a number with an area code that might conventionally be notated as (916) 555-1234 should be entered as 9165551234.

- **Short/Full Label Mode (phone)**



Select a mode from the drop-down list. The default settings for both are icon and text.

- Icon. The label will display the icon of the functionality mapped onto the key, e.g., , if extension; , if speed dial; etc.
- Text. The label will display the text you have entered in step 10 of "Function key settings on the phone" on page 73 or the number if no text was entered.
- Icon and text. The label will display the icon of the functionality mapped onto the key and the text or number.

- **Short/Full Label (phone), Label (D3 expansion module)**

Optional: Enter a name or other descriptive text in the text field. This is the data displayed on the key's label area on the phone and on the D3's display, respectively. If you leave the field blank, the number will be displayed in the key label area.

- **LP Feature (setting on phone only – functionality for long-pressing of keys)**

This is a shortcut to the configuration menu of each function key with LED   (keys P1–P32). In the default setting, the function is enabled (Fig. 1).

If necessary, use the page key  to select the page the key is on and press the key for three seconds to open its configuration menu. The yellow LED on the key blinks. See "Function key settings on the phone" on page 73, step 4, on how to continue.

Note: The LP Feature must be deactivated for the functions Push2Talk and Line Info Layer.

If the LP feature of a key has been disabled, use the **Preferences** menu, **Fkeys** and **SmartKeys** submenus to access the key's configuration menu.

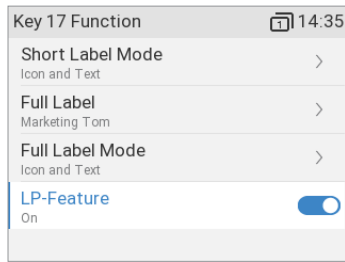

Fig. 1

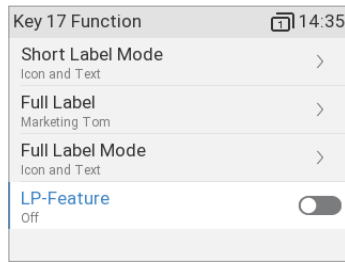

Fig. 2

Function key page of phone's web interface

The page has two subpages. The key settings are configured on the subpage **Key Assignment**; the manner in which the SmartLabel keys are shown on the display is configured on the subpage **SmartLabel**.

Key Assignment SmartLabel

SmartLabel Keys:

Page Page 1

	Context	Type	Number	Short Label Mode	Full Label Mode	Short Label	Full Label	XML Label
P1	Active	Line		Icon and Text	Icon and Text			
P2	Active	Line		Icon and Text	Icon and Text			
P3	Active	Line		Icon and Text	Icon and Text			
P4	Active	Line		Icon and Text	Icon and Text			
	Active	Key Event	Conference	Icon and Text	Icon and Text			P5
	Active	Smart Transfer		Icon and Text	Icon and Text	SmartTr	SmartTransfer	P6
	Active	Key Event	Ringer Silent	Icon and Text	Icon and Text			P7
	Active	Key Event	Redial	Icon and Text	Icon and Text			P8

Fig. 1 - Page 1 with keys P1–P8 on phone's web interface

Page Page 2

	Context	Type	Number	Short Label Mode	Full Label Mode	Short Label	Full Label	XML Label
P9	Active	Extension	< sip:7793@example	Text	Text	Tom	Tom Waterhouse	
P10	Active	Extension	< sip:7793@example	Icon	Icon and Text	Tom	Tom	
P11	Active	Extension	< sip:7793@example	Icon and Text	Icon and Text	Tom	Tom Waterhouse	
P12	Active	Extension	< sip:7793@example	Icon and Text	Icon and Text			
	Active	Speed Dial	9175550123	Text	Text	Mary	Mary Pickford	P13
	Active	Speed Dial	9175550123	Icon	Icon and Text	Mary		P14
	Active	Speed Dial	9175550123	Icon and Text	Icon and Text	Mary	Mary Pickford	P15
	Active	Speed Dial	9175550123	Icon and Text	Icon and Text			P16

Fig. 2 - Page 2 keys with and without "Short" and "Full Label" settings

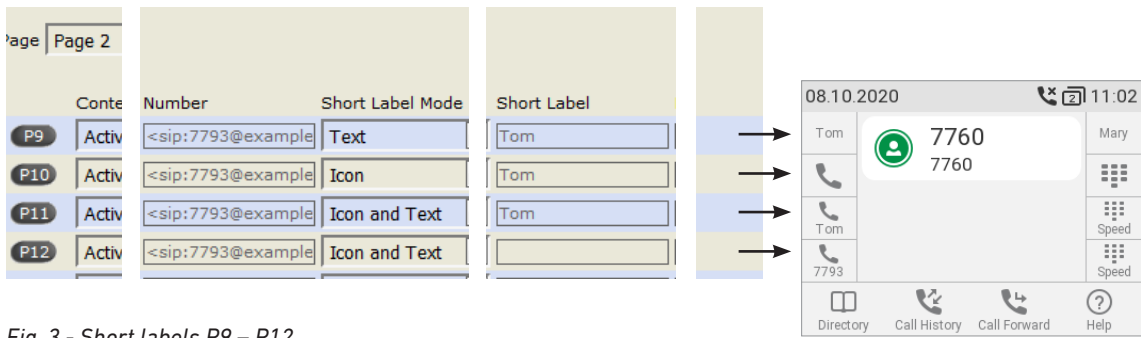

Fig. 3 - Short labels P9 – P12

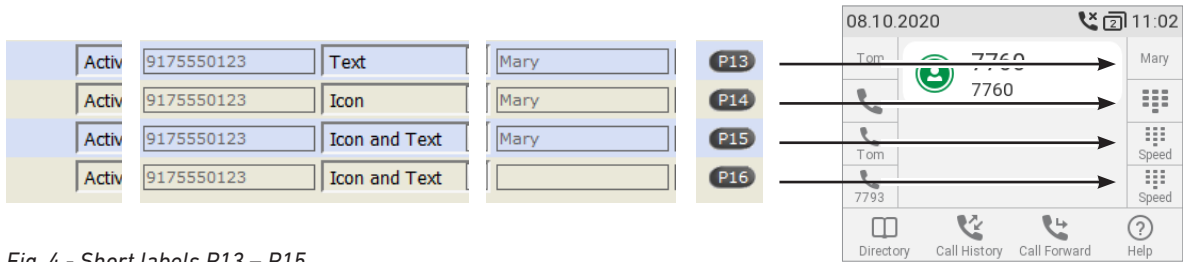

Fig. 4 - Short labels P13 – P15

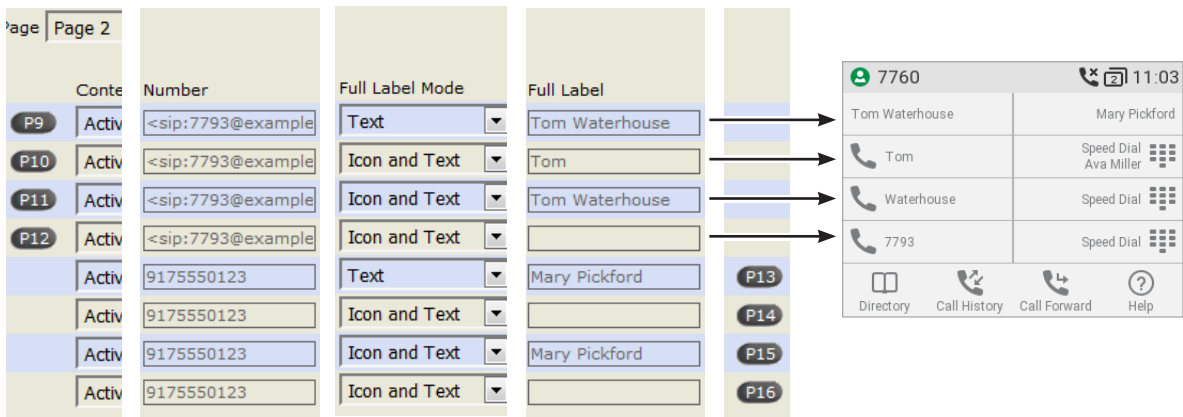

Fig. 5 - Full Labels P9 – P12

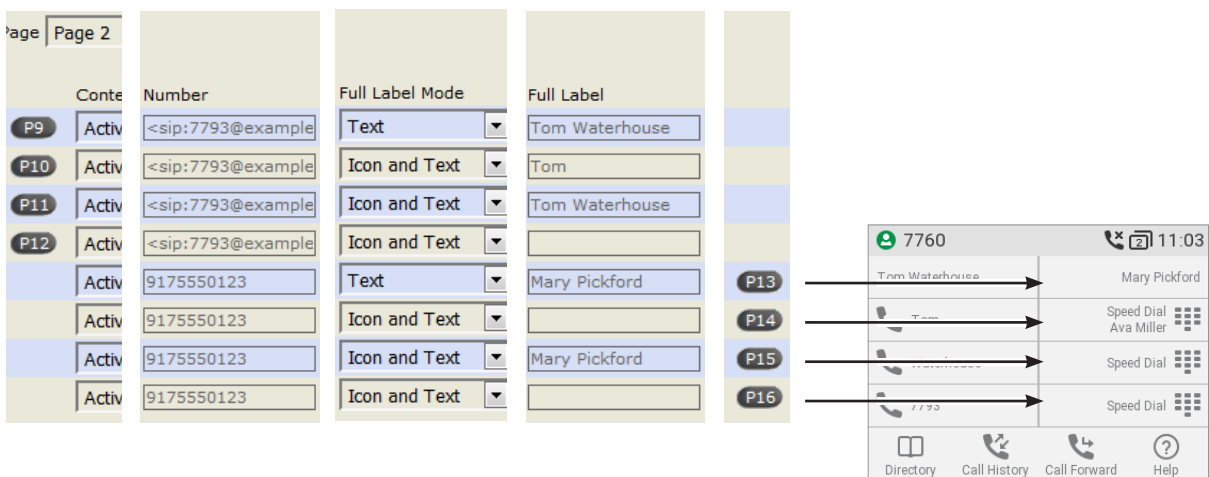

Fig. 6 - Full Labels P13 – P16

When expansion modules are connected to the phone, they will also be shown on the function key page of the phone's web interface, below the phone's function keys and above the **Apply** button. Their settings are stored on the phone, not on the expansion module. For more information, see "Example 2, Extension monitoring and call pick-up on D3 expansion module" on page 79 and the D3 user manual available at <https://service.snom.com>, **Accessories** button, **Expansion Modules**.

Context	Active	Type	Number	Short Text	XML Label	
1	Active	Extension	<sip:159@example.snom.c	Sales		
	Active	Extension	<sip:180@example.snom.c	Accounting	10	
2	Active	Extension	<sip:160@example.snom.c	Sales		
	Active	Extension	<sip:160@example.snom.c		11	

Fig. 7 - Function keys of connected D7 expansion module

Programming the function keys

The freely programmable function keys on the phone and on all connected expansion modules can be mapped on the phone and on the phone's web interface. We recommend using the web interface which is faster and more comfortable.

Function key settings on the phone

On the phone, a limited number of functionalities is available.

1. Press > > **Preferences** > **Fkeys** (Fig. 2).

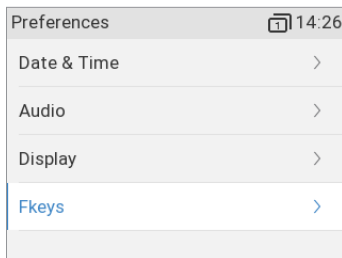

Fig. 1

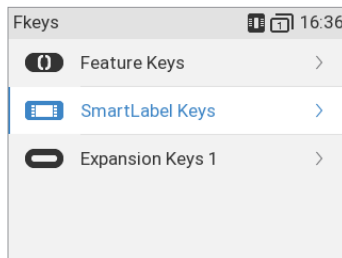

Fig. 2

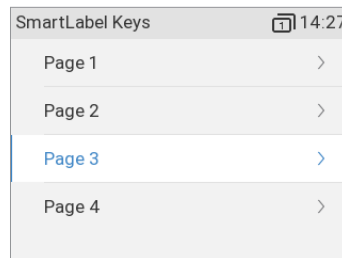

Fig. 3

2. Select **SmartLabel Keys**.
3. Select **Page 1, 2, 3, or 4**, respectively, by scrolling to the respective page and pressing (Fig. 3). In the following example, we will be configuring key 17 on page 3.



Fig. 4



Fig. 5

4. Select a key and press to open the **Key 17 Function** menu (Fig. 4). The selected key flashes yellow if the SmartLabel key page with the key to be configured is on-screen (Fig. 5 – press to page).

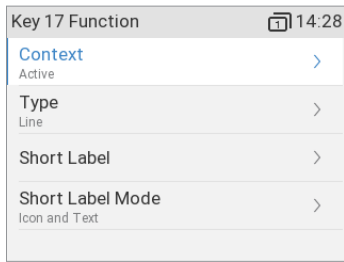

Fig. 6

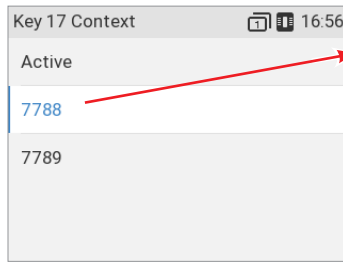

Fig. 7

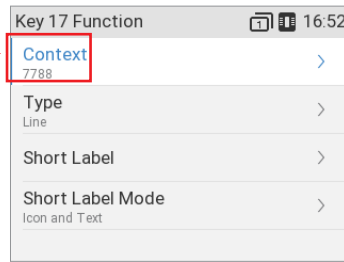

Fig. 8

5. The default for **Context** is *Active*, i.e., all configured identities whose status is "active" (Fig. 6).
 - a. If you want to restrict the functionality to a configured identity, select **Context** and press .
 - b. Select the identity from the menu (Fig. 7) and press . The following prompts depend on the selected functionality.
6. Select **Type** and press (Fig. 9). Use / to scroll to a functionality on the list (Fig. 10) and press . The information you will then be prompted to enter depends on the selected functionality.

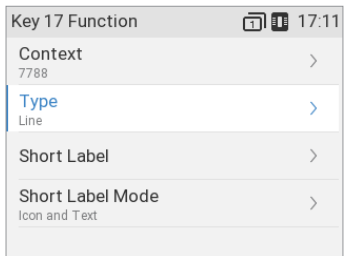

Fig. 9

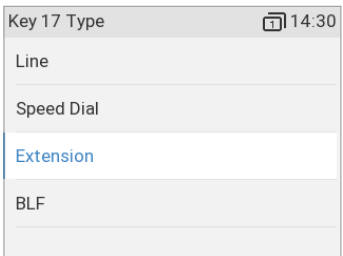

Fig. 10

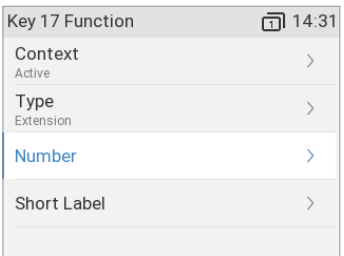

Fig. 11

7. In our example, the functionality is *Extension* (Fig. 8). Press to select and return to the Key 17 function menu where **Number** has been added to the menu below "Type" (Fig. 11).
8. Select **Number** and press .
9. Enter the extension number and press (Fig. 12).

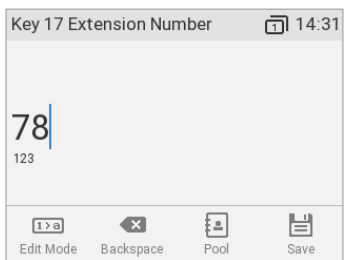

Fig. 12

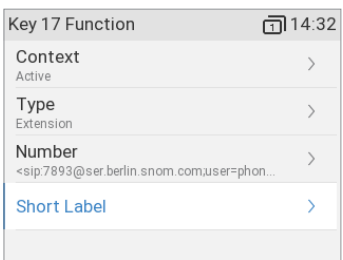

Fig. 13

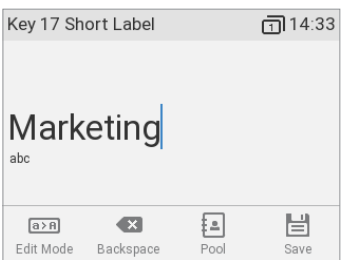

Fig. 14

10. **Short Label** (Fig. 13) and **Full Label** on the phone, and **Label** on the D3, are optional. This is the data displayed on the key's label area on the phone's function key screen and on the D3's display, respectively (see "Function key page of phone's web interface" on page 71, figure 3–7). If you do not enter data for each label type, the number will be displayed in the label area instead. Enter a name or other descriptive text (Fig. 14) and press , or press without entering data.

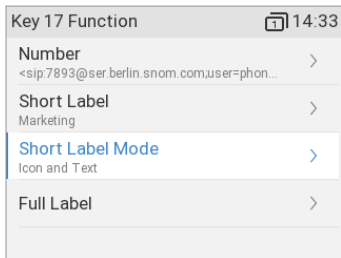

Fig. 15

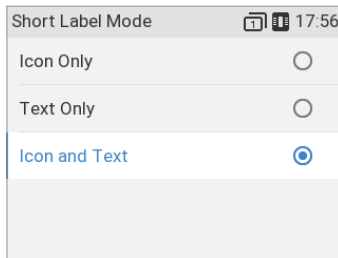

Fig. 16

11. Select **Short Label Mode** (Fig. 15) and press .
12. Specify the content you want the label to display by scrolling to the respective line (Fig. 16) and pressing to save and return to the **Key 17 Function** menu (Fig. 15). The default is icon and text; you can also select text or icon only — see "Short/Full Label Mode (phone)" on page 70 for more information.
13. Select **Full Label Mode** and press .
14. Specify the content you want the label to display by scrolling to the respective line and pressing to save and return to the **Key 17 Function** menu. The default is icon and text; you can also select text or icon only — see "Short/Full Label Mode (phone)" on page 70.
15. Press briefly to return to the **Key Function** menu; press for 3 seconds to return to the idle screen. When page 3 is on-screen, the top left key can now be used to dial the extension by briefly pressing the key and to pick up calls ringing on the extension; the LED will indicate the call status of the extension, i.e., idle, ringing, and in call. See "Example 1, Extension monitoring and call pick-up" on page 77 for more information on how to configure and use extension monitoring.

Function key settings on the web interface

See "Selected examples for function key programming", below, for the function key mapping and "Display options for SmartLabel keys" on page 83 for the optical presentation on the display.

Key Assignment
SmartLabel

SmartLabel Keys:

Page Page 1

Context	Type	Number	Short Label Mode	Full Label Mode	Short Label	Full Label	XML Label
P1	Active	Line	Icon and Text	Icon and Text			
P2	Active	Line	Icon and Text	Icon and Text			
P3	Active	Line	Icon and Text	Icon and Text			
P4	Active	Line	Icon and Text	Icon and Text			
	Active	Key Event	Conference	Icon and Text	Icon and Text		
	Active	Smart Transfer		Icon and Text	SmartTr	SmartTransfer	
	Active	Key Event	Ringer Silent	Icon and Text	Icon and Text		
	Active	Key Event	Redial	Icon and Text	Icon and Text		

Context-Sensitive Keys:

Type	Number	Label
Key Event	Directory	
Key Event	Call Lists	
Key Event	Forward all	
Key Event	Help	

Fig. 1

The screenshot shows the 'SmartLabel' configuration page. It has two tabs: 'Key Assignment' and 'SmartLabel', with the latter selected. The page is organized into four sections:

- Idle Screen:**
 - Default Display Mode: Short
 - Alternative Display Mode: Full
 - Alternative Display Trigger: Proximity Sensor
- Call Screens:**
 - Default Display Mode: Short
 - Alternative Display Mode: Full
 - Alternative Display Trigger: Proximity Sensor
- Other Screens:**
 - Alternative Display Trigger: Short Press Page Key
- Options:**
 - Reset to default display mode after (sec.): 3
 - Return to Label Page 1 after (s): 0

An 'Apply' button is located at the bottom left of the configuration area.

Fig. 2

1. On the phone's web interface, click on **Function Keys** in the menu on the left. When the page is opened, the **Key Assignment** page is on-screen, as indicated by the **bold** font of its tab (Fig. 1). The four types of programmable function keys can be configured on this page.
2. Click the **SmartLabel** tab to open the settings for the appearance of the SmartLabels on the display (Fig 2). For the instructions on these settings, see "Display options for SmartLabel keys" on page 83.
3. If you make any modifications to the settings on either page, click **Apply** to save them before opening the other subpage or any other page of the phone's web interface, and before closing the web interface.
4. After you have clicked **Apply**, the button **Save** will appear at the top of the page. We strongly recommend clicking this button as well; any modifications not saved will be lost if and when the phone is unplugged from its power source or when there is a power outage.

Selected examples for function key programming

This chapter will show you a few examples for customizing function key settings to your needs and preferences, using the phone's web interface:

- First example: Extension monitoring and call pickup via one of the phone's freely programmable and self-labeling function keys with LED
- Second example: Extension monitoring and call pickup via a function key on the D3 expansion module
- Third example: Speed dialing with a freely programmable function key with LED
- Fourth example: Changing setting of context-sensitive key

Example 1, Extension monitoring and call pick-up

This feature makes it possible to pick up a call ringing on another extension registered at the same registrar, for example when the other extension is busy or when the user is absent. The prerequisites for this function are:

- It must be supported by the PBX.
- The extensions must permit this function. Setting: Phone's web interface > **Configuration Identity** (1-12) > **SIP** tab > "Allow incoming extension monitoring". The default is **on**.
- Restricting permission to groups of users by setting an ID: Phone's web interface > **Configuration Identity** (1-12) > **SIP** tab > "Extension monitoring group ID": Enter an ID (any character string) into the textfield. Note: The first character of the ID must not be a '{' curly brace.
- The extension to be monitored must be programmed onto one of the freely programmable function keys with LEDs. In our example we are monitoring extension 7793 on key P9 of page 2.

SmartLabel Keys:

Page

	Context	Type	Number	Short Label Mode	Full Label Mode	Short Label	Full Label
P9	Active	Extension	<sip:7793@example	Text	Text	Tom	Tom Waterhouse
P10	Active	Extension	<sip:7793@example	Icon	Icon and Text	Tom	Tom

1. On the phone's web interface, click on **Function Keys** in the menu on the left.
2. Click the **Key Assignment** tab, if necessary.
3. Select **Page 2** from the drop-down menu of **Page**.
4. Under **Context** of P9, select "Active" or one of the configured identities from the drop-down list.
5. Under **Type**, select "Extension" from the drop-down list.
6. In the **Number** text field, enter the phone number whose calls you want to pick up. In our example it is 7793.
7. Select a display option from the drop-down menu of **Short Label Mode**. The default is "Icon and text", i.e., an icon depicting the function on the key and the number or the short label text will be displayed on the display. name or descriptive text.
8. Select a display option from the drop-down menu of **Full Label Mode**. The default is "Icon and text", i.e., an icon depicting the function on the key and the number or the short label text will be displayed on the display.
9. Optional: In the text fields of **Short Label** and **Full Label**, enter a name or descriptive text. In our example, it is "Tom" and "Tom Waterhouse", respectively. If either one or both of the text fields are empty, the label area will display the number.
10. Click on **Apply** and **Save**.

Note: The page with the monitored extension(s) must be on-screen in order for the key's LEDs to show the status of the respective monitored extension.

The LED of key P9 on the phone will now flash red quickly when a call is ringing on 7793 but **only when page 2 is on-screen**. If the call is not answered, you can pick it up by pressing key P9. When 7793 is engaged in a call – **and page 2 is on-screen** – the key will glow red steadily.

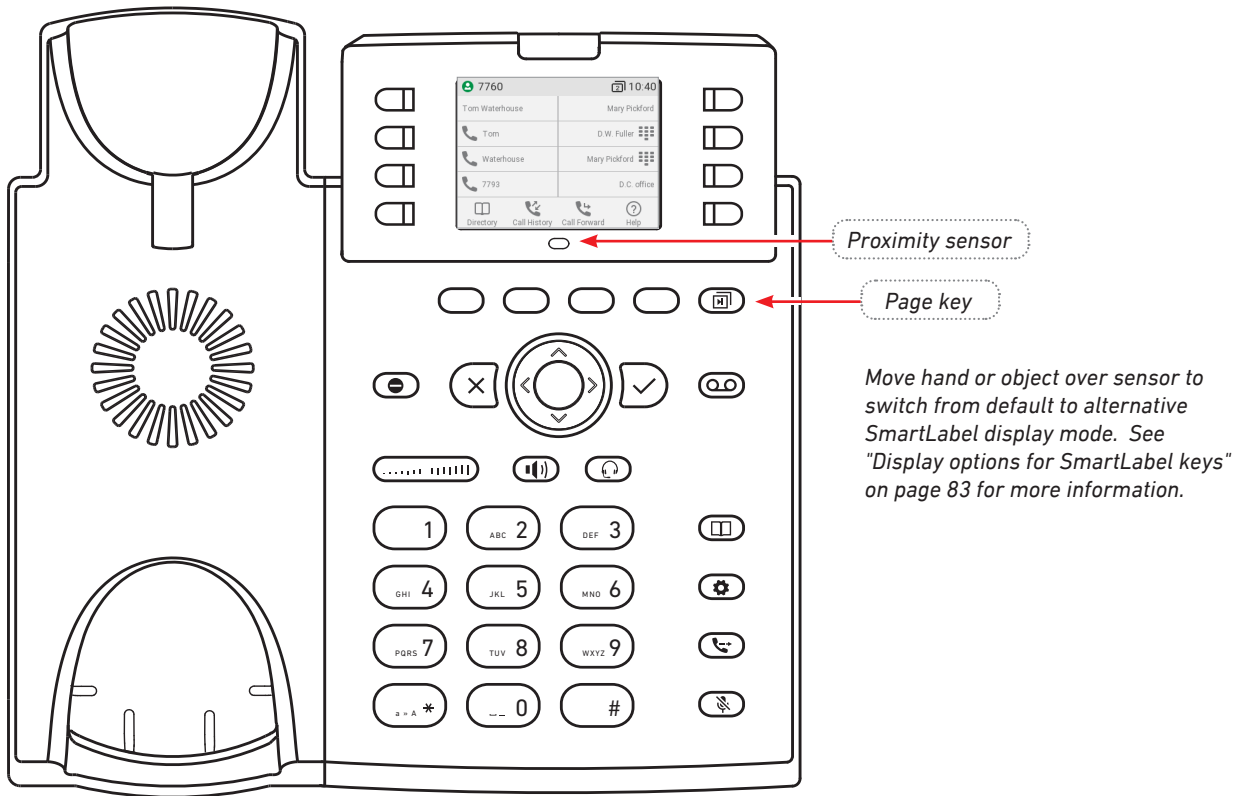

Fig. 1

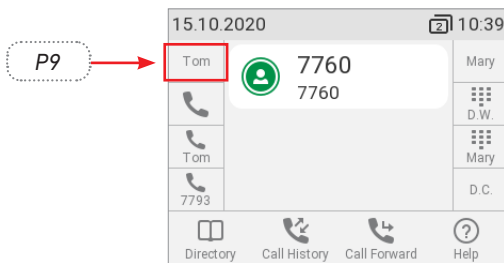

Fig. 2 – Short label mode

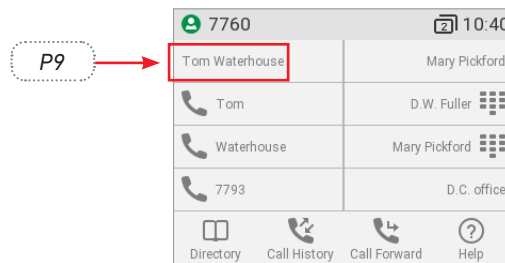

Fig. 3 – Full label mode

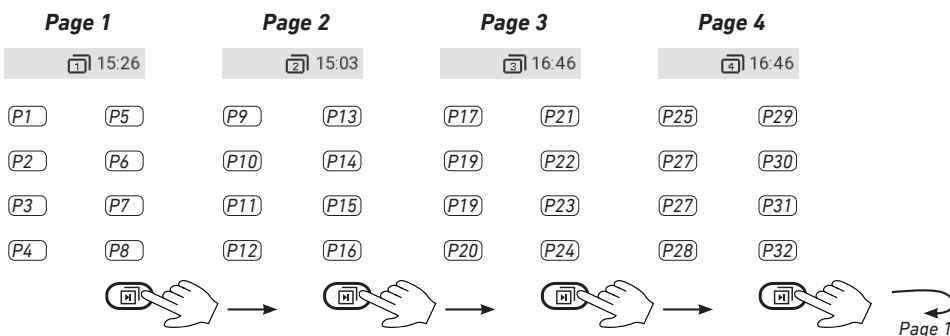
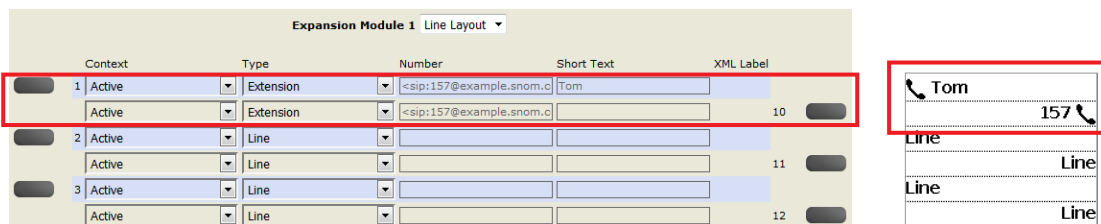

Fig. 4

Press key to put page 2, 3, and 4 on-screen successively. When page 4 is on-screen, press key to return to page 1.

Example 2, Extension monitoring and call pick-up on D3 expansion module

- All functions available on the freely programmable LED function keys of the phone are available on the connected D3.
- The prerequisites are the same as those for the LED function keys on the phone. See "Example 1, Extension monitoring and call pick-up" on page 77.
- For information on how to connect the D3 to the phone, as well as on D3 function key and display layout and settings, please see the D3 User Manual at <https://service.snom.com>, **Accessories** button, **Expansion Modules**.



- On the phone's web interface, click **Function Keys** in the menu on the left.
- Click the **Key Assignment** tab, if necessary.
- Scroll down to **Expansion Keys** and the expansion module you want to configure.
- Under **Context** of the key on the expansion module, select "Active" or one of the configured identities from the drop-down list.
- Under **Type**, select "Extension" from the drop-down list.
- In the **Number** text field, enter the phone number whose calls you want to pick up. In our example it is extension 157 on key 1 and extension 167 on key 10 (the left and right top keys on the D3).
- Optional: In the **Short Text** text field, enter a name or descriptive text. If you leave the field blank, the number will be displayed in the key's label area on the D3's display.
- Click **Apply** and **Save**.

The LED of the key on the D3 will now flash red quickly when a call is ringing on the extension. If the call is not answered, you can pick it up by pressing the key. When the extension is engaged in a call, the key will glow red steadily.

Example 3, Speed dialing

Besides using the **Speed Dial** page on the web interface to program speed dial numbers, you can also put the functionality on the freely programmable function keys with LEDs on the phone or a connected expansion module. In our example, key P15 on page 2 of the function keys will be used to speed dial the number 9175550123.

Context	Type	Number	Short Label Mode	Full Label Mode	Short Label	Full Label	XML Label
P9	Active	Extension	< sip:7793@example	Text	Text	Tom	Tom Waterhouse
P10	Active	Extension	< sip:7793@example	Icon	Icon and Text	Tom	Tom
P11	Active	Extension	< sip:7793@example	Icon and Text	Icon and Text	Tom	Tom Waterhouse
P12	Active	Extension	< sip:7793@example	Icon and Text	Icon and Text		
	Active	Speed Dial	9175550123	Text	Text	Mary	Mary Pickford
	Active	Speed Dial	9175550123	Icon	Icon and Text	Mary	
	Active	Speed Dial	9175550123	Icon and Text	Icon and Text	Mary	Mary Pickford
	Active	Speed Dial	9175550123	Icon and Text	Icon and Text		

1. On the phone's web interface, click on **Function Keys** in the menu on the left.
2. Click the **Key Assignment** tab, if necessary.
3. Select **Page 2** from the drop-down menu of **Page**.
4. Under **Context** of P15, select "Active" or one of the configured identities from the drop-down list.
5. Under **Type** of P15, select "Speed Dial" from the drop-down list.
6. In the **Number** text field, enter the phone number that you want to be able to speed dial. In our example it is phone number 555-0123 in area code 917.
Type each phone number with any necessary area code and/or country code etc. without spaces, hyphens, etc. Example: In conventional notation you might write the number as (917) 555-0123. Type 9175550123 into the text field.
7. Select a display option from the drop-down menu of **Short Label Mode**. The default is "Icon and text", i.e., an icon depicting the function on the key and the number or the short label text will be displayed on the display. name or descriptive text.
8. Select a display option from the drop-down menu of **Full Label Mode**. The default is "Icon and text", i.e., an icon depicting the function on the key and the number or the short label text will be displayed on the display.
9. Optional: In the text fields of **Short Label** and **Full Label**, enter a name or descriptive text. In our example, it is "Mary" and "Mary Pickford", respectively. If either one or both of the text fields are empty, the label area will display the number.
10. Click on **Apply** and **Save**.

You can now speed dial the number 9175550123 by selecting page 2 of the SmartLabels and pressing key P15 on the phone.

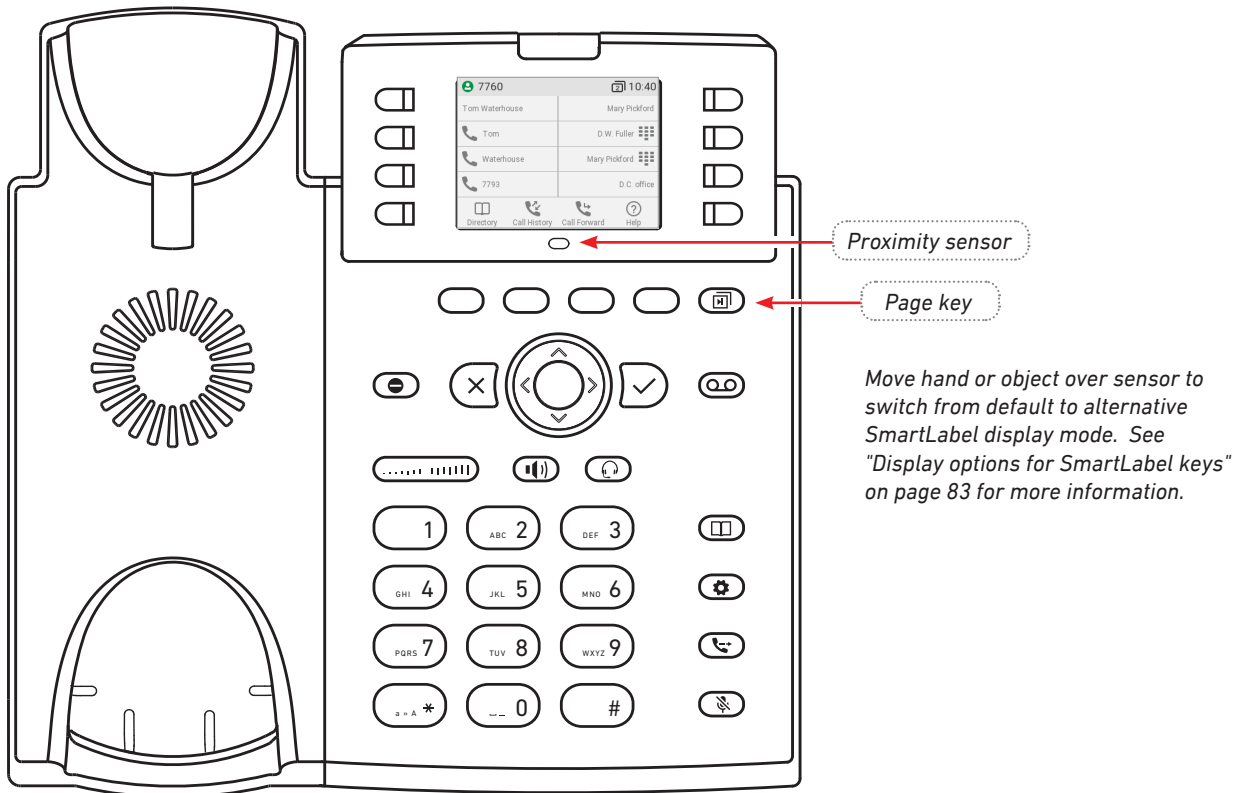

Fig. 1

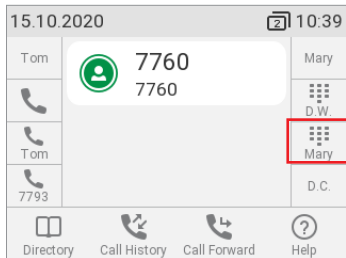

Fig. 2 – Short label mode

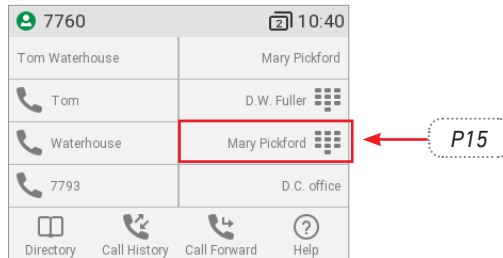

Fig. 3 – Full label mode

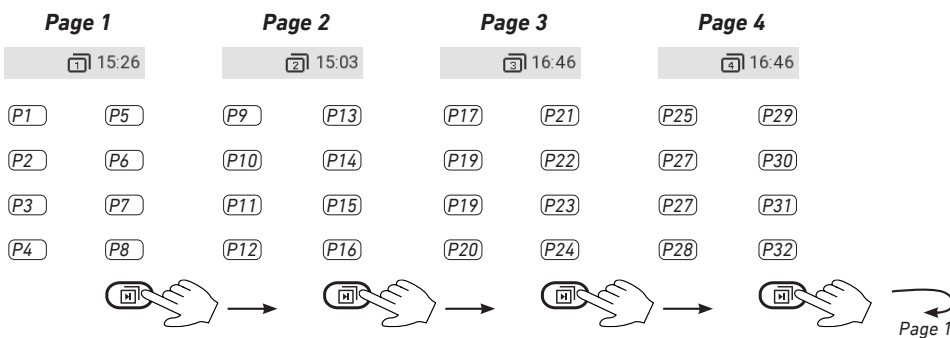
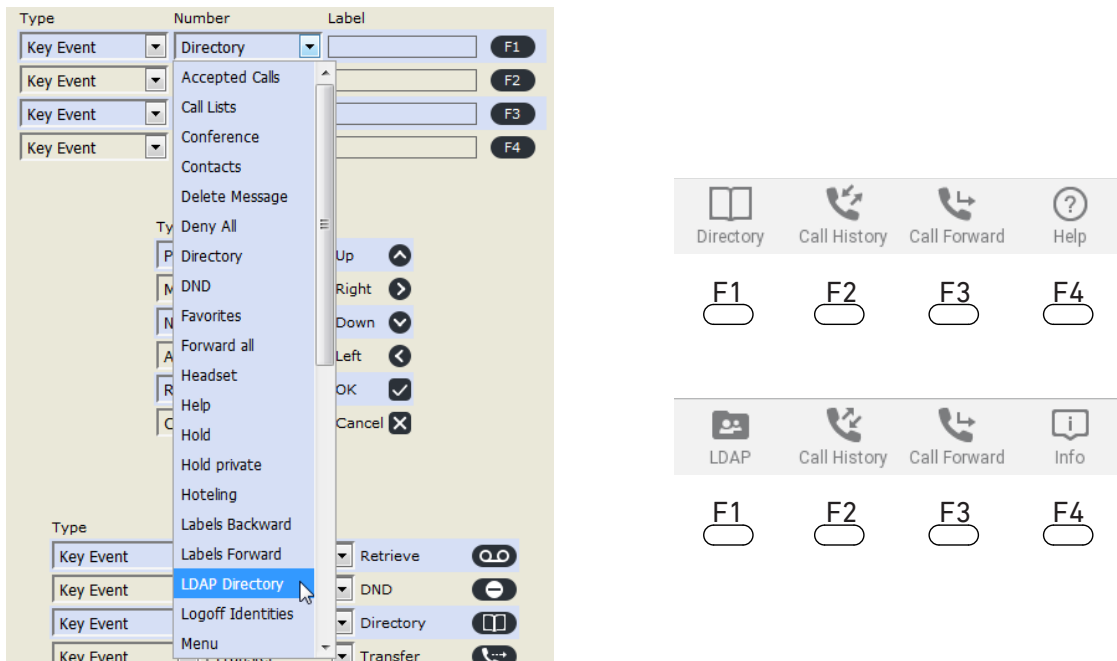

Fig. 4

Press to put page 2, 3, and 4 on-screen successively. When page 4 is on-screen, press to return to page 1.

Example 4, Changing setting of context-sensitive key

You can select a different key event to be available on the four keys under the display when the phone is in idle mode. You cannot change the functions that are available when the phone is active, for example when you are in a call, when the phone is ringing, etc. In the following example, the setting of the left key will be changed from **Directory** to **LDAP Directory**.



1. On the phone's web interface, click on **Function Keys** in the menu on the left.
2. Click the **Key Assignment** tab, if necessary.
3. Click the drop-down list of context-sensitive key F1 and select "LDAP Directory".
4. Click on **Apply** and **Save**.

By pressing key F1 you now have direct access to your LDAP directory, if available and if the settings are provided on the phone's **Advanced Settings** page > **Network** tab > **LDAP** section.

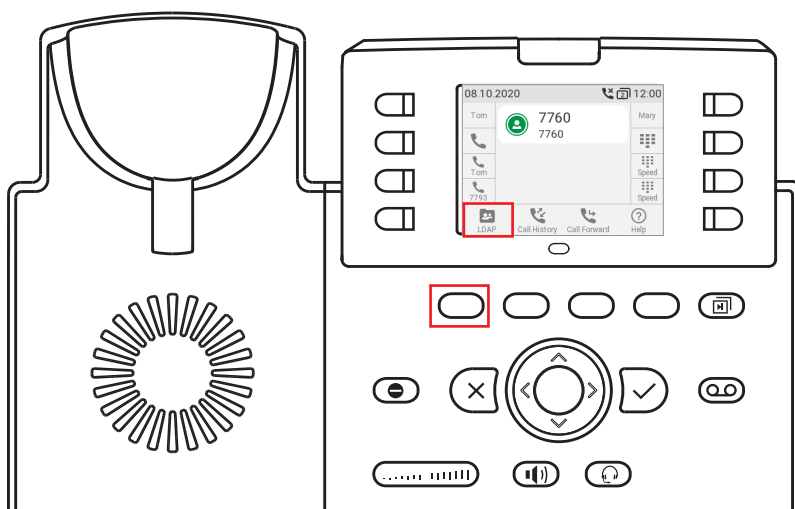

Display options for SmartLabel keys

A number of settings control the appearance of the SmartLabels on the display; they can be set on the phone and on the phone's web interface. There are separate settings for the idle screen, call screens, and other screens. Settings options:

- **Default display mode** and **Alternative display mode**. The display will revert to the default mode after the number of seconds set in **Back to default display mode** have elapsed. The factory defaults are **Short** label for the **Default display mode**, and **Full** label for the **Alternative display mode**. You can also turn either one or both of them off.

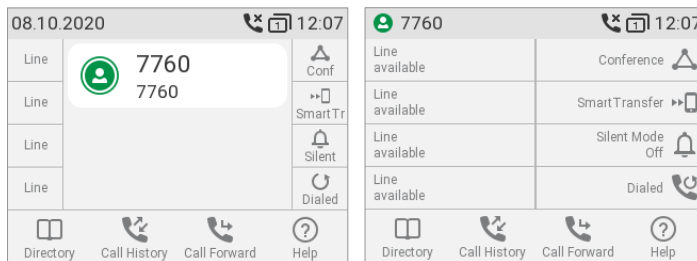

Short label

Full label

- **Alternative display trigger**. This setting defines how the appearance of the Smart Labels is switched from the default to the alternative appearance. The default setting is **Proximity sensor**; moving your hand or an object across the sensor (see "At a glance" on page 18) triggers the switch.
- **Return/Reset to default mode timer after (sec.)**. This setting defines after how many seconds the appearance of the SmartLabels will automatically return to the default. Valid values are 0 to 360 seconds, the default is 3 seconds. Selecting 0 turns automatic reversion off.
Manually returning the display mode to the default: Press . The display mode will also return to the default setting when another key is pressed, e.g., a number key to open the dial screen, the directory key to access the phonebook, etc.
- **Return to label page 1 after (sec)/Return to first page**. This setting defines after how many seconds the key page shown on the display, if other than 1, will automatically return to the first page. Valid values are 0 to 1209600 seconds; the default is 0 (firmware version 10.x).

Settings on the phone

Display mode settings

1. Press -> **Preferences**.
2. Select **Display** and press .
3. If any expansion modules are connected to the phone, use / to select **Primary display** and press .
4. Use the navigation key / to select **SmartLabel options** and press .

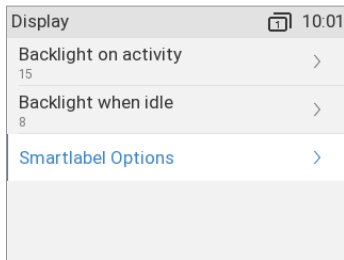

Fig. 1

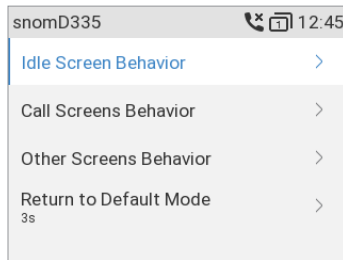

Fig. 2

5. Select **Idle Screen Behavior**, **Call Screen Behavior**, or **Other Screen Behavior** and press . The default settings are indicated in **bold italic** in the table. The available options for the three different screens are:

	Idle screen	Call screens	Other screens
Default display mode	Off	Off	-
	<i>Short</i>	<i>Short</i>	-
	Full	-	-
Alternative display mode	Short	Short	-
	<i>Full</i>	<i>Full</i>	-
Alternative mode trigger	Off	Off	<i>Off</i>
	Short-press	Short-press	Short-press
	Long-press	Long-press	Long-press
	<i>Proximity sensor</i>	<i>Proximity sensor</i>	

6. The configuration of the settings for all screens and other screens is done the same way.
 - Default and alternative display mode.
 - a. Select the display mode you want to change, for example the default mode (Fig. 3), and press . In the following example, the default mode is set to **Full** (Fig. 3 and 4), and we want to change it to **Short**.

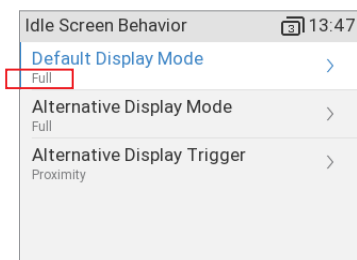

Fig. 3

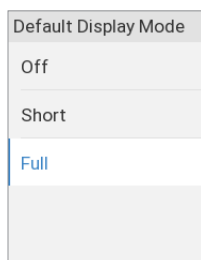

Fig. 4

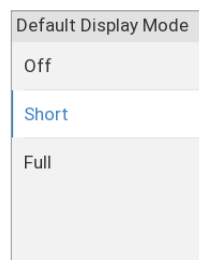

Fig. 5

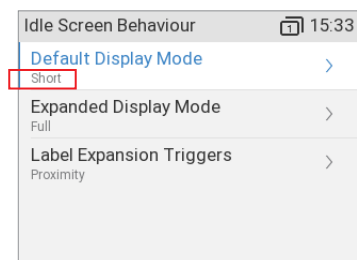

Fig. 6

- b. Use the navigation key / to select **Short** (Fig. 5) and press to save and return to the **Screen Behavior** menu where the line underneath **Default display mode** now reads **Short** (Fig.6).
 - Alternative mode trigger.
 - a. Use the navigation key / to select **Alternative display trigger** (Fig. 7) and press . In the following example, the trigger is currently set to **Long-press** (Fig. 7), as indicated by the radio button (Fig. 8), and we want to change it to **Proximity sensor**.

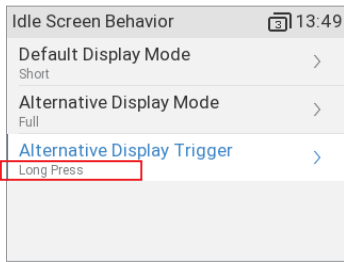

Fig. 7

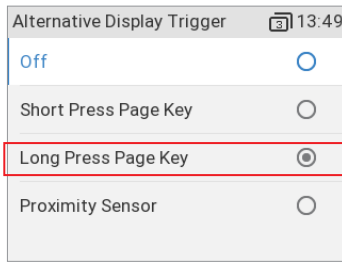

Fig. 8

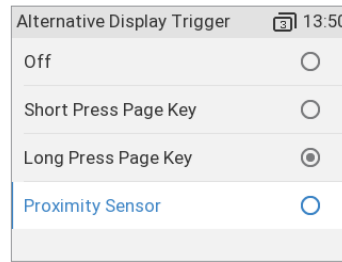

Fig. 9

- b. Use the navigation key ∇ / \blacktriangle to select **Proximity sensor** (Fig. 9).
- c. Press D to save and return to the **Screen Behavior** menu where the line underneath **Alternative display trigger** now reads **Proximity** (Fig. 10).

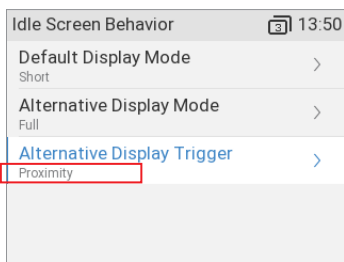

Fig. 10

7. Press X to return to the **SmartLabel options** menu (Fig. 2).

Timer setting for returning display mode to default

1. Press G -> **Preferences** -> **Display** -> **Primary display** (if there is at least one connected expansion module) -> **SmartLabel options**.
2. Select the **Return to default mode timer** (Fig. 11) and press D . The preset default is 3 seconds.

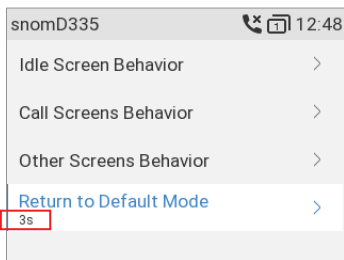

Fig. 11

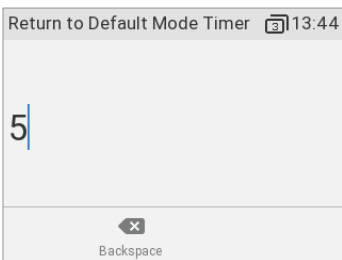

Fig. 12

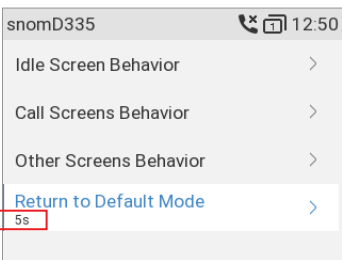

Fig. 13

3. Enter a different number of seconds between 0 and 360 (Fig. 11) on the alphanumeric keypad and press D to save and return to the **SmartLabel options** menu (Fig. 13). The timer now shows the new setting.

Note: If you enter 0 seconds, the display will not return to the default mode automatically.

Timer setting for returning label page to page 1

The page will automatically revert to page 1 after the number of seconds specified in this setting.

1. Press G -> **Preferences** -> **Display** -> **Primary display** (if there is at least one connected expansion module) -> **SmartLabel options**.

2. Select **Return to first page** (Fig. 14) and press . The preset default is 60 seconds (Fig. 15).

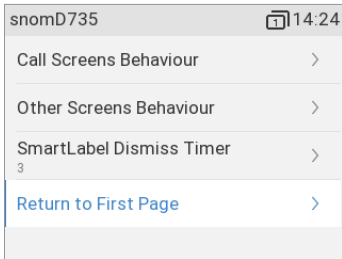

Fig. 14

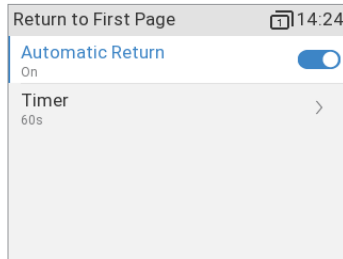

Fig. 15

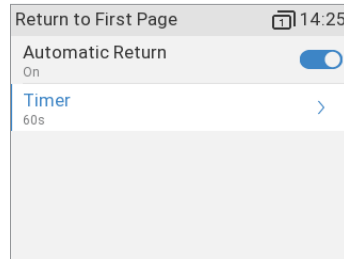



Fig. 16

3. Select **Timer** (Fig. 16) and press .
4. Enter a different number of seconds between 0 and 1209600 seconds (Fig. 17) on the alphanumeric keypad and press  to save and return to the **Return to page 1** menu. The timer now shows the new seconds setting (Fig. 18).

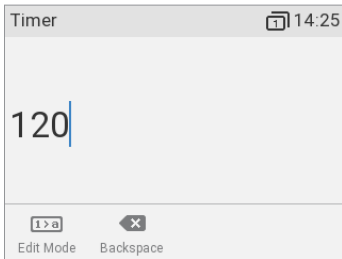

Fig. 17

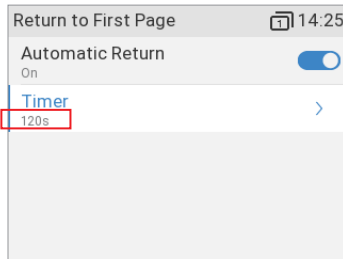

Fig. 18

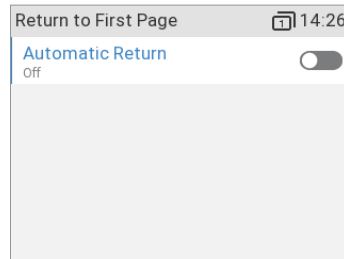

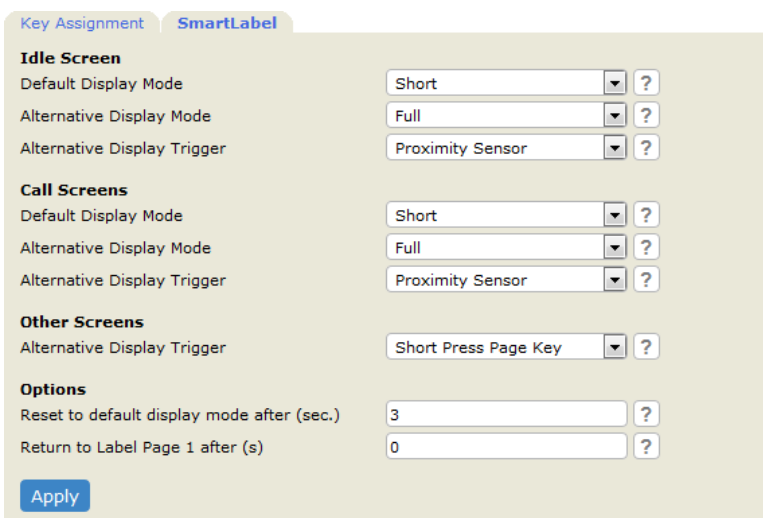

Fig. 19

Note: If you do not want the on-screen page to return to page 1 automatically, select **Automatic return** (Fig. 15), if not already selected, and press  to turn off the function. After the automatic return has been turned off, the **Timer** line is no longer visible in the **Return to first page** menu (Fig. 19).

Settings on the web interface

1. On the phone's web interface, click on **Function Keys** in the menu on the left.
2. Click the **SmartLabel** tab.



- The default settings are indicated in ***bold italic*** in the table. The available options for the three different screens are:

	Idle screen	Call screens	Other screens
Default display mode	<i>Short</i>	<i>Short</i>	-
	Off	Off	-
	Full	-	-
Alternative display mode	<i>Full</i>	<i>Full</i>	-
	Short	Short	-
Alternative mode trigger	Off	Off	<i>Off</i>
	Short-press page key	Short-press page key	Short-press page key
	Long-press page key	Long-press page key	Long-press page key
	<i>Proximity sensor</i>	<i>Proximity sensor</i>	

- Click the drop-down list of the setting you want to change and select a setting.

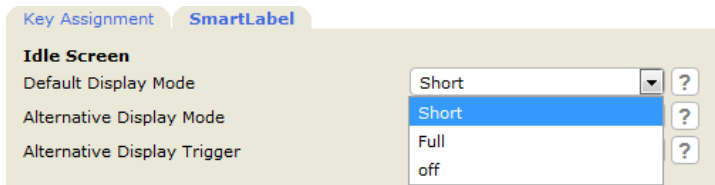

- If you want to change the default timer settings for returning the display mode to the default and the SmartLabel page to page 1, type the number of seconds into the respective text fields.
- Click **Apply** and **Save** before closing the page or opening another page on the phone's web interface.

Customizing the phone settings

See "The phone's web interface" on page 34 on how to open the phone's web interface, how the web interface works, and how to change the settings. See "User mode/administrator mode" on page 37 on the difference between administrator and user mode.

If you have access to administrator mode, but do not consider yourself to be an expert on SIP and SIP phones, we recommend that you do not change any of the technical settings since this may adversely affect the phone's performance or put it out of order altogether.

If you want more information on a web interface setting, click the radio button with the question mark  that you see to the right of each item. It links to a page on Snom's Wiki with detailed information about that particular item.

On customizing the function key settings, see the chapter "Configuring the function keys" on page 69.

Note: Any changes you make on the web interface will not take effect until you click "Apply" and "Save". Changes will be lost if you open another page or tab of the web interface or if you close the web interface without first clicking on **Apply** and **Save**.

Identities/accounts

The phone supports up to four accounts or "phone numbers" with one or more providers or within an office or organization network. On Snom phones these accounts or phone numbers are called "identities".





Note: If your phone is part of an office network, you may need to contact your administrator to configure new or change existing identities, as this can only be done when the phone is running in administrator mode and when the PBX settings allow it.

See "Initializing and registering the phone" on page 14 for more information on required input data.

Configuring and editing identity/account

These settings are available in admin mode only.

On the phone

Press  > **Identity** > **Edit identity** > **Hotdesking** > select a free identity with  and enter account and registrar. If you want or need to enter more data, use  > **Identity** > **Edit identity** > **Edit identity** > select a free identity with  or its number in the menu. Available menu items:

- | | |
|------------------|----------------------------|
| 1 Active [Yes] | 5 Registrar |
| 2 Displayname | 6 Outbound Proxy |
| 3 Account | 7 Authentication User Name |
| 4 Password | 8 Mailbox |

On the web interface

Open the web interface and click an identity in the menu on the left. The configuration window for that identity will open; it contains four tabs, with the left one, **Login**, visible in the front. To view SIP, NAT, and RTP pages, click the respective tab; the font weight of the tab on the active page is **bold**.

- 1. Login tab.** Enter the information received from your provider or your administrator in the appropriate fields.
 - **Display name**

The display name is optional and freely selectable. It will be sent to any parties you call unless you hide your identity (see "Hiding my caller ID" on page 98). If you do not enter a display name, the data in the "Account" text field will be shown on your display and sent to any parties you call unless you hide your identity.
 - **Display text for idle screen**

Any text you enter in this text field will be shown - instead of your display name or account - on your display only. It will not be sent to any parties you call.
 - **Ringtones**

The phone has 10 built-in ringtones that can be assigned to identities, group types, and contact types. It is also possible to download a custom melody and to turn off the ringer by selecting "Silent".

See "Assigning ringtones" on page 90.
- 2. SIP settings.** Click the **SIP** tab to bring the page to the front. It contains a number of technical settings and textfields for entering URIs/URLs to various servers (for music-on-hold, for example), as well as some behavior settings. These are:
 - **Automatic acceptance of incoming calls: Auto Answer.** The default setting is "off".

Acoustic alert (one short beep) when the phone accepts a call automatically: Preferences > Auto Answer > Auto Answer Indication. The default setting is "off".
 - **Contact List.** A contact list must be available on a server. Click "on" and enter the Contact List URI .
 - **Identity can receive calls.** The default setting is "on". If you want to be able to use the identity for outgoing calls but do not wish other phones to be able to call the identity, turn the setting off.
 - **Allow incoming extension monitoring.** If you do not want other phones to be able to monitor the activity on your phone, turn the default setting off.

You can also allow only certain phones to monitor and pick up your calls. In this case, select **On** and enter a password in the next field of the next setting, "Extension monitoring group ID" . **The password cannot start with a "{" bracket.**

Any phone allowed to monitor and pick up your calls must also use the same password in this text field.

Note: If you want the activity on the monitored phones to be displayed on your idle screen, enable the "Go to Call Monitor on Activity" on the **Advanced Settings** page, **Behavior** tab, **Phone Behavior** section.
- 3.** If you have changed the account or the registrar, click **Re-Register** and **Save**. If you have made other changes, clicking on **Apply** and **Save** suffices (see "How the web interface works" on page 36).

Assigning ringtones











The phone has 10 built-in ringtones that can be assigned to identities, group types, and the contact type "VIP". It is also possible to download a custom melody. When an incoming call to an identity is ringing, the phone will play the ringtone assigned to that identity, unless it is a call from a VIP or a group with a distinctive ringer of their own.

Note: Ringers assigned to the contact type VIP and to any of the group types override the ringers assigned to identities. For example, if you have assigned Ringer 1 to one of the identities and Ringer 2 to the group "Colleagues", the phone will play Ringer 2 when a contact from the "Colleagues" group calls that identity.

If your ringtones don't seem to work as expected, contact your administrator. There may be an overriding setting on the PBX.

Assigning ringtones to contact type VIP and group types: See "Ringtones" on page 40.

Selecting identity ringtones:

- **On the phone:** Press  > **Preferences** > **Audio** tab > **Ringer**. If there is more than one configured identity on the phone, they are shown on the display.
 1. Select an identity with  / , if necessary, and press  to hear the current ringtone for that identity. The current ringtone is indicated by the checked radio button .
 2. Selecting a different ringtone.
 - Press  /  to navigate up and down the list of ringtones.
 - Press the function key underneath the symbol  to play the ringtone highlighted by the white bar; press the function key underneath the symbol  to end playback.
 - Press  to save the ringtone highlighted by the white bar as the new ringtone for the selected identity and return to the identity screen.
- **On the web interface** (the ringtones will be played by the phone): **Configuration Identity (1-12)** > Login.
 - Click "Play Ringer" to play the currently selected ringer.
 - To change the ringer, select a ringer from 1 to 10 in the drop-down menu of "Ringtone". If you have selected the custom melody, enter the URL to the data file in the text field underneath. It must be a file of the type PCM 8 kHz 16 bit/sample (linear) mono WAV.
 - Click **Apply** and **Save**.

Date and time formats

Date and time formats can be set on the phone and on the web interface. The defaults are U.S. time format and 24-hour clock (Fig. 1 and 2). European date and time formats are shown in Fig. 3 and 4, U.S. date and time formats in Fig. 5 and 6.

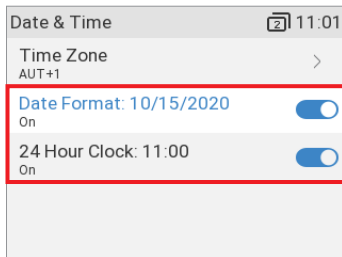

Fig. 1

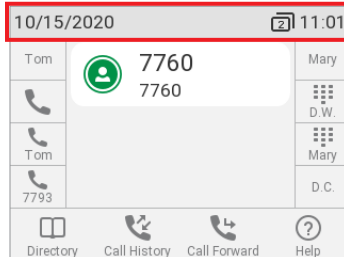

Fig. 2

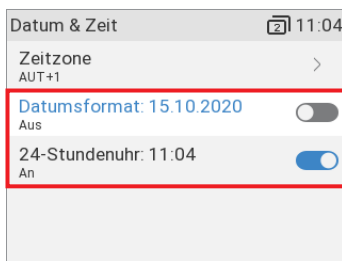

Fig. 3

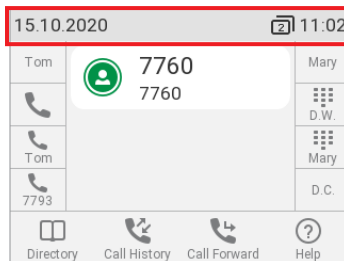

Fig. 4

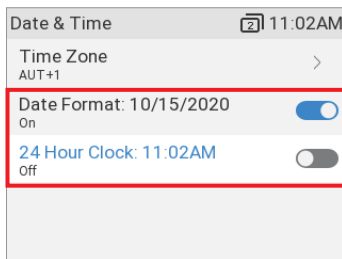

Fig. 5

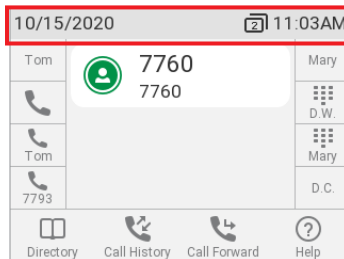

Fig. 6

Date

- Phone settings.

1. Press > **Preferences** > **Date & Time** (see Fig. 1, above).



Date	US Date Format	
	Setting "On"	Setting "Off"
March 5, 2020	03/05/2020	05.03.2020
March 12, 2020	03/12/2020	12.03.2020
December 5, 2020	12/05/2020	05.12.2020
December 10, 2020	12/10/2020	10.12.2020

2. To change U.S. date format from **on** (Fig. 1, above) to **off** (Fig. 3, above), scroll down to **Date format** and press .
3. Press briefly to return to the previous menu or for two seconds to return to the idle screen.

- Web interface settings.
 1. Open the **Preferences** page, **Appearance** tab. The default for the **US Date Format** setting is **on**.
 - Select **on** to have the date shown on the phone's display in "mm/dd/yyyy" format.
 - Select **off** to have the date shown on the phone's display in "dd.mm.yyyy" format.
 2. Click **Apply** and **Save**.

Time

The time setting affects phones and/or firmware versions with a digital clock only. If the phone has a clock face, changing the setting will not affect it.

- Phone settings.
 1. Press  > > **Preferences** > **Date & Time** (see Fig. 1, above).
 2. To change the 24-hour clock setting from **on** (Fig. 1, above) to **off** (Fig. 5, above), scroll down to it and press .
 3. Press  briefly to return to the previous menu or for two seconds to return to the idle screen.
- Web interface settings.
 1. Open the **Preferences** page, **Appearance** tab. The default for the 24 Hour Clock setting in the **General Information** section **on**.
 - Select **on** to have the time on the phone's display shown in 24-hour format, 00:01 to 24:00.
 - Select **off** to have the time on the phone's display shown in AM/PM format, 0:01AM to 12:00PM.
 2. Click **Apply** and **Save**.

Time zone

Note: The time zone setting is accessible in admin mode only.

The phone receives the time and date from your NTP time server. If the time and/or date on the display are incorrect, you may need to set the correct time zone. If you have set the correct time zone and the time is still incorrect, there may be a problem with the time server. Contact your network administrator or your IP provider.

The list of time zones is arranged by the difference in hours (+/-) to the UTC and, within each time zone, alphabetically by selected locations (country or country and city). Selecting and setting the time zone:

On the phone

1. Press  > **Preferences** > **Date & Time** > **Time Zone**.

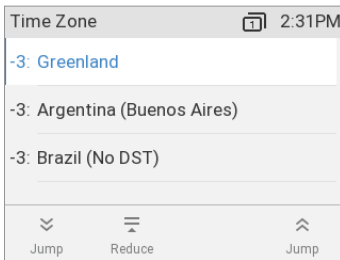

Fig. 1

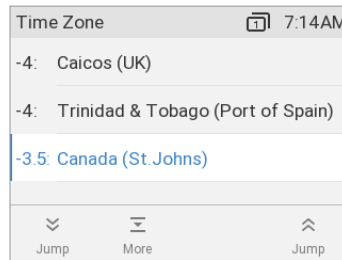

Fig. 2

- Press to collapse the list to show only selected times zones and/or locations where the phone language is spoken. When the phone language is English, all time zones are shown (Fig. 1).
 - When only selected time zones and/or locations are shown (Fig. 2), press to show all.
 - Press / to fast-forward to the beginning of the next or the preceding time zone, respectively.
 - Use / to scroll down or up one item at a time.
2. Press to save your selection
 3. Press briefly to return to the previous menu or for two seconds to return to the idle screen.

On the web interface

1. Open the **Advanced Settings** page, **Network** tab, **Time** section.
2. Select your timezone/country/city from the drop-down list of the **Timezone** setting.
3. Click **Apply** and **Save**.

Language settings of phone and web interface

The language used on the phone can be changed on the phone as well as on the web interface. The language used on the web interface can be changed on the web interface only.

Phone language

Setting on the phone

1. Press > **Preferences** > **Language**.
2. Use / to scroll.
3. Press to save the selected language.
4. Press briefly to return to the previous menu or for two seconds to return to the idle screen.

Setting on the web interface

1. Open the **Preferences** page, **Audio** tab.

2. Select the language from the drop-down list of the **Language** setting.
3. Click **Apply** and **Save**.





Web interface language

1. Open the **Preferences** page, **Audio** tab.
2. Select the language from the drop-down list of the **Web interface language** setting.
3. Click **Apply** and **Save**.

Dial tones

Different dial tones for different countries! Select yours on the phone or on the web interface.

Setting on the phone

1. Press  > **Preferences** > **Audio** > **Tone Scheme**.
2. Use  /  to scroll.
3. Press  to save the selected country.
4. Press  briefly to return to the previous menu or for two seconds to return to the idle screen.

Setting on the Web Interface

1. Open Open the **Preferences** page, **Audio** tab.
2. Select the country from the drop-down list of the **Tone Scheme** setting.
3. Click **Apply** and **Save**.

Emergency numbers

These are numbers that can be dialed when the keyboard is locked. They must be set beforehand on the web interface. The numbers "911", "112", "110", and "999" are preset.

1. Open the **Preferences** page, **General** tab.
2. In the **General information** section, enter the emergency numbers in the text field of the **Emergency Numbers (space separated)** setting. Type each number without spaces between the digits, separate the individual numbers with one empty space between them.

Example: If you want to set the emergency phone number 911 and the phone numbers of your doctor (986543) and a friend (234578), the entry would look this: 911 986543 234578.

3. Click **Apply** and **Save**.

Call forwarding

This feature automatically redirects all or certain incoming calls to another phone or a mailbox. Call forwarding is configured for each identity separately. On the web interface, the settings are configured on the **Configuration identity** (1-12) pages. If you set call forwarding on the phone, the settings are applied to the identity selected as the outgoing identity at the time of the configuration; the configuration must be repeated with the same or different settings for each identity.

Always

All incoming calls are forwarded to the number of the phone, extension, or mailbox specified as this function's target.

When busy

Calls ringing while the phone is busy are forwarded to the number of the phone, extension, or mailbox specified as this function's target.

After timeout

When a call starts ringing, the phone will wait for the number of seconds specified as "call forwarding time". If the call has not been accepted by the end of this time period, it is forwarded to the number of the phone, extension, or mailbox specified as this function's target.

Configuring the settings on the phone

See "Settings on the phone and turning on call forwarding" on page 67.

Configuring the settings on the web interface

If your internet telephony provider or your PBX uses codes to turn functions on and off, refer to their manuals for the codes to enter in "On Code"/"Off Code" text fields or ask your administrator.

Setting forwarding numbers

- Forwarding all incoming calls:
 1. Open the **Configuration Identity** page, **Features** tab.
 2. In the **Call Forwarding** section, type the phone number in the "Target" text field of **Always**. Type each number the way it needs to be dialed by the phone, without spaces or punctuation between the digits.
 3. Click **Apply** and **Save**.
- Forwarding incoming calls when the phone is busy:
 1. Open the **Configuration Identity** page, **Features** tab.
 2. In the **Call Forwarding** section, type the phone number in the "Target" text field of **Busy**. Type each number the way it needs to be dialed by the phone, without spaces or punctuation between the digits.
 3. Click **Apply** and **Save**.

- Forwarding incoming calls when they are not answered:
 1. Open the **Configuration Identity** page, **Features** tab.
 2. In the **Call Forwarding** section, type the number of seconds into the text field of **Timeout (sec)**. If an incoming call hasn't been answered when the time has elapsed, the call will be forwarded to the phone number entered as target.
 3. Type the phone number in the "Target" text field of **Timeout**. Type each number the way it needs to be dialed by the phone, without spaces or punctuation between the digits.
 4. Click **Apply** and **Save**.

Turning call forwarding on

1. Open the **Configuration Identity** page, **Features** tab.
1. In the **Call Forwarding** section, click the radio button **On** for the forwarding event (*Always, Busy, Timeout*) you want to enable.
2. Click **Apply** and **Save**.

Turning call forwarding off





1. Open the **Configuration Identity** page, **Features** tab.
2. In the **Call Forwarding** section, click the radio button **Off** for the forwarding event (*Always, Busy, Timeout*) you want to disable.
3. Click **Apply** and **Save**.

Call completion

On Snom phones call completion means that when a called number is busy or not available, your phone will call you back as soon as the dialed number is not busy anymore or available again. The factory default setting is "off".

Note: This function must be supported by your VoIP provider and/or your PBX.

On the phone

1. Press  > **Call Features** > **Outgoing Calls** > **Call Completion**.
2. Select the setting and press  to change it from off to on and vice versa.
3. Press  briefly to return to the previous menu, press  for two seconds to return to the idle screen.

On the web interface

1. Open the phone's web interface, **Advanced Settings** page, **Behavior** tab.
2. In the **Phone Behavior** section, click the radio button **on** or **off** of the **Call completion** setting.
3. Click **Apply** and **Save**.

Call waiting

Default setting: When in a call, another call coming in is announced visually in the status line and acoustically by a double beep. See "Call waiting" on page 55 on how to use this feature. Available settings:

- **On:** Visual and acoustic announcement of calls waiting
- **Visual only:** Visual announcement by text and/or symbol of call(s) waiting
- **Ringer:** Acoustic announcement by double beeps
- **Off:** No announcement; callers hear the busy signal

Call waiting can be set independently for each identity on the phone's web user interface. If you use the phone to change the setting, it will apply to the current outgoing identity.

Setting on the phone

The setting is applied to the outgoing identity at the time it is saved. If you want to change the setting for other identities, select each one as the outgoing identity in turn and repeat the steps.

1. Press  > **Call Features** > **Incoming Calls** > **Call Waiting**.

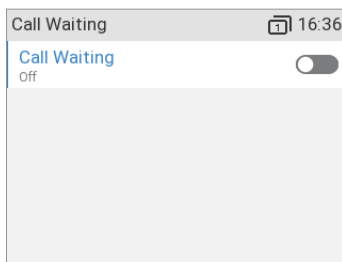

Fig. 1

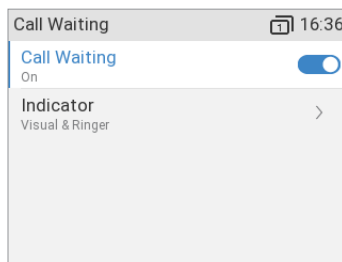

Fig. 2

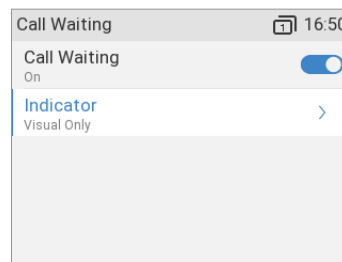

Fig. 3

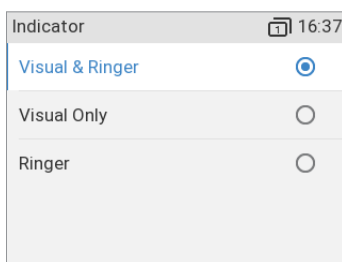

Fig. 4

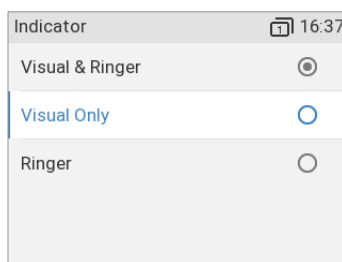

Fig. 5

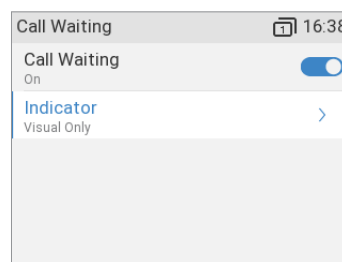







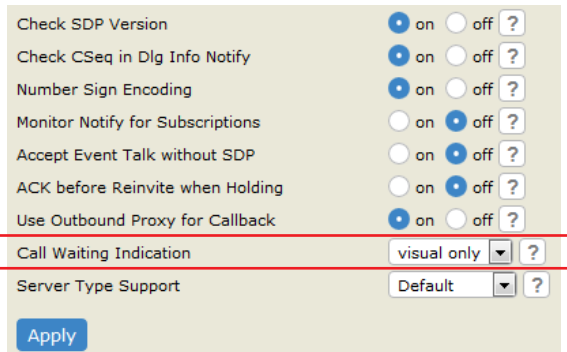

Fig. 6

- To turn call waiting on and off, select **Call waiting** and press . When call waiting is disabled, **Indicator** is not available in the menu (Fig. 1); pressing  enables the function (Fig. 2). When the function is enabled, pressing  turns it off.
 - To change the way calls waiting are announced, select **Indicator** and press . The **Indicator** menu appears (Fig. 3). Select a setting and press  to save the change and return to the **Call waiting** menu. The **Indicator** setting now indicates the new setting, for example, if you changed the default setting of "visual & ringer" (Fig. 5) to "visual only" (Fig. 6).
2. Press  briefly to return to the previous menu, press  for two seconds to return to the idle screen.

Setting on the web interface

1. In the menu on the left, click the identity whose call waiting settings you want to change.
2. Click the **SIP** tab. The setting **Call Waiting Indication** is the second to last on the page.



3. To turn call waiting off, select "off" from the drop-down menu. Select "visual only" or "ringer" if you want waiting calls announced only by the "phone ringing" symbol or by the double beep, respectively.

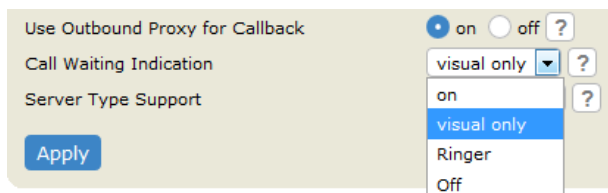

4. Click **Apply** and **Save**.





Hiding my caller ID

With this setting your phone number will not be transmitted to any phones you call. The function must be set for each identity separately. .

Please note that your call may not be accepted if the other phone is set to reject anonymous calls (see next item).

Setting on the phone

On the phone, the function is applied to the identity selected as the current identity for outgoing calls. Select each identity as outgoing identity in turn and select and save the function.

1. Press  > **Call Features** > **Outgoing Calls**.
2. Select **Hide own outgoing ID** and press  to change the setting from **no** to **yes** and vice versa.
3. Press  briefly to return to the previous menu, press  for two seconds to return to the idle screen.

Setting on the web interface

1. Open the **Identity** page of the identity.
2. Click the **Features** tab.





3. In the **Privacy Settings** section select the radio button **Hide** or **Show** of the setting **Suppress own number (CLIP/CLIR)**.
4. Click **Apply** and **Save**.

Rejecting anonymous calls

With this setting you will not receive calls from phones whose number is not shown on your display. Anonymous callers will hear the busy signal.

Please **note** that calls from analog phone connections will, most likely, be received as anonymous calls. The default is off.

Setting on the phone

1. Press  > **Call Features** > **Incoming Calls**.
2. Select **Reject anonymous** and press  to change the setting from **yes** to **no** and vice versa.
3. Press  briefly to return to the previous menu, press  for two seconds to return to the idle screen.

Setting on the web interface

1. Open the **Preferences** page and select the **General** tab if not already selected.
2. In the **Privacy Settings** section, click the radio button **Reject** of the **Reject incoming anonymous calls** setting.
3. Click **Apply** and **Save**.

QuickLookUp (number guessing / auto completion)

When the function is enabled, the phone will propose numbers containing the typed string from the numbers saved on its call lists and in the directory as soon as you have typed the minimum number of digits on the "enter number" display. If there is more than match, select with **▼/▲** on the navigation key and press  to dial.



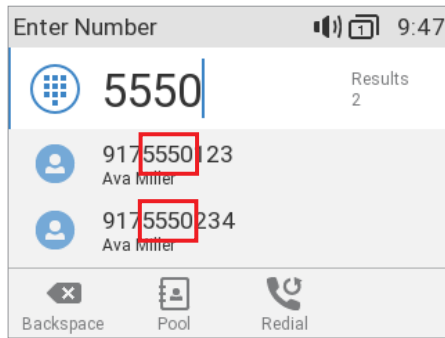

Note: Starting with firmware version 10.1.33.33, the default setting for QuickLookUp is **on**, and the minimum number of characters that must be entered before QuickLookUp starts looking for matches is three. To turn QuickLookup off, open the phone's menu and select **Preferences - General - QuickLookup**.

In earlier versions the default setting for the number guessing (auto completion) function is **off**. To be able to use the functions, open the phone's web interface to the **Advanced Settings** page > **Behavior** tab > **Phone Behavior** section, change the **Number guessing** setting to **on**, and enter the minimum number of characters that must be entered before number guessing will start.

In the following example, the minimum number of characters is four:



Setting on the phone

1. Press  and select **Preferences**.
2. Select **General**.
3. Select **QuickLookup**.
4. Press  to change the setting from **yes** to **no (on / off)** and vice versa to enable or disable the function.
5. When it is enabled, type the number of digits that must be entered into the text field of **QuickLookup Start Length**.
6. Press  briefly to return to the previous menu, press  for two seconds to return to the idle screen.



Setting on the web interface

1. Open the **Preference** page, **Behavior** tab.
2. In the **Contact Search** section, click the radio button to turn the **QuickLookup** function **on** or **off**.
3. Type the minimum number of digits that must be entered into the text field of **QuickLookup Start Length**.
4. Click **Apply** and **Save**.

Speed dial



You can use the numbers 0 to 30 and the special characters # and * to speed dial frequently dialed and/or long numbers without having to enter the complete phone number. The numbers must be set on the phone's web interface first.

1. In the menu on the left side of the phone's web interface, click **Speed Dial**.
2. Enter one phone number with any required prefixes (area code, country code, operator/auto attendant, etc.) in the text field for each respective number or special character in the table.

Speed Dial Table		
0:	<input type="text" value="0114440123"/>	
1:	<input type="text" value="9175550304"/>	

Type each phone number without spaces or punctuation between the digits.



For example: You want to be able to speed dial phone number 555-0784 in area code 917 by pressing the  key. In conventional notation you might write the number down as (917) 555-0784. In the speed dial table, type 9175550784 into the text field of the number 1.

3. Click **Apply** and **Save**. You can now speed dial the number by pressing  and  on the phone.

Note: You can also configure the freely programmable function keys with LEDs (P1–P32) to dial one specific number each. See "Programming the function keys", "Example 3, Speed dialing" auf Seite 80 for the instructions.

Setting a PIN to unlock the keyboard

On the phone

1. Press  and select **Maintenance**.
2. Select **Security**.
3. Select **Set keyboard lock PIN**.
4. Enter the PIN and confirm by pressing .

On the web interface

1. Open the **Preferences** page, **General** tab.
2. In the **Privacy settings** section enter the PIN in the text field of **PIN to unlock**.
3. Click **Apply** and **Save**.

Software update

Manual update

The phone must be running in administrator mode.

1. Open a browser and enter the address <https://service.snom.com>.
2. Click **Firmware** in the navigation bar at the top of the page.
3. Click **Firmware Update Center** in the drop-down list.

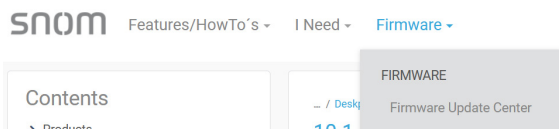

4. Click the release version you want to update to from the list for your type of phone (desk phone, DECT, etc.).

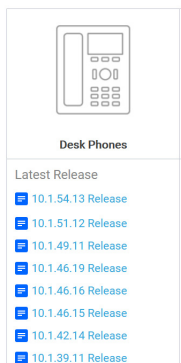

5. On the [FW] RELEASE page, read the release notes.
6. Scroll down to the **Downloads** table.
7. Scroll down to your phone model in the left column of the table.
8. Right-click on the **download link** for SIP-r.bin file of the phone to be updated.
9. Click **Copy link location** or **Copy link address** (the exact wording depends on your browser).
10. Open the phone's web interface and click **Advanced** in the menu on the left side of the display.
11. Click the **Update** tab.
12. In the **Manual Software Update** area, paste the link into the text field of **Firmware**.
13. Click **Load**. The phone begins to reboot.
14. If the phone asks "Reboot?", press .
15. **DO NOT DISCONNECT THE POWER WHILE THE PHONE IS REBOOTING!**

Auto provisioning

For information on auto provisioning, see AUTO PROVISIONING on our webpage <https://service.snom.com>. In the **Contents** menu on the left side, click **Features**, then **Deskphone Features**, and **Auto Provisioning**.





1. Open the phone's web interface and click **Advanced** in the menu on the left side of the display.
2. Click the **Update** tab.
3. Please click the radio button  of each line and read the information on each setting **before** you configure the setting.
4. Click **Apply** and **Save**. If you have the changed the setting URL and/or the PnP configuration, a reboot is required before they will take effect.

Snom Secure Redirection and Provisioning Service (SRAPS)

If you want to use Snom's Secure Redirection and Provisioning Service (SRAPS), click **SRAPS** in the **Contents** menu for more information and the link for signing up.

Troubleshooting

Reboot

1. Press .
2. Select **Maintenance** and press .
3. Select **Reboot** and press .
4. When asked whether to "Reboot?", press .
5. Wait for the idle screen to reappear.





Hard reboot

Disconnect the power, wait for a few seconds, and reconnect. Wait for the idle screen to reappear.

Warning: Never disconnect the power during a firmware update!

Reset to factory values

The phone can be reset to factory values in admin mode only.

1. Press .
2. Select **Maintenance** and press .
3. Select **Reset values** and press .
4. Enter the administrator password and press .
5. Wait for the idle screen to reappear.
6. See "Initializing and registering the phone" on page 14 to continue.

Warning: All customized settings will be lost!

TFTP Update

When there is no other way to get the phone to work (administrator password lost, etc.), it can be reset to factory values via TFTP update. **Note: All information and all customized settings stored on the phone will be deleted!** For information on how to do the TFTP update, see the how-to article on <https://service.snom.com>.

1. Open a browser and enter the address <https://service.snom.com>.
2. Click the **FAQ's** symbol.
3. In the **Contents** menu on the left side of the display, click the arrow of **FAQ**.
4. Click the arrow of **Deskphone FAQ**.

5. Select **How can I set the phone to admin mode**.

Manual initialization

When automatic initialization via DHCP fails, enter the values for netmask, IP gateway, and DNS server manually after each prompt on the display.

Contacting Snom Support

If you are not a Snom partner, please contact your seller, visit our helpdesk at <https://helpdesk.snom.com/support/home> first. You may find the answer to your question or problem in one of the topics there. If you haven't found an answer or a solution to your problem, please post your question or problem on the forum at <https://helpdesk.snom.com/support/discussions>.

Note: The forum is accessible to the general public. Do not post any private and/or security-relevant information there. This includes MAC addresses, SIP headers, etc. that may allow others to hack into your system or use your identity for nefarious purposes.

Submitting a ticket

If you are a Snom partner, log in to the Snom helpdesk and open a ticket: <https://helpdesk.snom.com/support/login>. You'll find the instructions here: <https://helpdesk.snom.com/support/solutions>.

Submitting system and settings information

System information

1. Open the phone's web interface, **System Information** page.
2. Copy the text under System Information into your forum posting or into the email, if Support has asked you to contact them by email.

Make sure to delete the MAC address and the IP address in the public forum posting.

Settings information

1. Open the phone's web interface, **Settings** page.
2. Copy the settings list into your forum posting or into the email, if Support has asked you to contact them by email.

Make sure to delete private and/or security-relevant data like the MAC address, public IP address, etc.

Traces

Snom Support may ask you to submit a SIP Trace and/or a PCAP Trace to help them analyze your problem.

Performing a SIP Trace

1. Open the phone's web interface and click **SIP Trace** in the **Status** menu on the left side of the display.
2. Click **Clear** to clear the page.
3. Recreate the error to be documented in the trace.
4. Click **Reload**.
5. Copy the text and submit to Support in whatever form they requested you to use.

If it is the public forum, make sure to delete private and/or security-relevant data like the MAC address, public IP address, etc.

Performing a PCAP Trace

1. Open the phone's web interface and click **PCAP Trace** in the **Status** menu on the left side of the display.
2. Click **Start** to start recording network traffic.
3. Click Stop to end recording.
4. Click the [here](#) link to open the file download window, and save the file.
5. Submit the file to Support in whatever way they requested you to use.

If it is the public forum, make sure to delete private and/or security-relevant data like the MAC address, public IP address, etc.































Appendix 1 - Display Symbols and Icons

Symbols found in the function key line

The buttons in the left column symbolize the functions that are currently available for activation. Press the function key underneath the symbol to activate the function. The equivalent text symbol used in previous firmware versions is shown in the second column from the left.







































Programmable function symbols

These are the symbols displayed in the function key line when the phone is idle; depending on the firmware version on the phone, the icons may look slightly different. They can be selected on the phone's web interface, **Function Keys** page. See "At a glance" on page 18 for the default settings.

		Line idle
		Server directory
		Call history, call list menu (all, missed, received, and dialed calls)
		Status messages (viewed / new)
		DND (inactive/active)
		Contacts list
		Forwarding all calls (inactive/active)
		Presence signaling
		Voicemail/mailbox (inactive/active)
		Settings menu
		Directory
		IP address of phone and Snom's web address
		Redial (dialed calls)
		Received calls
		Missed calls
		Favorites
		LDAP Directory
		Ringer (active / silenced)
		Next outgoing ID
		Previous outgoing ID
		Reboot
		Monitor calls

Context-sensitive symbols

These are the symbols displayed in the function key line when the phone is active, for example when a call is ringing, when you are dialing, etc.; depending on the firmware version on the phone, the icons may look slightly different.

		Confirming a selection or an action
		Terminating/canceling an action and returning to the previous screen
		Switching input mode to lower case letters
		Switching input mode to upper case (capital) letters
		Switching input mode to numerals
		Deleting the character to the left of the cursor
		Available directories, contact lists, etc.
		Sorting Directory entries
		Editing mode for selected Directory entry
		Deleting selected directory/call list entry
		Details of missed calls (to, from, date/time, total number) and of received and dialed calls (to, from, date/time, duration)
		Deleting entire call list
		Moving to beginning of next time zone
		Moving to beginning of previous time zone
		Expanding the list of time zones to show all
		Collapsing the list of time zones to show only time zones relevant to the language setting (i.e., countries where the language is spoken)
		Put call or conference on hold / unhold (retrieve) call
		Navigate right (forward) to view active call
		Navigate left (back) to view active call
		Navigate right (forward) to view ringing call (call waiting)
		Navigate left (back) to view ringing call (call waiting)
		Navigate right (forward) to view call on hold
		Navigate left (back) to view call on hold
		Establishing conference with all calls on hold / Conference established (active)
		Navigate right (forward) to view conference screen
		Navigate left (back) to view conference screen
		Navigate right (forward) to view one of the conference participants

		Navigate left (back) to view one of the conference participants
		Transfer call
		Transfer call safely
		Casing speaker (inactive / active)
		Headset (inactive / active)
		Microphone (active / muted)

Symbols found in the info bar/status line

The icons in the info bar/status line at the top of the display screen contain information on the current status of the phone, e.g., which page of the SmartLabels is on-screen, which audio device is being used for the current call, whether call forwarding is activated, etc.



















	Call completion active
	SmartLabel page (1–4) on-screen
	Anonymous mode
	Bluetooth mode
	Expansion module connected
	Handset / headset / speakerphone is the active audio device.
	Call forwarding active
	Missed call
	Microphone muted
	Ringer off
	Keypad locked
	SRTP
	Message available
	Voicemail active
	Warning
	WLAN 025, WLAN 050, WLAN 075, WLAN 100, WLAN error
	Error
	VPN active
	Provisioning

SmartLabel function symbols





These are the symbols displayed in the SmartLabel area of the programmable function keys P1–P32 when the function key page with the configured key is on-screen. For information on the configuration of the keys see "Configuring the function keys" on page 69.





























Programmable function symbols

These are the symbols of the functionalities selectable under "Type." Please note that not all available functionalities are represented by a symbol. If the selected type is "Key event", please see the table "Key event symbols," below.

	Action url
	Auto answer off/on
	Busy lamp field
	Conference
	DTMF
	Extension
	Forwarding all calls (turning on/turning off)
	Intercom off/on
	IVR Interactive Voice Response
	Multicast paging is off/on
	Presence
	Push 2 Talk
	Smart transfer
	Speed dial
	Star code
	Transfer current call
	Voice recorder is off/on



Key event symbols

	Call history menu (lists of missed, received, and dialed calls)
	Call history - accepted calls
	Call history - dialed calls
	Call history - missed calls
	Conference





	Contacts / Presence state
	Delete message
	Deny all - reject current and all future calls from the number
	Directory (internal phonebook)
	Push2Talk
	DND (turning on/turning off) (red symbol = DND is on)
	Favorites
	Forwarding all calls (turning on/turning off)
	Headset (select/turn off)
	Help
	Hold
	Login (e.g., hotel)
	Return to previous / move forward to next label page
	LDAP directory
	Settings menu
	Monitor calls
	Multicast zones
	Mute microphone/unmute microphone (red symbol = microphone is mute)
	Select outgoing identity (next/previous)
	OCIP
	Reboot
	Voice recorder is off/on (red symbol = call is being recorded) - check local regulations whether call recording is allowed. Phone does not have built-in voice recorder.
	Redial
	Retrieve voice mail
	Ringer (turn off/turn on)
	Server directory
	Status
	Transfer current call

Display indications



On activity

	Outgoing call ringing
	Incoming call ringing
	Connected (single connection or conference)
	Call disconnected/terminated
	Dialed number is busy
	Holding call
	Call being held by other party

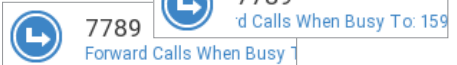
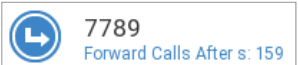
On idle screen

	<p>Outgoing identity</p> <ul style="list-style-type: none"> The current outgoing identity is indicated by a green circle surrounded by a white and a green ring. When you call someone, this is your identity for the call. Select a different identity for the next call by pressing ^ or v on the navigation key.
	<p>Active identity</p> <ul style="list-style-type: none"> Other configured and active identities are indicated by a green circle. Active identities can be called. Active identities can be selected as the outgoing identity for making calls by pressing ^ or v on the navigation key.
	<p>Identity not properly registered</p> <p>By changing the status of an identity to "inactive" on the phone's web interface, it can be deregistered without removing its registration settings. Inactive identities are not shown on the idle screen. They cannot be called or selected as the outgoing identity. To deregister the identity, open the phone's web interface > Configuration Identity (1-12).</p> <ol style="list-style-type: none"> Change the "Identity active" setting to "off". Click "Re-Register". Click "Save".
	<p>Forwarding incoming calls (all, when busy, after timeout):</p>
	  

Appendix 2 - Status Messages

Whenever there is a current message concerning the status of the phone, the function key  will be available. Press the function key or, if it not available,  > 6 Information > 1 Status Info) to open the "Status info" screen. Additionally, some status messages will also be displayed in the status bar; if there is more than one current message, the one with the highest priority will be shown. The messages in descending order of priority:

Status message	Definition
SW ¹	A firmware update is available
Reboot required ¹	Reboot required, for example to have settings changes take effect
SIP disabled ^{1,2}	The phone cannot make calls due to license problems
Error ¹	An error occurred
Low memory ¹	Disk space full
Remote directory is too big ¹	The remote directory is too big to be imported
Not Registered: <account> ^{1,2}	The specified identity/account is not registered
Waiting for <name/number> to be available ²	Waiting for call completion to busy or currently unavailable number
<account> is now available ²	The dialed number is not busy anymore or is now available
Forward when Busy: <name/number>	Call forwarding is on. When your phone is busy, incoming calls will be forwarded to the phone number indicated
Forward after Timeout: <name/number>	Call forwarding is on. When an incoming call is not picked up within the set number of seconds, the call will be forwarded to the phone number indicated
Forward all: <name/number> ²	Forwarding of all incoming calls is on. All incoming calls will be forwarded to the phone number indicated.
Contacting NTP server	Network Time Protocol (NTP) is a protocol for synchronizing clocks over data network. If the connection is interrupted, the phone will not be able to display the correct time.
NTP server unreachable ¹	
HTTP Password not set ¹	No HTTP password has been set
Admin Password not set ¹	No Admin password has been set
Keyboard locked ²	Only numbers designated as emergency numbers can be dialled
DND active ²	Do not Disturb mode is activated
You have messages	There are spoken messages on the mailbox
You have new messages	New (messages on the mailbox)
Old messages	Old (messages on the mailbox)
Missed: <number>	The number of calls you missed since the last time you checked the list of missed calls or turned off the missed call indication

¹ The function key symbol  will blink

² The message cannot be deleted from the "Status Info" screen

Appendix 3 - Wall Mounting

The four screws and two screw anchors/molly bolts/wall plugs appropriate for your type of wall are not included in the delivery.

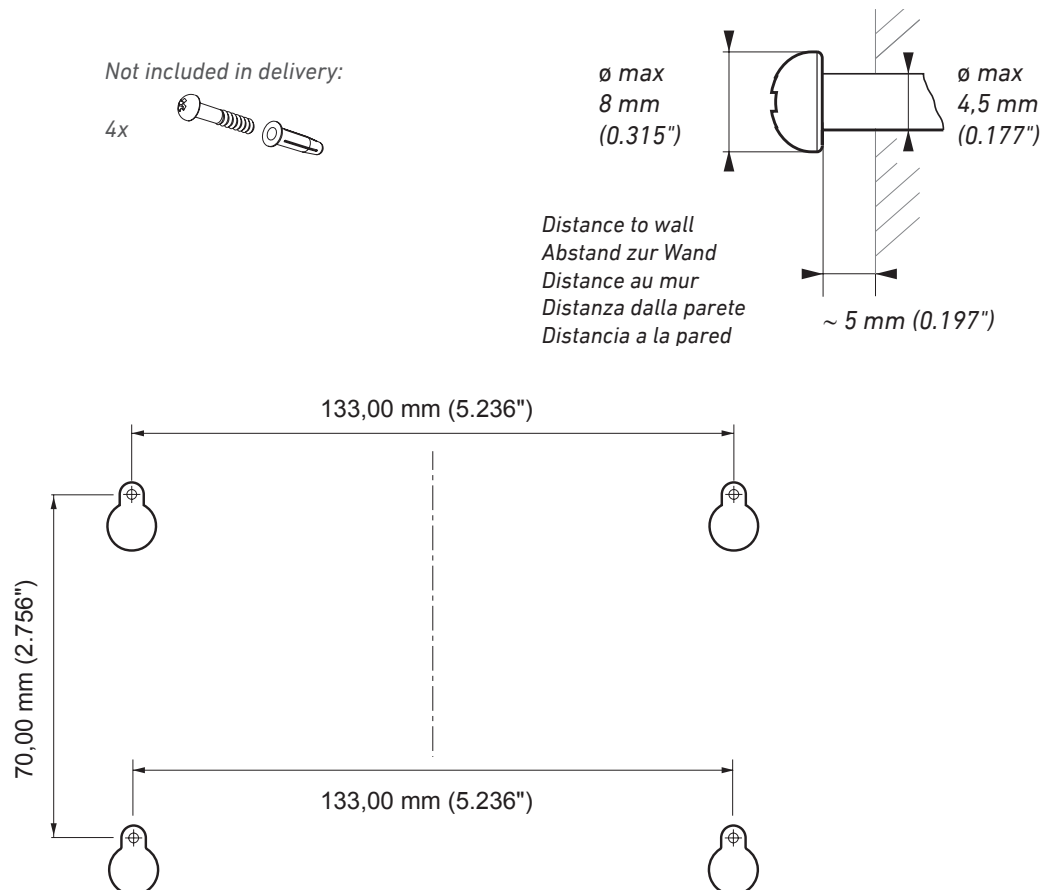

1. Before attaching the footstand in the position for wall mounting, plug the long end of the handset cord into the connector labelled " " on the bottom of the phone and place the cord in the cable guide (Fig. 1).

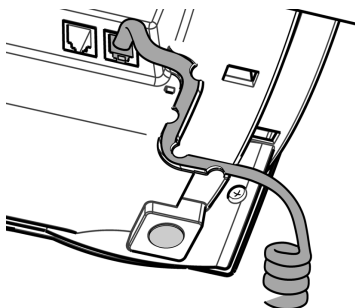

Fig. 1

2. Insert the snap-fits on the longer ends of the footstand into the holes marked ① (Fig. 2).
3. Tilt the footstand away from you and insert the snap-fits on the shorter ends into the holes marked ② (Fig. 2 and 3). Make sure that all four snap-fits have securely locked in place before mounting the phone on the wall.

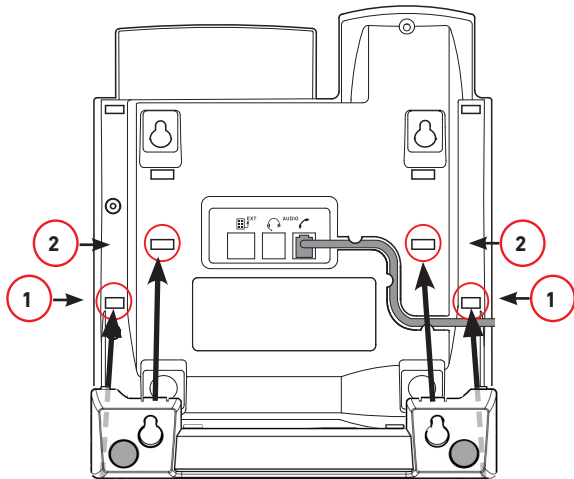

Fig. 2

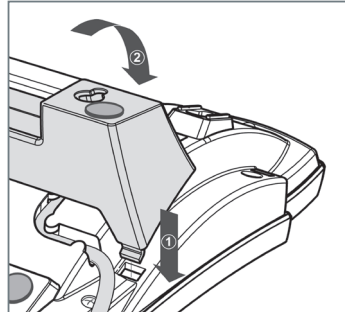

Fig. 3

Note:



To hold the receiver securely in the upright position, we recommend that you rotate the tab of the cradle 180° so that its tip protrudes slightly above the edge of the cradle (see "Rotating the tab of the cradle" on page 11). The small rectangular hole in the receiver casing fits perfectly over the now protruding tip.

Appendix 4 - Programmable Functions

Following is a brief description of the function key settings available on the **Function keys** page of the phone's web interface.



Freely programmable functions

Action URL	Action URLs are basically HTTP GET Requests that allow the phone to interact with web server applications. They can be used to send various data from the phone to a web server, like the customized settings stored on the phone; passwords are replaced by empty strings. Action URLs can be triggered by predefined events ("Action URL Settings" page of the phone's web interface) or manually by a pressing a function key that has been programmed to trigger an action.
Auto Answer	With this setting, your phone will automatically accept incoming calls when it is idle. If you leave the text field empty, incoming calls for all configured identities will be accepted; if you enter the number of an identity in the text field, only calls to that identity will be accepted automatically (i.e., 1 for Identity 1, 2 for Identity 2 etc.).
BLF (Busy Lamp Field)	This function key allows showing the status (idle, ringing, held call, busy) of another extension on the key's LED. By pressing the key, it may also be possible to pick up calls ringing on the extension, to dial the extension when the phone is idle, and to transfer an incoming call ringing on your own extension. These functionalities depend on your PBX; for more information, please check snom's interoperability page and the PBX manual. With Asterisk, generally use this feature rather than extension.
Button	This is a function key that is connected to your PBX to perform a task specified in the buttons document. For more information, see the detailed feature description at http://wiki.snom.com/Features/LED_Remote_Control .
Call Agent	This function key can be used by call agents to perform one of three different functions, depending on the value entered in the "Number" text field: <ul style="list-style-type: none"> Logging onto and off the system. Text field entry: F_CALL_AGENT_LOGGEDIN. Signaling readiness to accept calls. For this function to work, the agent must be logged in. Text field entry: F_CALL_AGENT_READY. Announcing that they are working after a call. For this function to work, the agent must be logged in. Text field entry: F_CALL_AGENT_WORKINGAFTERCALL.

Conference Server	<p>This function key can be used for PBX-based conferences and for local conferences on the phone itself.</p> <ul style="list-style-type: none"> • PBX-based conferences. When a conference room or conference account has been created on the server for an individual identity, you can dedicate a function key to calling and monitoring the conference room. Select the identity and the "Conference server" function from the respective drop-down menus and enter the SIP URI of the conference room in the "Number" text field. For information on how to use this key with your particular PBX, please check the PBX manual. • Phone-based conferences. If there is no SIP URI in the text field, pressing the function key will initiate a phone-based conference with all held calls and any active call.
DTMF	<p>This function allows the specification of arbitrary key sequences (allowed digits: "0-9", "**", "#", "A-D" and flash: "!") which will be sent via DTMF when this key is pressed during an active call.</p>
Extension	<p>This function key allows showing the status (idle, ringing, held call, busy) of another extension on the key's LED. By pressing the key, it may also be possible to pick up calls ringing on the extension, to dial the extension when the phone is idle, and to transfer an incoming call ringing on your own extension. These functionalities depend on your PBX; for more information, please check snom's interoperability page and the PBX manual. With Asterisk, generally use BLF rather than this function.</p>
Forward to	<p>All incoming calls will be forwarded to the number (extension or external phone number) specified under "Number". The key is used to turn forwarding of all calls on and off; the red LED lights up when the function is turned on.</p>
Intercom	<p>Pressing a function key mapped with "Intercom" will establish a two-way connection to the extension specified in the "Number" text field; that extension must have enabled intercom reception on its web interface (Advanced Settings > Behavior tab > Phone Behavior > Intercom Policy "only in idle" or "always").</p> <p><u>"Intercom Policy" settings on the phone being called via intercom:</u></p> <p>Always: The intercom call will connect to the called phone automatically; if the called phone is in a call, that call will be placed on hold.</p> <p>Only in idle: The intercom call will connect to the called phone automatically if the called phone is idle. If it is in a call, the incoming intercom call will be announced as call waiting.</p> <p>Off: Pressing the intercom key will call the extension specified in the "Number" text field where it will be treated like any other incoming call, i.e., ring, be forwarded, etc.</p>



IVR	<p>This function key can be used for regular calls to an extension that is reached via an IVR or auto attendant and a number of voice prompts where the caller has to make a selection by pressing a key after or during the prompt. If you know which keys need to be pressed in which order in order to reach the desired extension, the entire process can be automated and considerably speeded up.</p> <p>The syntax for the "Number" text field entry is <code><phone_number>;dtmf=<n>,<n></code>, etc. The angle brackets <code><></code> including their content are placeholders for the variables that you must replace by the actual characters. The comma represents a pause of one second, and <code>n</code> represents any number key on the alphanumeric keypad.</p> <p>Example: The number to dial is (917) 555-3814. When the connection has been established, the caller will hear three prompts. After the first prompt, he must press key 1; after the second prompt, he must press 3; and after the third prompt he must press 1 to reach the desired extension. The entry in the "Number" text field must look like this: <code>9175553814;dtmf=1,3,1</code>.</p> <p>Usage: When the phone is in idle mode, press the key to dial the number. As soon as the connection has been established, the phone will automatically send the DTMF tones associated with the alphanumeric keys 1, 3, and 1 with a one-second pause between them.</p> <p>(If the function type "IVR" doesn't work on individual phones, try "Speed dial" with the above description.)</p>
Key Event	<p>When this key type is selected, a drop-down menu opens under "Number". For the available selections, see the following section "Key Events".</p>
Line	<p>Default setting for all freely programmable function keys. Incoming calls will go to the first free "line" key, and outgoing calls will use the first free line key.</p> <p>Line keys can be used to make outgoing calls with the identity selected from a particular key's "Context" menu and to have incoming calls for that identity going to that particular function key. If the key is busy, the incoming call will go to the first free line key.</p>
Multicast Page	<p>This function key enables the phone to send multicast streams to IP multicast group addresses. The multicast IP address and port are entered in the "Number" text field in the format <code><multicast IP address>:<port></code> (e.g., <code>239.255.255.245:5555</code>). The angle brackets <code><></code> including their content are placeholders for the variables that you must replace by the actual characters.</p> <p>Please note: This key is for sending multicast streams. To allow reception of multicast streams, multicast support must be enabled on the phone's web interface, Advanced settings > SIP/RTP tab > Multicast by setting Multicast Support to "on". You must also enter the IP addresses of the multicasts you wish to receive in ascending order of priority, 10 being the highest. In case of simultaneous multicasts, the one with the highest priority at any given time will override the others.</p>
Park Orbit	<p>If a park orbit has been set up on the server, a function key mapped with the Park Orbit functionality can EITHER serve to park calls on the park orbit OR to park as well as retrieve calls, depending on the type of server used. Select the server type on the Configuration Identity page of the context identity, SIP tab, from the "Server Type Support" drop-down menu. Enter the "phone number" of the Park Orbit and/or the park position in the text field of "Number", for example <code>orbit1@my.proxy.com</code> or <code>700@my.proxy.com</code> etc.</p>

Presence	If supported by your PBX, the LED of this function key will reflect the presence status (ringing, busy, available, etc.) of the extension specified in the "Number" text field. The function key can also be used to dial the extension, usually when the destination signals availability.
Push2Talk	<p>Pressing the function key mapped with "Push2Talk" will establish a two-way connection to the extension specified in the "Number" text field for as long as the key is pressed; that extension must have enabled intercom reception on its web interface (Advanced Settings > Behavior tab > Phone Behavior > Intercom Policy "only in idle" or "always").</p> <ul style="list-style-type: none"> • On 870 phones, this key type will establish an Intercom connection. • On 820/821 phones, this key type is only available on keys P2 and P3. • On 760 phones, this key type is not available on key P4.
Shared Line	Bridged lines (Bridged Line Appearance (BLA)) are shared by two or more users; when one of them is using the line, the others are blocked from using it. This key type makes it possible to monitor whether a shared line is busy (the LED is lit) or not (the LED is off). The URI of the shared line is set under "Number".
Speed Dial	<p>Besides using the "Speed Dial" page on the web interface to program speed dial numbers, you can also put the functionality on the freely programmable function keys with LEDs to be able to speed dial frequently used and/or long numbers without having to enter the complete phone number.</p> <p>Enter one phone number with any required prefixes (area code, country code, operator/ auto attendant, etc.) in the "Number" text field for any given freely programmable function key with LEDs. Example: 0019175557813.</p> <p>Or enter a partial phone number (country, area code etc.) and complete the number on the dialog screen. In this case, enter the partial number, followed by a semicolon and "number=incomplete" in the text field. Example: 001917555; number=incomplete.</p>
Starcode	<p>Making SIP calls without audiovisual indication on the phone user interface (PUI).</p> <p>Examples for using this feature:</p> <ul style="list-style-type: none"> • Controlling settings on the PBX with dedicated keys that turn PBX functions on and off. The available functions must have been set on the PBX and they must be accessible from the phone, typically by dialing a star code. Phone function keys can be dedicated to activating and deactivating call forwarding and DND mode, transferring, picking up, and parking/unparking calls, etc. Depending on the settings on your PBX, you may either have to dedicate one key each for activating and deactivating a given function or to dedicate one key for both activating and deactivating the function. • Silent alarms or emergency calls. <p>If the standard behavior of this function key type does not meet your requirements, it is possible to customize it. Copy the standard XML configuration of the key from the Settings page of the phone's web user interface (WUI) and edit it to suit your needs. Then paste the edited XML into the "Number" text field and change the key's type to "Xml definition".</p>

<p>Transfer to</p>	<p>Transferring active calls and ringing incoming calls to the number set in the "Number" text field. Pressing the key once will transfer the active or ringing call.</p> <p>If the text field is empty, pressing the key will put the "Enter number" screen on the display. Enter the number and press  /  to complete the transfer.</p> <p>For further information, see the article "Transferring calls" in the chapter "Using the phone".</p>
<p>Voice Recorder</p>	<p>The phone does not record the voice streams at all; they must be recorded on the PBX where a recording account must be set up. Pressing the key when the phone is idle will establish a connection between the phone and the recording account, making it possible to record spoken memos, meetings, or conferences. Pressing the key during a call will establish a three-party conference with the two phones and the recording account as participants. Please be advised that you must respect the legal restrictions of your country for recording calls with or without the participants' knowledge and permission.</p>
<p>Xml Definition</p>	<p>Copy the XML sub tag of the action(s) you want the key to perform into the text field. The currently available settings can be found here: http://wiki.snom.com/Features/Mass_Deployment/Setting_Files/XML/XmlSubTags.</p>

Key Events

<p>ABS</p>	<p>Address book search (OCS accounts)</p>
<p>Accepted Calls</p>	<p>(Accepted List) List of calls accepted on the phone</p>
<p>Call Lists</p>	<p>Call history list (missed, received, dialed calls)</p>
<p>Change active ID</p>	<p>List of registered SIP identities</p>
<p>Conference</p>	<p>Starting a conference</p>
<p>Contacts</p>	<p>Contact List, where the Presence State of selected users can be seen (online, busy, offline)</p>
<p>Directory</p>	<p>Internal phone directory</p>
<p>DND</p>	<p>Turning "Do not disturb" function (DND) on an off. When mapped to a function key with an LED, the LED will light up when DND is turned on.</p>
<p>Favorites</p>	<p>Favorites list</p>
<p>Forward all</p>	<p>All incoming calls will be forwarded to another extension or an external phone number. After turning call forwarding on with this key, the display will prompt you to enter - or confirm/change a previously entered - forwarding number.</p>
<p>Help</p>	<p>FW versions lower than 8: Phone's IP address, MAC address, and firmware version.</p> <p>FW 8 and higher: Phone's IP address and the URI to Snom Wiki. IP address, MAC address, and firmware version can be found in Settings > 6 Information > 2 System Information.</p>
<p>Hold</p>	<p>Placing the active call on hold</p>

LDAP Directory	Allows the user to look up a remote directory while dialing. Once set, this pressed key will open up the Directory Search window. If LDAP is setup, corresponding matching entries as returned by the server will be shown. If LDAP is not used and presence_lookup_number setting is turned on, the contact matches will be shown. The default edit mode is alphanumeric in this state.
Logoff Identities	Caution: This option will delete all account settings!! Usage: Mainly useful for call centers with frequently changing users.
Menu	Calling up the settings menu of the phone
Missed Calls	Missed call history list
Monitor Calls (not available on Snom 300)	When the phone has been programmed to monitor extensions and do/allow call pickup, a key can be mapped to show the list of monitored extensions and do call pickup from the monitor. FW v8.7.2 and higher: The list will show only active extensions (i.e., busy or ringing). When there is no activity on any monitored extensions, the list is empty.
Mute	Mutes/unmutes the microphone (handset, speakerphone, headset) during active call
Next Outgoing ID	Selecting the next identity as the outgoing identity
Presence State	Providing access to a list where the Presence state of each registered SIP Identity can be defined (online, offline, busy, invisible).
Prev. Outgoing ID	Selecting the previous identity as the outgoing identity
Reboot	Rebooting the phone
Record	The phone does not record the voice streams at all; they must be recorded on the PBX or other external device. Pressed during a call, the key informs the PBX to start and stop the recording of the audio stream on the PBX. While the call is being recorded, the recording symbol ● will either blink on the display or be displayed, in red ●, in the status line, depending on the phone type; if the function key has an LED, the LED will be lit throughout the recording. Please be advised that you must respect the legal restrictions of your country for recording calls with or without the participants' knowledge and permission.
Redial	Dialed call history list (last call at the top)
Retrieve	Retrieves new mailbox messages. This key becomes active when the phone has received a message waiting indication (MWI) with a valid mailbox URI.
Status Messages	Currently available status messages (see Appendix 2)
Transfer	Transferring the active call or an incoming call that you do not want to pick up. See the article Transferring calls in the chapter Using the phone . Pressing the key will put the "Enter number" screen on the display. Enter the number and press  /  to complete the transfer.

Appendix 5 - GNU General Public License

COPYRIGHT NOTICE AND WARRANTY DISCLAIMER

I.

Das Produkt enthält Software, die unter der GNU General Public License, Version 2, frei genutzt werden darf.

This Product contains Software applicable to GNU General Public License, Version 2 which can be used freely.

II.

Im Verhältnis zu den Lizenzgebern der Software gilt der folgende Haftungsausschluss:

Towards the licensor of this Software the following liability is disclaimed:

This program is distributed in the hope that it will be useful, but WITHOUT ANY WARRANTY; without even the implied warranty of MERCHANTABILITY or FITNESS FOR A PARTICULAR PURPOSE. See the GNU General Public License for more details.

III.

Der Lizenztext der GPL lautet wie folgt:
The GNU General Public License is as follows:

GNU GENERAL PUBLIC LICENSE

Version 2, June 1991

Copyright (C) 1989, 1991
Free Software Foundation, Inc.
59 Temple Place, Suite 330
Boston, MA 02111-1307, USA

Everyone is permitted to copy and distribute verbatim copies of this license document, but changing it is not allowed.

Preamble

The licenses for most software are designed to take away your freedom to share and change it. By contrast, the GNU General Public License is intended to guarantee your freedom to share and change free software—to make sure the software is free for all its users. This General Public License applies to most of the Free Software Foundation's software and to any other program whose authors commit to using it. (Some other Free Software Foundation software is covered by the GNU Library General Public License instead.) You can apply it to your programs, too.

When we speak of free software, we are referring to freedom, not price. Our General Public Licenses are designed to make sure that you have the freedom to distribute copies of free software (and charge for this service if you wish), that you receive source code or can get it if you want it, that you can change the software or use pieces of it in new free programs; and that you know you can do these things.

To protect your rights, we need to make restrictions that forbid anyone to deny you these rights or to ask you to surrender the rights. These restrictions translate to certain responsibilities for you if you distribute copies of the software, or if you modify it. For example, if you distribute copies of such a program, whether gratis or for a fee, you must give the recipients all the rights that you have. You must make sure that they, too, receive or can get the source code. And you must show them these terms so they know their rights.

We protect your rights with two steps: (1) copyright the software, and (2) offer you this license which gives you legal permission to copy, distribute and/or modify the software.

Also, for each author's protection and ours, we want to make certain that everyone understands that there is no warranty for this free software. If the software is modified by someone else and passed on, we want its recipients to know that what they have is not the original, so that any problems introduced by others will not reflect on the original authors' reputations.

Finally, any free program is threatened constantly by software patents. We wish to avoid the danger that redistributors of a free program will individually obtain patent licenses, in effect making the program proprietary. To prevent this, we have made it clear that any patent must be licensed for everyone's free use or not licensed at all.

The precise terms and conditions for copying, distribution and modification follow.

GNU GENERAL PUBLIC LICENSE

TERMS AND CONDITIONS FOR COPYING, DISTRIBUTION AND MODIFICATION

0. This License applies to any program or other work which contains a notice placed by the copyright holder saying it may be distributed under the terms of this General Public License. The "Program", below, refers to any such program or work, and a "work based on the Program" means either the Program or any derivative work under copyright law: that is to say, a work containing the Program or a portion of it, either verbatim or with modifications and/or translated into another language. (Hereinafter, translation is included without limitation in the term "modification".) Each licensee is addressed as "you".

Activities other than copying, distribution and modification are not covered by this License; they are outside its scope. The act of running the Program is not restricted, and the output from the Program is covered only if its contents constitute a work based on the Program (independent of having been made by running the Program). Whether that is true depends on what the Program does.

1. You may copy and distribute verbatim copies of the Program's source code as you receive it, in any medium, provided that you conspicuously and appropriately publish on each copy an appropriate copyright notice and disclaimer of warranty; keep intact all the notices that refer to this License and to the absence of any warranty; and give any other recipients of the Program a copy of this License along with the Program.

You may charge a fee for the physical act of transferring a copy, and you may at your option offer warranty protection in exchange for a fee.

2. You may modify your copy or copies of the Program or any portion of it, thus forming a work based on the Program, and copy and distribute such modifications or work under the terms of Section 1 above, provided that you also meet all of these conditions:

a) You must cause the modified files to carry prominent notices stating that you changed the files and the date of any change.

b) You must cause any work that you distribute or publish, that in whole or in part contains or is derived from the Program or any part thereof, to be licensed as a whole at no charge to all third parties under the terms of this License.

c) If the modified program normally reads commands interactively when run, you must cause it, when started running for such interactive use in the most ordinary way, to print or display an announcement including an appropriate copyright notice and a notice that there is no warranty (or else, saying that you provide a warranty) and that users may redistribute the program under these conditions, and telling the user how to view a copy of this License. (Exception: if

the Program itself is interactive but does not normally print such an announcement, your work based on the Program is not required to print an announcement.)

These requirements apply to the modified work as a whole. If identifiable sections of that work are not derived from the Program, and can be reasonably considered independent and separate works in themselves, then this License, and its terms, do not apply to those sections when you distribute them as separate works. But when you distribute the same sections as part of a whole which is a work based on the Program, the distribution of the whole must be on the terms of this License, whose permissions for other licensees extend to the entire whole, and thus to each and every part regardless of who wrote it.

Thus, it is not the intent of this section to claim rights or contest your rights to work written entirely by you; rather, the intent is to exercise the right to control the distribution of derivative or collective works based on the Program. In addition, mere aggregation of another work not based on the Program with the Program (or with a work based on the Program) on a volume of a storage or distribution medium does not bring the other work under the scope of this License.

3. You may copy and distribute the Program (or a work based on it, under Section 2) in object code or executable form under the terms of Sections 1 and 2 above provided that you also do one of the following:

- a) Accompany it with the complete corresponding machine-readable source code, which must be distributed under the terms of Sections 1 and 2 above on a medium customarily used for software interchange; or,
- b) Accompany it with a written offer, valid for at least three years, to give any third party, for a charge no more than your cost of physically performing source distribution, a complete machine-readable copy of the corresponding source code, to be distributed under the terms of Sections 1 and 2 above on a medium customarily used for software interchange; or,
- c) Accompany it with the information you received as to the offer to distribute corresponding source code. (This alternative is allowed only for noncommercial distribution and only if you received the program in object code or executable form with such an offer, in accord with Subsection b above.)

The source code for a work means the preferred form of the work for making modifications to it. For an executable work, complete source code means all the source code for all modules it contains, plus any associated interface definition files, plus the scripts used to control compilation and installation of the executable. However, as a special exception, the source code distributed need not include anything that is normally distributed (in either source or binary form) with the major components (compiler, kernel, and so on) of the operating system on which the executable runs, unless that component itself accompanies the executable.

If distribution of executable or object code is made by offering access to copy from a designated place, then offering equivalent access to copy the source code from the same place counts as distribution of the source code, even though third parties are not compelled to copy the source along with the object code.

4. You may not copy, modify, sublicense, or distribute the Program except as expressly provided under this License. Any attempt otherwise to copy, modify, sublicense or distribute the Program is void, and will automatically terminate your rights under this License. However, parties who have received copies, or rights, from you under this License will not have their licenses terminated so long as such parties remain in full compliance.

5. You are not required to accept this License, since you have not signed it. However, nothing else grants you permission to

modify or distribute the Program or its derivative works. These actions are prohibited by law if you do not accept this License. Therefore, by modifying or distributing the Program (or any work based on the Program), you indicate your acceptance of this License to do so, and all its terms and conditions for copying, distributing or modifying the Program or works based on it.

6. Each time you redistribute the Program (or any work based on the Program), the recipient automatically receives a license from the original licensor to copy, distribute or modify the Program subject to these terms and conditions. You may not impose any further restrictions on the recipients' exercise of the rights granted herein. You are not responsible for enforcing compliance by third parties to this License.

7. If, as a consequence of a court judgment or allegation of patent infringement or for any other reason (not limited to patent issues), conditions are imposed on you (whether by court order, agreement or otherwise) that contradict the conditions of this License, they do not excuse you from the conditions of this License. If you cannot distribute so as to satisfy simultaneously your obligations under this License and any other pertinent obligations, then as a consequence you may not distribute the Program at all. For example, if a patent license would not permit royalty-free redistribution of the Program by all those who receive copies directly or indirectly through you, then the only way you could satisfy both it and this License would be to refrain entirely from distribution of the Program.

If any portion of this section is held invalid or unenforceable under any particular circumstance, the balance of the section is intended to apply and the section as a whole is intended to apply in other circumstances.

It is not the purpose of this section to induce you to infringe any patents or other property right claims or to contest validity of any such claims; this section has the sole purpose of protecting the integrity of the free software distribution system, which is implemented by public license practices. Many people have made generous contributions to the wide range of software distributed through that system in reliance on consistent application of that system; it is up to the author/donor to decide if he or she is willing to distribute software through any other system and a licensee cannot impose that choice. This section is intended to make thoroughly clear what is believed to be a consequence of the rest of this License.

8. If the distribution and/or use of the Program is restricted in certain countries either by patents or by copyrighted interfaces, the original copyright holder who places the Program under this License may add an explicit geographical distribution limitation excluding those countries, so that distribution is permitted only in or among countries not thus excluded. In such case, this License incorporates the limitation as if written in the body of this License.

9. The Free Software Foundation may publish revised and/or new versions of the General Public License from time to time. Such new versions will be similar in spirit to the present version, but may differ in detail to address new problems or concerns. Each version is given a distinguishing version number. If the Program specifies a version number of this License which applies to it and „any later version“, you have the option of following the terms and conditions either of that version or of any later version published by the Free Software Foundation. If the Program does not specify a version number of this License, you may choose any version ever published by the Free Software Foundation.

10. If you wish to incorporate parts of the Program into other free programs whose distribution conditions are different, write to the author to ask for permission. For software which is copyrighted by the Free Software Foundation, write to the Free Software Foundation; we sometimes make exceptions for this. Our decision will be guided by the two goals of preserving the free status of all derivatives of our free software and of promoting the sharing and reuse of software generally.

NO WARRANTY

11. BECAUSE THE PROGRAM IS LICENSED FREE OF CHARGE, THERE IS NO WARRANTY FOR THE PROGRAM, TO THE EXTENT PERMITTED BY APPLICABLE LAW. EXCEPT WHEN OTHERWISE STATED IN WRITING THE COPYRIGHT HOLDERS AND/OR OTHER PARTIES PROVIDE THE PROGRAM „AS IS“ WITHOUT WARRANTY OF ANY KIND, EITHER EXPRESSED OR IMPLIED, INCLUDING, BUT NOT LIMITED TO, THE IMPLIED WARRANTIES OF MERCHANTABILITY AND FITNESS FOR A PARTICULAR PURPOSE. THE ENTIRE RISK AS TO THE QUALITY AND PERFORMANCE OF THE PROGRAM IS WITH YOU. SHOULD THE PROGRAM PROVE DEFECTIVE, YOU ASSUME THE COST OF ALL NECESSARY SERVICING, REPAIR OR CORRECTION.

12. IN NO EVENT UNLESS REQUIRED BY APPLICABLE LAW OR AGREED TO IN WRITING WILL ANY COPYRIGHT HOLDER, OR ANY OTHER PARTY WHO MAY MODIFY AND/OR REDISTRIBUTE THE PROGRAM AS PERMITTED ABOVE, BE LIABLE TO YOU FOR DAMAGES, INCLUDING ANY GENERAL, SPECIAL, INCIDENTAL OR CONSEQUENTIAL DAMAGES ARISING OUT OF THE USE OR INABILITY TO USE THE PROGRAM (INCLUDING BUT NOT LIMITED TO LOSS OF DATA OR DATA BEING RENDERED INACCURATE OR LOSSES SUSTAINED BY YOU OR THIRD PARTIES OR A FAILURE OF THE PROGRAM TO OPERATE WITH ANY OTHER PROGRAMS), EVEN IF SUCH HOLDER OR OTHER PARTY HAS BEEN ADVISED OF THE POSSIBILITY OF SUCH DAMAGES.

END OF TERMS AND CONDITIONS

How to Apply These Terms to Your New Programs

If you develop a new program, and you want it to be of the greatest possible use to the public, the best way to achieve this is to make it free software which everyone can redistribute and change under these terms.

To do so, attach the following notices to the program. It is safest to attach them to the start of each source file to most effectively convey the exclusion of warranty; and each file should have at least the "copyright" line and a pointer to where the full notice is found.

```
<one line to give the program's name and a brief idea of what it
does>Copyright (C) <year> <name of author>
```

This program is free software; you can redistribute it and/or modify it under the terms of the GNU General Public License as published by the Free Software Foundation; either version 2 of the License, or (at your option) any later version.

This program is distributed in the hope that it will be useful, but WITHOUT ANY WARRANTY; without even the implied warranty of MERCHANTABILITY or FITNESS FOR A PARTICULAR PURPOSE. See the GNU General Public License for more details.

You should have received a copy of the GNU General Public License along with this program; if not, write to the Free Software Foundation, Inc., 59 Temple Place, Suite 330, Boston, MA 02111-1307 USA

IV.

Den vollständigen korrespondierenden Sourcecode der Software schickt Ihnen die Snom Technology GmbH auf Nachfrage gerne auf einem üblichen Datenträger gegen Erstattung der Herstellungskosten in Höhe von EUR 10,- zu.

Der vollständige korrespondierende Sourcecode kann auch über unsere Website unter http://www.snom.com/gpl_.html?&L=0 herunter geladen werden.

If requested by you, the complete corresponding source code of the Software can be sent by Snom Technology GmbH on a standard data storage medium against the reimbursement of the manufacturing costs of EUR 10.- per unit.

The complete corresponding source code of the Software can also be downloaded from our web site http://www.snom.com/gpl_.html?&L=0.

V..

Weitere Informationen finden Sie auch unter <http://www.snom.com>.

For further information see <http://www.snom.com>.

Snom Technology GmbH
Wittestr. 30 G
13509 Berlin, Deutschland
Tel. +49 30 39 83 3 0
Fax +49 30 39 83 31 11
office.de@snom.com

VTech Communications Inc.
Snom Americas
9020 SW Washington Square Road,
Suite 555
Tigard, OR 97223
Phone support: (339) 227 6160

Snom Technology GmbH
The Courtyard, High Street
Ascot
Berkshire SL5 7HP, UK
Tel. +44 161 348 7500
Fax +44 169 348 7509
office.uk@snom.com

Snom Technology GmbH
6 Parc des fontenelles
78870 Bailly, France
Tel. +33 1 80 87 62 87
Fax +33 1 80 87 62 88
office.fr@snom.com

Snom Technology GmbH
Via Milano 1
20020 Lainate, Italia
Tel. +39 02 00611212
Fax +39 02 93661864
office.it@snom.com

Snom Technology Ltd.
Rm. 828, 5F, No. 285, Sec. 4
Zhongxiao E. Rd., Da'an Dist.
Taipei City 10692, Taiwan
Tel. +886 2 8751 1120
Fax +886 2 8751 1130
office.tw@snom.com

Your specialist retailer - Ihr Fachhändler -
Votre distributeur - Su distribuidor - Il tuo rivenditore:

⌈

⌋

⌋

⌈