

snom

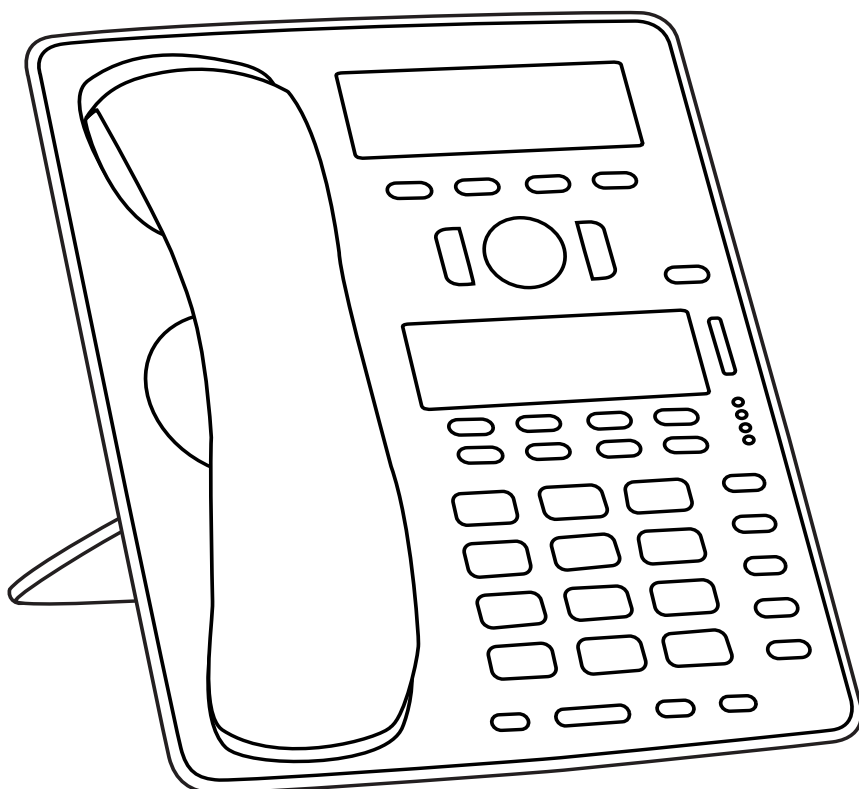

User Manual

# IP Phone D745

## TABLE OF CONTENTS

<b>Copyright, Trademarks, GPL, Legal Disclaimers</b> .....	<b>7</b>
<b>Important information</b> .....	<b>8</b>
Safety instructions .....	8
SELV (Safety Extra Low Voltage) compliance .....	8
Standards conformance .....	9
Product specifications .....	9
Disposal of the device .....	9
Cleaning .....	9
<b>Setting up the phone</b> .....	<b>10</b>
Delivery Content .....	10
Attaching and detaching the footstand .....	10
Wall mounting .....	11
Rotating the tab of the cradle .....	11
Connecting the phone .....	12
Connecting a headset .....	13
Initializing and registering the phone .....	14
Prerequisites .....	14
Initialization .....	14
What to do if initialization and registration are unsuccessful .....	16
Correcting the clock .....	17
<b>Getting to know your phone</b> .....	<b>18</b>
At a glance .....	18
LED indicators .....	20
Call indicator .....	20
Function key LEDs .....	20
Page key LEDs .....	20
MWI key with LED .....	20
Hard keys .....	21
Context-sensitive, programmable function keys .....	21
Navigation, confirmation, and cancel keys .....	21
Preprogrammed, variably programmable function keys .....	21
Page toggle key .....	22
Freely programmable function keys with LEDs .....	22
Function key label screen (second screen) .....	22
Function key page of phone's web interface .....	23

Alphanumeric Keypad .....	24
Input modes and navigation .....	24
Entering numerals, letters, special characters, and symbols .....	25
Display layout .....	26
In idle mode .....	26
When the phone is active .....	28
Settings .....	28
Phone settings .....	28
Settings available in administrator mode .....	29
Settings available in user mode .....	30
Display settings .....	31
Adjusting backlight and contrast on the phone's displays .....	31
Adjusting font size on the phone's function key display .....	32
Adjusting display settings for connected D7s .....	32
The phone's web interface .....	35
Opening the web interface .....	36
How the web interface works .....	37
Web settings overriding manual phone settings .....	37
User mode/administrator mode .....	38
<b>Directories .....</b>	<b>40</b>
Directory .....	40
Definitions, explanations .....	40
Directory entries .....	40
Contact Types .....	41
Outgoing identity .....	41
Group .....	41
Ringtones .....	41
Adding/Editing Entries on the Phone .....	42
Adding new entry manually .....	42
Adding new entry from call list .....	42
Adding current caller .....	42
Sorting entries .....	42
Editing existing entry .....	43
Deleting an entry .....	43
Adding/editing entries on the web interface .....	43
Adding new entry .....	43
Editing an entry .....	44
Deleting entry on web interface .....	46
Dialing from phone directory .....	46

Deleting whole directory .....	46
Importing/Exporting Directory .....	46
External directories .....	47
LDAP .....	47
Contacts .....	47
<b>Using the phone .....</b>	<b>48</b>
Making calls .....	48
Selecting identity for current outgoing call .....	48
Using different audio devices .....	48
Handset .....	48
Headset .....	48
Speakerphone .....	48
Handset or headset and casing speaker .....	48
Using different dialing methods .....	49
Auto dial .....	49
Redialing .....	49
Calling number from call history (missed, received, dialed calls) .....	49
Calling number from phone directory .....	49
Calling number from external directory .....	49
Speed dialing .....	50
Calling emergency numbers .....	50
Call completion .....	50
Number guessing (auto completion) .....	51
Accepting calls .....	51
Using different audio devices .....	51
Automatically accepting calls .....	52
Call pick-up from another extension .....	52
Call waiting .....	53
Active calls .....	54
Hold .....	54
One call on hold .....	54
Holding multiple calls .....	54
Conference .....	55
Initiating a conference .....	55
Conference screen navigation .....	55
Transferring calls .....	56
Attended transfer .....	56
Blind transfer .....	57
Terminating calls .....	58
Missed Calls .....	58



Call lists .....	59
Rejecting or redirecting incoming calls .....	60
Manually .....	60
Automatically .....	60
Rejecting anonymous calls .....	61
Call forwarding .....	62
Making/changing the settings on the phone and turning on call forwarding .....	62
Turning off call forwarding .....	63
Turning forwarding of all calls on/off with a function key .....	64
<b>Configuring the function keys .....</b>	<b>65</b>
Function keys on Snom phones .....	65
Programming the function keys .....	66
Settings on the phone .....	66
Settings on the web interface .....	67
Selected examples for function key programming .....	68
Example 1, Extension monitoring and call pick-up .....	69
Example 2, Extension monitoring and call pick-up on D7 expansion module .....	70
Example 3, Speed dialing .....	71
Example 4, Changing setting of context-sensitive key .....	72
<b>Customizing the phone settings .....</b>	<b>73</b>
Identities/accounts .....	73
Configuring and editing identity/account .....	73
Assigning ringtones .....	75
Date and time formats .....	75
Date .....	76
Time .....	76
Time zone .....	77
Language settings of phone and web interface .....	78
Phone language .....	78
Web interface language .....	78
Dial tones .....	79
Emergency numbers .....	79
Call forwarding .....	79
Call completion .....	81
Call waiting .....	82
Hiding my caller ID .....	82
Rejecting anonymous calls .....	83
Number guessing .....	83
Speed dial .....	84

<b>Software update</b> .....	<b>85</b>
Manual update .....	85
Auto provisioning .....	85
<b>Troubleshooting</b> .....	<b>86</b>
Reboot .....	86
Hard reboot .....	86
Reset to factory values .....	86
TFTP Update .....	87
Manual initialization .....	87
Contacting Snom Support .....	87
Traces .....	88
<b>Appendix 1 - Display Symbols and Icons</b> .....	<b>89</b>
Symbols found in the function key line .....	89
Display indications .....	91
<b>Appendix 2 - Status Messages</b> .....	<b>92</b>
<b>Appendix 3 - Wall Mounting</b> .....	<b>93</b>
<b>Appendix 4 - Programmable Functions</b> .....	<b>94</b>
Freely programmable functions .....	94
Key Events .....	98
<b>Appendix 5 - GNU General Public License</b> .....	<b>100</b>

# Copyright, Trademarks, GPL, Legal Disclaimers

© 2016 Snom Technology Aktiengesellschaft

All Rights Reserved.

Snom, the names of Snom products, and Snom logos are trademarks owned by Snom Technology AG. All other product names and names of enterprises are the property of their respective owners.

Product specifications are subject to change without notice.

Snom Technology AG reserves the right to revise and change this document at any time, without being obliged to announce such revisions or changes beforehand or after the fact.

Texts, images, and illustrations and their arrangement in this document are subject to the protection of copyrights and other legal rights worldwide. Their use, reproduction, and transmittal to third parties without express written permission may result in legal proceedings in the criminal courts as well as civil courts.

When this document is made available on Snom's web page, Snom Technology AG gives its permission to download and print copies of its content for the intended purpose of using it as a manual. No parts of this document may be altered, modified or used for commercial purposes without the express written consent of Snom Technology AG.

Although due care has been taken in the compilation and presentation of the information in this document, the data upon which it is based may have changed in the meantime. Snom therefore disclaims all warranties and liability for the accurateness, completeness, and currentness of the information published, except in the case of intention or gross negligence on the part of Snom or where liability arises due to binding legal provisions.

Our firmware includes some source code that may be used and modified by anyone and everyone under the GNU Public License (GPL) (see "Appendix 5 - GNU General Public License" on page 100), provided they, in turn, make it available to everyone else with the same licensing agreement. Please go to <https://www.snom.com/footer/source-code-gpl-open-source/> for the original GPL license and the source code of components licensed under GPL and used in Snom products.

## Important information

Please read the instructions on safety and disposal and on how to set up and use the device before using it and also give them to other users to read or inform those users of their contents. Save this manual and do not give the device to third parties without it.

## Safety instructions

Follow the instructions in this manual and other applicable documentation of the device.

- If the phone is not supplied with power via an Ethernet cable, use only a power adapter expressly recommended by Snom Technology. Other power supplies may damage or destroy the phone, affect its behavior, or induce noise.
- Avoid placing the cables where people may trip over them or where they may be exposed to mechanical pressure as this may damage them.
- This device is for indoor use only! NOT FOR OUTDOOR USE!
- Do not install the device in rooms with high humidity (for example, in bathrooms, laundry rooms, or damp basements). Do not immerse the device in water and do not spill or pour liquids of any kind onto or into the device.
- Do not install the device in surroundings at risk for explosions (paint shops, for example). Do not use the device if you smell gas or other potentially explosive fumes.
- Do not use the device during thunderstorms. Lightning striking the power grid may cause electric shocks.
- **Warning:** The handset contains a magnet, and its earpiece may attract small dangerous objects such as needles or pins. Please ensure before each use that no such objects are present.

## SELV (Safety Extra Low Voltage) compliance

Safety status of input/output connections comply with SELV requirements.

**Warning:** To avoid electric shock, do not connect safety extra-low voltage (SELV) circuits to telephone-network voltage (TNV) circuits. LAN ports contain SELV circuits, and PSTN ports contain TNV circuits. Some LAN and PSTN ports both use RJ-45 (8P8C) connectors. Use caution when connecting cables.

## Standards conformance

 This device complies with the essential health, safety, and environmental requirements of all relevant European directives.

 This phone is FCC Class B certified and meets US health, safety, and environmental standards.

The declaration of conformity can be requested from

Snom Technology AG  
Wittestr. 30 G  
13509 Berlin, Germany

Unauthorized opening, changing, or modifying the device will cause the warranty to lapse and may also result in the loss of CE conformity and the FCC certification. In case of malfunction contact authorized service personnel, your seller, or snom.

## Product specifications

- **Safety:** IEC 60950
- **Certification:** FCC Class B
- **CE Mark**
- **Ethernet:** 2 x IEEE 802.3/1 Gigabit switch
- **Power:** Power over Ethernet (PoE), IEEE 802.3af, Class 2. If PoE is not available, the Snom power adapter A6 (not included in delivery) can be ordered separately:
  - Snom PN 00004325 (EU)
  - Snom PN 00004326 (US)
- **Connectors:**
  - 2 x RJ45: 1 x LAN, 1 x PC
  - 1 x USB 2.0, type A
  - 1 x proprietary Snom connector for EHS Advanced
  - 2 x 4P4C for handset and optional wired headset (headset not included)
  - 1 x coaxial power connector DC 5V

## Disposal of the device



This device is subject to European Directive 2012/19/EU and may not be disposed of with general household garbage. If you do not know where you may dispose of the device at the end of its lifespan, contact your municipality, your local waste management provider, or your seller.

## Cleaning

To clean the device, use an anti-static cloth. Please avoid cleaning liquids as they might damage the surface or internal electronics of the device.

# Setting up the phone

## Delivery Content

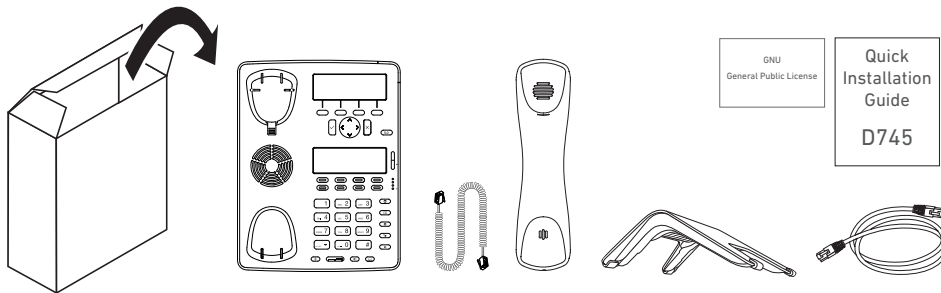

- Base phone unit
- Footstand
- Handset
- Handset cord
- Ethernet cable
- Quick Installation Guide, GNU General Public Licence

## Attaching and detaching the footstand

The footstand can be attached at two different angles: 55° and 33°.

**Note:** Before attaching the footstand to the phone, plug the long end of the handset cord into the connector labelled "H" on the back of the phone and place the cord in the cable guide.

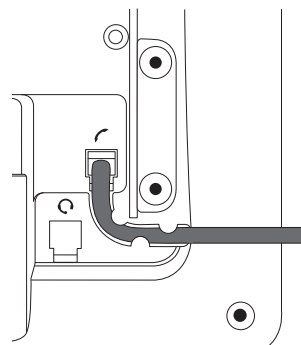

1. Place the top of the grooves on the footstand below the slideguides on the back of the phone.
2. Push the footstand upwards onto the slideguides until they lock in place.

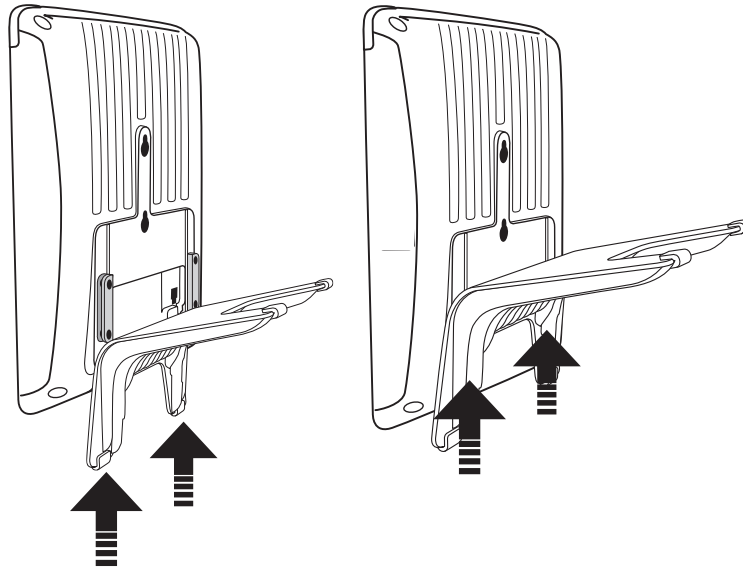

3. Plug the short end of the handset cord into the connector on the handset.
4. Place the phone on an even, horizontal surface.

## Wall mounting

See "Appendix 3 - Wall Mounting" on page 93.

## Rotating the tab of the cradle

The phone is delivered with the tab level with the inner edge of the cradle. If you are going to mount the phone on a wall, we recommend that you rotate the tab 180°. After rotation, the tip of the tab will protrude slightly above the edge of the "cradle". The small rectangular hole in the receiver casing fits perfectly over the now protruding tip, holding the receiver safely in place in the upright position on the wall.

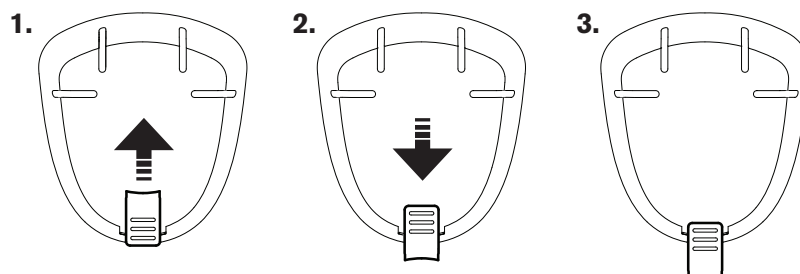

1. Slide the plastic tab from the cradle (Fig. 1)
2. Rotate the tab 180°.
3. Slide the tab back into the cradle (Fig. 2). The top of the tab now protrudes slightly above the inner edge of the cradle (Fig. 3), so that it will hold the handset more securely.

# Connecting the phone

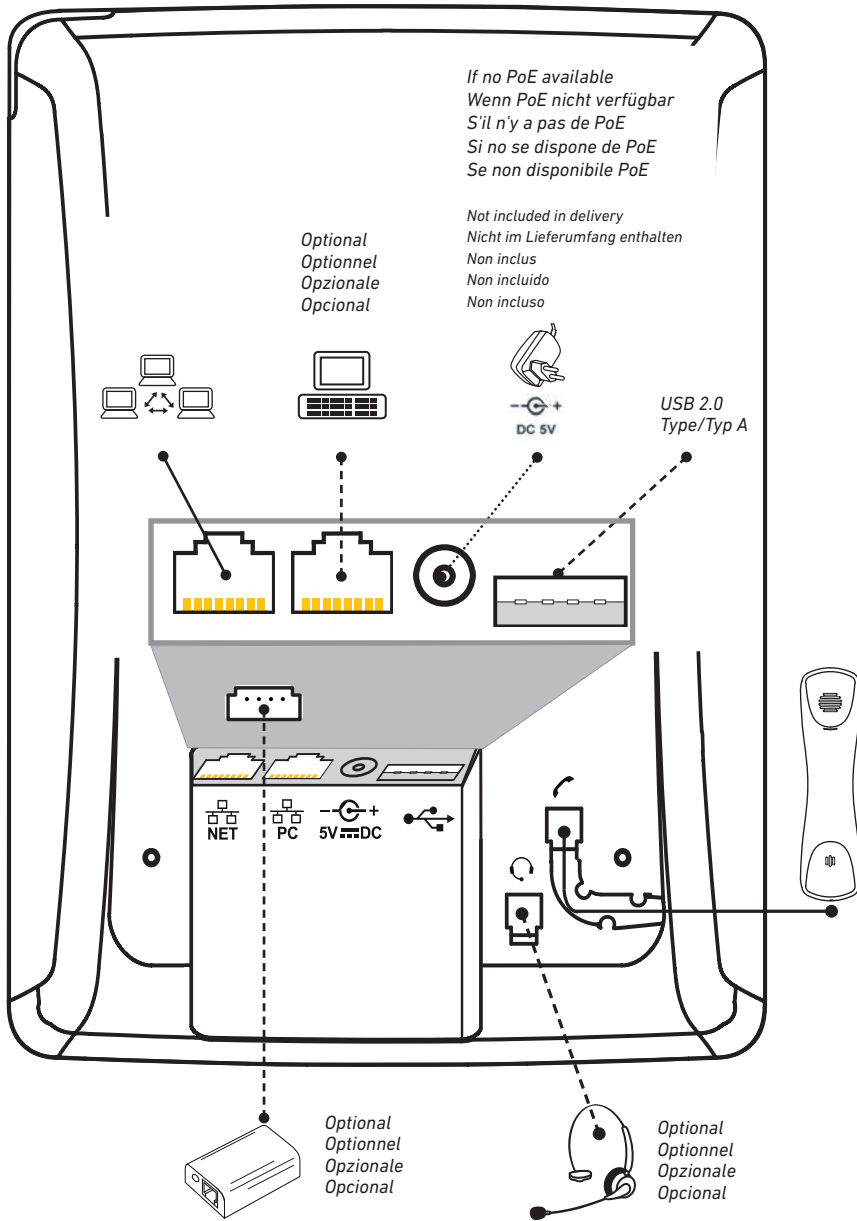

- Optional
- .....• If PoE not available - power adapter not included in delivery

The phone can be operated with Power over Ethernet (PoE) provided via the network cable or, if PoE is not available in your network, with the separately available 5V DC Snom power adapter A6, Snom PN 00004325 (EU)/Snom PN 00004326 (US).

- Plug the Ethernet (network) cable into the RJ45 connector labeled "NET", and plug the other end into the network side to establish a data link.

If PoE is not available, insert the plug of the A6 power supply into the connector labeled "5V DC" and hook up the plug to the wall outlet.



- The second RJ45 connector, labeled "PC", is for daisy-chaining further Ethernet devices without the need for a second Ethernet connection line.

## Connecting a headset

You can use wired as well as wireless headsets with the phone.

- Wired headsets

If you want to use a wired headset, connect it to the RJ audio jack labeled "RJ" .

**Note:** If both a wired and a wireless headset are connected to the phone, incoming calls will go to the wireless headset.

- Wireless headsets

- Connecting the base station of your headset via the Snom EHS Adapter.

Connect the proprietary Snom connector of the 7xx adapter cable to the Snom port  on the back of the phone, as shown in Fig. 1-3, below. **Do not plug it in upside down** (Fig. 4); this will damage the EHS Advanced.

**Note:** The footstand must be removed from the phone to gain access to the connector (see "Attaching and detaching the footstand" on page 10). After you have inserted the plug, make sure that the cable is lying flat against the bottomshell of the phone (Fig. 3) while you are attaching the footstand to the phone. Twisting or curling up the cable may result in damaging the cable and the wires inside it.

Please refer to the Quick Start Guide of the snom EHS Advanced and the manual of your wireless headset for further information on how to connect the snom EHS Advanced and the headset.

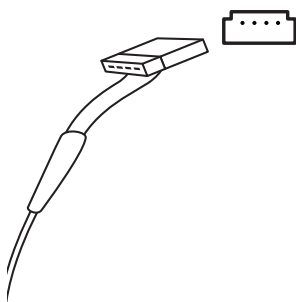

Fig. 1

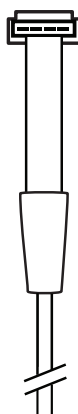

Fig. 2

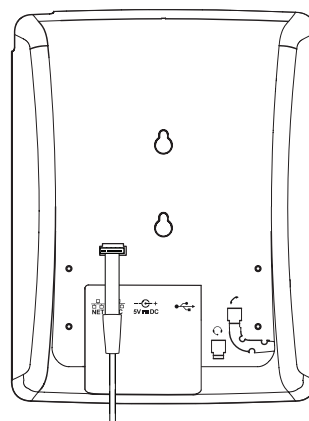

Fig. 3

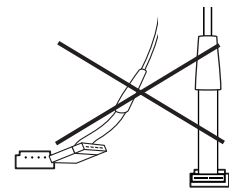



Fig. 4

- Connecting the headset to the phone via a Bluetooth-compatible adapter.

Insert the adapter into the USB port of the phone. See also the Quick Start Guides of the Snom USB BT and the Snom HS BT or the manual of the third-party headset.

**Attention:** The default settings for USB headsets are `VID=0a12:PID=100d:HOOK=38/1` for 8.7.2.11 and higher.

- If your phone is running an earlier firmware version, enter these parameters manually on the phone's web interface at > **Advanced** > **Audio** > text field of "Audio parameters". Click on the question mark  to look up the parameters.
- If you are using a different headset, whatever the firmware version, enter the parameters of the headset manually on the phone's web interface at > **Advanced** > **Audio** > text field of "Audio parameters". Click on the question mark  to find out which parameters you need to use for your respective headset.

## Initializing and registering the phone

### Prerequisites

To be able to use VoIP, you or your company must have:

- A broadband internet connection.
- Access to the internet via a router. This could be a separate device available in various versions from many different manufacturers or in the form of a router on a server or a PC.
- Account information provided by your network administrator or a VoIP account with a VoIP service provider who supports the VoIP SIP standard. The phone supports up to 12 VoIP accounts with one or more VoIP providers.

The registration information received from your Internet service provider or your network administrator may differ and may contain required and optional data. The required data normally includes:

- Account (usually the phone number). On Snom phones, an account is called an "identity".
- Registrar
- Password



User name, authentication name, and outbound proxy may also be required. These are settings that can only be configured on the web interface of the phone after it has been successfully registered. If your provider or your network provides a mailbox account, that setting is also configured on the web interface. For more information, see "Identities/accounts" on page 73.

### Initialization

Snom phones are plug-and-play. Once the phone is connected to your network, it will begin to initialize.

**Note:** Normally the initialization is completely automatic, using DHCP. If the phone cannot discover a DHCP server in the subnet, you will be asked: Are you using DHCP?

If your network does not support DHCP, press  and enter the IP address, netmask, IP gateway, and DNS server manually. Ask your Internet service provider or your network administrator for them.

Watch the display and, when asked to, make selections with ▲▼ on the navigation key  and save with .

1. You will be prompted in English to select a language. Use ▲▼ to select another language, if applicable, and press  to save the highlighted language.
2. Next, you will be prompted in the language of your choice to select a time zone. This affects the time shown on your display.

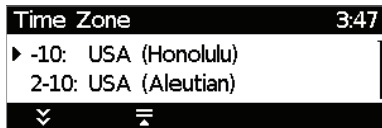

Fig. 1

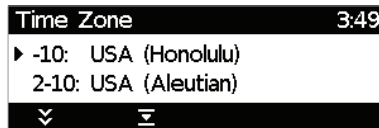

Fig. 2

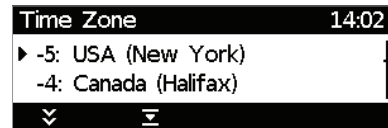



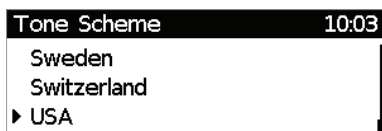

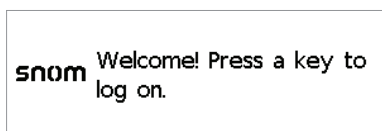



Fig. 3

- Press ▲▼ to move up or down the list one item at a time. When all time zones are shown (Fig. 1), you also have the option to jump to the beginning of the next time zone by pressing the function key underneath .
  - Press the function key underneath  to show only those time zones where the selected phone language is spoken. If you have selected English, all time zones are shown.
  - Press the function key underneath  to show all time zones and all countries or cities within the individual time zones, if there are any (Fig. 2).
  - Press  to save the selected time zone (Fig. 3).
3. Next, you will be prompted to select the tone scheme of a country. This affects the dial tone you hear when you pick up the receiver. Different countries use different dial tones.



- Press ▲▼ to move up or down the list one item at a time.
  - Press  to save the selected country's tone scheme.
4. The display shows the "Welcome" screen. Press any key to log on.



5. Enter the account number and save with .



**Note:** See "Entering numerals, letters, special characters, and symbols" on page 25 on how to enter numbers and letters.

6. Enter the registrar and save with .



7. If required, enter the password received from your Internet service provider or administrator and press .

After successful registration you will see the phone symbol  and the registered account (identity) in the identity line underneath the date/time bar:



**Note:** If you see the account on the display preceded by  and the phone is not working, the server may be down, either for servicing or due to a malfunction. The registration and initialization should be completed as soon as the server is up and running again. You may want to check with your administrator or your provider if nothing happens within a reasonable amount of time.

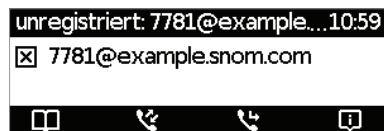

## What to do if initialization and registration are unsuccessful

Your network or your VoIP provider may require more login data than requested by the Snom phone during the initialization and registration process. This data is entered on the web interface of the phone. Contact your network system administrator or your VoIP provider for more information.

1. When you have received all necessary data, open the phone's web interface. See "Opening the web interface" on page 36 for more information.
2. Open Configuration Identity 1 and enter any additional login information you have received from your provider. See "Identities/accounts" on page 73 for more information.

**Note:** A number of IP telephony service providers and a number of SIP PBXs require settings that are different from Snom's standard factory settings. Snom's web page lists numerous providers and PBXs that have been tested for interoperability with our phones and specific settings that may be required. Do not change the standard configuration unless you know what you are doing. Expert help may be required.

## Correcting the clock

The phone receives the time and date from your NTP time server. If the time and/or date on the display are incorrect, you may need to set the correct time zone.

- Changing the settings on the phone and on the web interface: See "Time zone" on page 77.

If the time is still incorrect, there may be a problem with the time server. Contact your network administrator or your IP provider.

### Default formats:

- **Time.** 24-hour clock, e.g. 17:35. Changing to AM and PM formats: See "Time" on page 76.
- **Date.** US date format MM/DD/YEAR, eg. 11/23/2010. Changing to European format DD.MM.YEAR, e.g. 23.11.2010: See "Date" on page 76.

# Getting to know your phone

## At a glance

The factory settings at a glance:

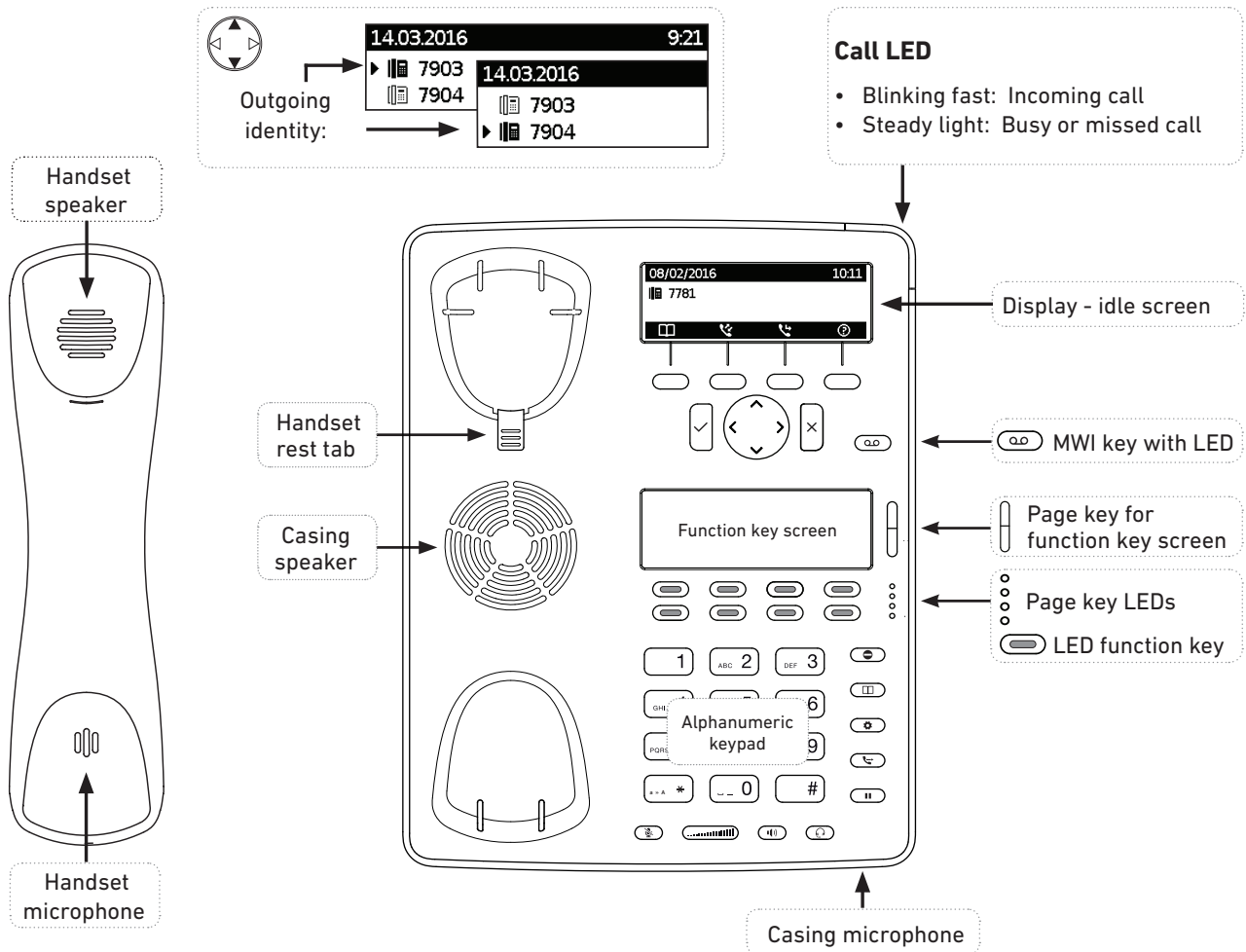



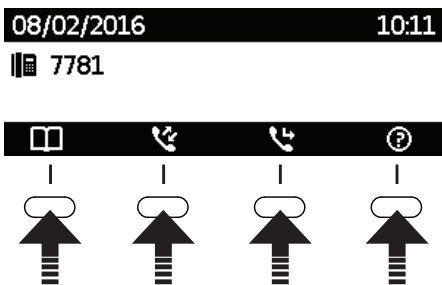



### Context-sensitive, programmable function symbols and function keys







Press the function key underneath the display symbol to activate the function, open the list etc. depicted by the symbol above the key.



Standard functions available on idle screen. Default settings and icons depend on firmware installed on phone.

-  Internal phone directory
-  Call lists (missed, received, dialled calls)
-  /  Forwarding all calls (turning CFwd on/off)
-  Status information (call forwarding active, passwords not set, missed calls, etc.) or, if no status info,  to show phone's IP address and URL to Snom's Wiki

**Audio control keys**



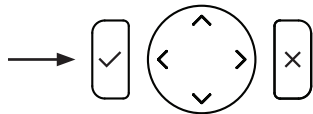



-  Adjusting the volume
  - of the ringer when the phone is idle or ringing
  - of the handset/casing loudspeaker when in a call
-  Mute/unmute microphone
-  Toggling between handsfree and handset mode. Press to dial number and accept calls on speakerphone.
-  Headset mode on/off

**Navigation keys**

- Confirming, saving actions & input, and returning to previous screen
  - Accepting calls on speakerphone and in headset mode
  - **From idle screen: Dialed calls (redial)**
  - From idle screen: Select outgoing identity
  - In other contexts: Navigate up ▲/down ▼ (settings, lists)
- 
- Canceling actions & input, and returning to previous screen
  - Terminating calls on speakerphone and in headset & handset modes
- 
  - From idle screen: Received calls
  - In other contexts: Navigate/space left



  - From idle screen: Missed calls
  - In other contexts: Navigate/space right

**Dedicated, customizable function keys**

-  MWI key with LED
  - LED is lit when message is waiting on mailbox (if mailbox supplied on PBX)
  - Press key to listen to message(s)
-  Turn DND (do not disturb) on and off. Callers hear the busy signal.
-  Directory
-  Settings menu
-  Transfer
-  Hold

**Freely programmable, self-labeling LED keys P1 - P32** 

Default setting: Line

- Fast-blinking LED: Incoming call. Press key or  to accept
- Steadily lit LED: In call
- Slow-blinking LED: Call on hold

**Star key** 

- In editing mode:
  - Press for one second to change input mode (numerals > lower case > upper case)
  - Press briefly to type \*
- On idle screen: Press for 3 seconds to **lock/unlock the keypad**

**Pound (hash) key** 

- In editing mode: Press briefly to type #

## LED indicators

### Call indicator

The bright-red LED situated at the top of the display indicates incoming, ongoing, held, and missed calls. It will be:

- Blinking rapidly when a call is coming in
- Glowing steadily when dialing, when in a call, and when you have missed a call. To turn the LED off after a missed call, press the left arrow ◀ on the navigation key to open the **Missed calls** menu and simultaneously turn off the LED.
- Blinking slowly when you have put a call on hold

### Function key LEDs

Depending on the function mapped onto the key, the red or green LEDs on the key will be activated when the key event occurs. The factory setting is red LED and "line". The LEDs of a line key will:

- blink rapidly when a call is ringing on the line;
- glow steadily when there is an ongoing call on the line;
- blink slowly when a call is on hold on the line;
- be off when the line is free.

When other functions are mapped onto the keys, the LEDs may glow or blink. For example: When the "extension" function has been mapped onto a key and monitoring of extensions is enabled on both phones, the LED will

- blink rapidly when a call is ringing on the extension;
- glow steadily when the extension is busy;
- be off when the extension is not busy

### Page key LEDs

Page				Toggle key
1	2	3	4	
●	○	○	○	
○	●	○	○	
○	○	●	○	
○	○	○	●	
The four LEDs underneath the page toggle key indicate which page is on-screen at the moment. The default setting after reboot is page 1, indicated by the uppermost LED being lit. Pressing the top or bottom end of the toggle will bring the preceding or the next page, respectively, on-screen.				

### MWI key with LED

The LED glows red when there is a new message on the mailbox.



# Hard keys



## Context-sensitive, programmable function keys

These function keys can be programmed on the **Function Keys** page of the phone's web interface with a number of key events; these functions will then be available when the phone is in idle mode. For more information, see "Configuring the function keys" on page 65. For the factory default settings, see "At a glance" on page 18.

You cannot change the functions that are available when the phone is active, e.g., when you are in a call, when the phone is ringing, etc. Depending on the activity, different functions will be available.





## Navigation, confirmation, and cancel keys

can be programmed with the key events available in their drop-down menus. See "Configuring the function keys" on page 65 for further information. Factory settings:

Navigation key		
	<ul style="list-style-type: none"> <li>▲</li> <li>▼</li> </ul>	<ul style="list-style-type: none"> <li>On idle screen: Press to select identity for outgoing calls</li> <li>In other contexts: Moving up and down lists one item/button at a time</li> </ul>
	◀	<ul style="list-style-type: none"> <li>In text fields, press to move the cursor to the left one character at a time.</li> <li>On idle screen, press to open list of received calls.</li> </ul>
	▶	<ul style="list-style-type: none"> <li>In text fields, press to move the cursor to the right one character at a time.</li> <li>On idle screen, press to open the list of missed calls and simultaneously turn off the missed call LED</li> </ul>
	<ul style="list-style-type: none"> <li>Press to accept calls on speakerphone and in headset mode.</li> <li>Press to confirm actions/settings and return to preceding screen.</li> <li>On idle screen: Redial.</li> </ul>	
	<ul style="list-style-type: none"> <li>Press to terminate calls on speakerphone and in headset and handset modes.</li> <li>Press to cancel actions and return to preceding screen.</li> </ul>	

## Preprogrammed, variably programmable function keys

The factory settings is printed on the key. Other functionalities can be programmed onto them. See "Configuring the function keys" on page 65 for more information.

	Message key. The LED of the key is lit when a new message is waiting on the mailbox. Press the key to retrieve messages.
	Phone directory. See "Directory" on page 40 for further information.
	Settings menu. See "Settings" on page 28 for further information.
	Transfer. See "Transferring calls" on page 56 for further information.

	Hold key. See "Hold" on page 54 for further information.
	<p>Turn "do not disturb" (DND) mode on and off for all identities registered on the phone (Fig. 1). If you want to turn on DND for one or more, but not all of the identities (Fig. 2), use the identity settings on the phone's web user interface. In DND mode incoming calls do not ring; callers hear the busy signal.</p> <p><b>Exception:</b> Phone numbers on your directory's VIP list (see "Contact Types" on page 41). When DND is on, you'll see the DND symbol on the display.</p>
<p><i>Fig. 1 - DND active for all identities</i>                      <i>Fig. 2 - DND active for one of the configured identities</i></p>	

### Audio Control Keys

	<p>Press the right or left edge of the key to adjust the volume</p> <ul style="list-style-type: none"> <li>• of the ringer when the phone is idle or ringing</li> <li>• of the loudspeaker in handset, casing, or headset, respectively, when in call</li> </ul>
	Muting and unmuting the microphone
	<ul style="list-style-type: none"> <li>• Toggling between handsfree and handset mode</li> <li>• Dialing numbers on speakerphone</li> <li>• Accepting calls on speakersphone</li> </ul>
	<p>Toggling between headset and handset modes.</p> <p><b>Note:</b> Handset mode overrides headset mode. When the handset is picked up, the headset symbol in the status line will be replaced by the handset symbol, indicating that you can now use only the handset for the call. The phone will return to headset mode when the handset is placed in the cradle, and the headset symbol will reappear in the status line.</p>

### Page toggle key

	Page toggle key for function key screen (second screen). Press the top or bottom rim of the key to put the next "page" of four key label "pages" on screen.
--	-------------------------------------------------------------------------------------------------------------------------------------------------------------

### Freely programmable function keys with LEDs

These 4 x 8 = 32 freely programmable function keys can be programmed and labeled on the phone and on the **Function Keys** page of the phone's web interface. For information on how to map functions onto these keys, see "Configuring the function keys" on page 65. The factory default setting is line.

#### Function key label screen (second screen)

The phone has a second screen where the labels of the freely programmable function keys are displayed on four (4) "pages" with two rows of four (4) labels each. The top row is associated with the top row of LED function keys, the bottom row with the bottom row of LED function keys. The four

LEDs located to the right of the LED function keys indicate which function key page is on-screen at the moment, i.e., page 1 when the uppermost LED is lit, etc. (Fig. 2).

The LED of the associated key will react in accordance with the visible key's mapping; pressing the key will affect its visible setting.

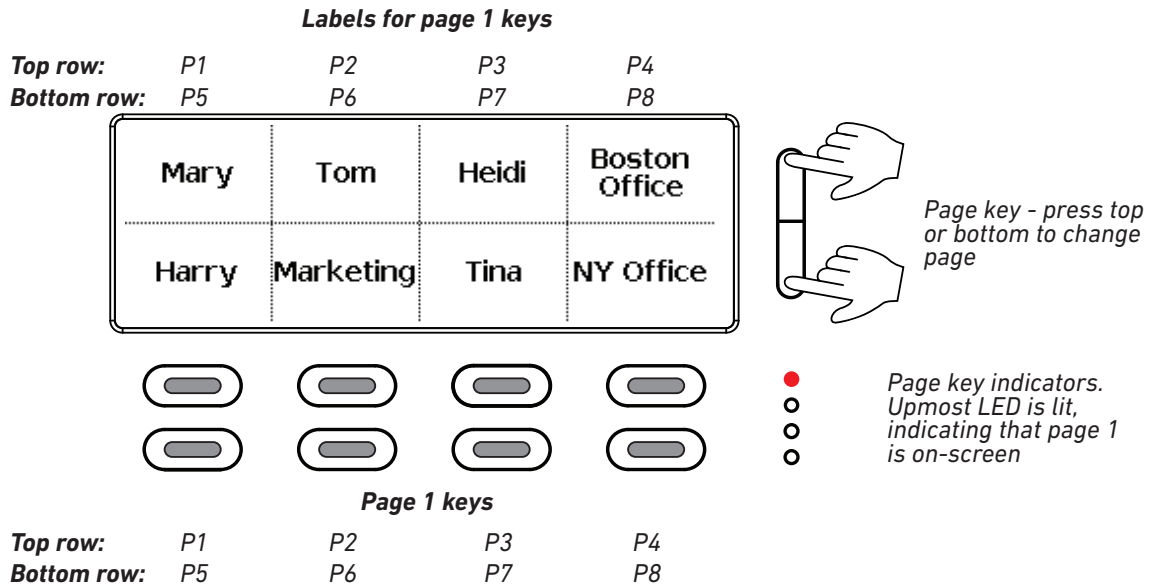

Fig. 1

Page			
1	2	3	4
●	○	○	○
○	●	○	○
○	○	●	○
○	○	○	●

Page 1: Keys P1 - P8

Page 2: Keys P9 - P16

Page 3: Keys P17 - P24

Page 4: Keys P25 - P32

Fig. 2

### Function key page of phone's web interface

For more information on opening and using the phone's web interface, see page 24; for information on programming the function keys, see "Configuring the function keys" on page 65.

Context	Type	Number	Short Text	
Active	Extension	<sip:180@example.snom.c	Mary	P1
Active	Extension	<sip:181@example.snom.c	Tom	P2
Active	Extension	<sip:182@example.snom.c	Heidi	P3
Active	Speed Dial	6175550123	Boston Office	P4
Active	Extension	<sip:183@example.snom.c	Harry	P5
Active	Extension	<sip:184@example.snom.c	Marketing	P6
Active	Extension	<sip:185@example.snom.c	Tina	P7
Active	Speed Dial	2125550123	NY Office	P8
Active	Extension	<sip:186@example.snom.c	Accounting	P9
Active	Line	<sip:187@example.snom.c	Shipping	P10

Fig. 3 - Page 1 keys on phone's web interface

When expansion modules are connected to the phone, they will also be shown on the function key page of the phone's web interface, below the phone's function keys and above the **Apply** button.

Context	Type	Number	Short Text
<b>Expansion Module 1</b> tile layout ▾			
Active ▾	Extension ▾	<sip:7901@example.sno	Accounting Karin 1
Active ▾	Extension ▾	<sip:7902@example.sno	Accounting Mick 10
Active ▾	Line ▾		2
Active ▾	Line ▾		11
Active ▾	Line ▾		3
Active ▾	Line ▾		12
Active ▾	Line ▾		4
Active ▾	Line ▾		13
Active ▾	Line ▾		5
Active ▾	Line ▾		14
Active ▾	Line ▾		6
Active ▾	Line ▾		15
Active ▾	Line ▾		7
Active ▾	Line ▾		16
Active ▾	Line ▾		8
Active ▾	Line ▾		17
Active ▾	Line ▾		9
Active ▾	Line ▾		18

Fig. 4 - Function keys of one connected D7 expansion module

## Alphanumeric Keypad

### Input modes and navigation

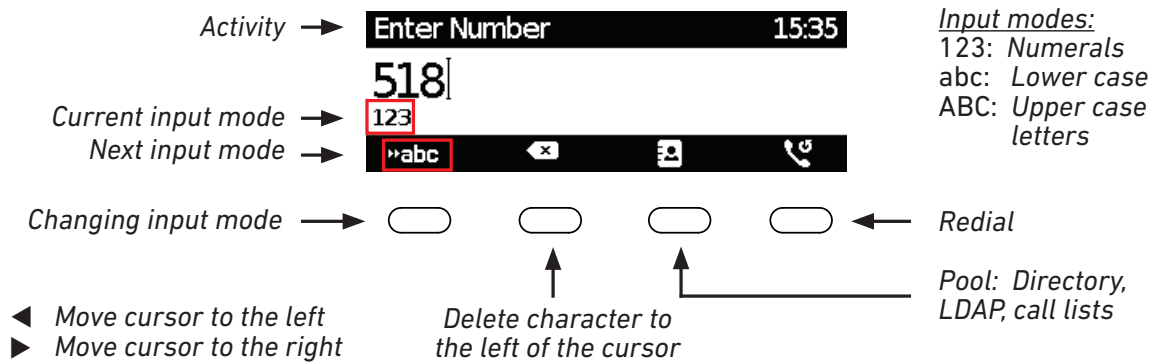

Press any key on the alphanumeric keypad or pick up the handset to open the "Enter Number" screen. The current input mode is indicated underneath the cursor. Press the left function key underneath the display to switch to the input mode indicated by the symbol directly above it in the function key line.

Text underneath cursor = current input mode	Press function key to switch to input mode indicated by symbol in function key line
123	»abc
abc	»ABC
ABC	»123

**Entering numerals, letters, special characters, and symbols**

When entering letters and special characters, pause briefly after each character until the cursor has moved forward so that you won't overwrite the last character you entered. Pausing is not necessary when entering numerals.

**Numerals.** In numeral mode, press the respective number key to type the number printed on the key.

**Letters.** When in input modes lower and upper case letters, press the alphanumeric key with the respective letter one, two, three, or four times quickly to type the first, second, third, or fourth letter printed on the key. Pause briefly after each letter.

**Example:** In lower case letter mode, press the "2" key once to type an "a", twice to type a "b", and three times to type a "c".

**Letters with accents and umlauts.** When in input modes lower and upper case letters, press the alphanumeric key with the basic form of the respective letter as many times as necessary. Pause briefly after each letter. Available letters with accents and umlauts depend on the phone's language setting.

**Example:** If the phone language is German, press key "2" four times to type "ä".

**Entering special characters and symbols.** In input modes lower and upper case letters, press keys "0" and "1" one or more times quickly. Pause briefly after each character or symbol.

- Period. Press "1" once.
- Space (" "). Press "0" once.
- Underscore ("\_"). Press "0" twice.
- Special characters listed in the following table. Press "1" as many times as indicated:

1x	.	2x	+	3x	@	4x	1	5x	:	6x	,			
7x	?	8x	!	9x	-	10x	_	11x	/	12x	\	13x	(	
14x	)	15x	;	16x	&	17x	%	18x	*	19x	#			
20x	<	21x	=	22x	>	23x	\$	24x	[	25x	]			

## Display layout

For the function key display, see "Freely programmable function keys with LEDs" on page 22.

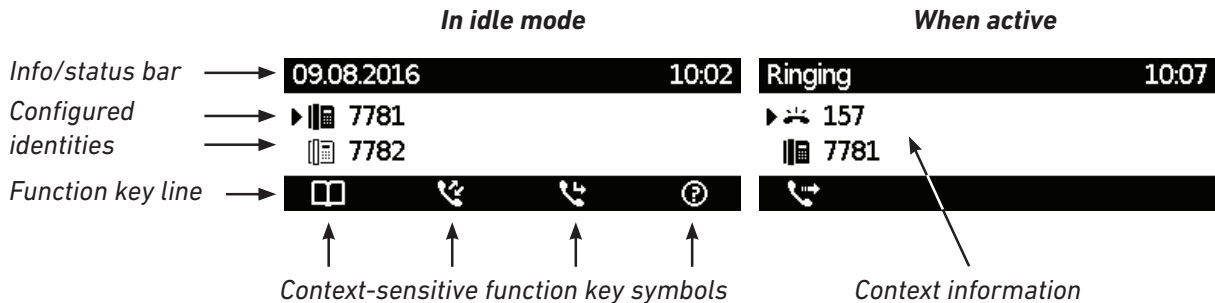

Fig. 1





### In idle mode

In idle mode, the display presents the following information:





#### Info bar/status line

- When there are no status messages or if they have been deleted until the next reboot: Date and time.
- When there are status messages: Any of numerous messages concerning the current status of the phone might be displayed in this bar, for example the availability of a firmware update, a reboot being required, etc. If there is more than one current status message at any one time, the one with the highest priority will be shown. Some of the status messages you may see in idle mode are:
  - The text "Missed:" and the total number of missed calls since the last time you turned off the missed call indication (the text in the info bar as well as the call LED). The missed calls will remain in your missed call list, however.
  - The texts "Forward All:", "Forward when busy:", or "Forward after timeout:" and the phone number calls will be forwarded to.
  - The warnings "HTTP Password not set" and "Admin Password not set". They can be turned off by either setting the passwords or turning them off manually.

Deleting or temporarily suppressing status messages:

- Messages will be deleted automatically when the underlying cause is removed, i.e., call forwarding is turned off, HTTP password is set, etc.
- Temporarily suppressing messages: Press , if the button is available, or  > Information > 1 Status info to open the "Status info" screen. Use ▲ / ▼ to select an item from the list. Press  to view details of the selected item, if available; press  to delete the selected item.

**Context area:** Configured identities.

  	<p><b>Outgoing identity</b></p> <ul style="list-style-type: none"> <li>The current outgoing identity is indicated by a black phone symbol and the extension number or name. If there is more than one active identity, the black phone symbol is preceded by an arrow:  7903. When you call someone, this is your identity for the call.</li> <li>Select a different identity for the next call by pressing ▲/▼ on the navigation key.</li> </ul>
	<p><b>Active identity</b></p> <ul style="list-style-type: none"> <li>An active identity that is not the current outgoing identity is indicated by a white phone symbol.</li> <li>Can be called</li> <li>Can be selected as the outgoing identity for making calls by pressing ▲/▼ on the navigation key</li> </ul>
	<p>Identity not properly registered</p>







**Note:** Identities can be deactivated without removing the registration settings by changing their status to "inactive" on the phone's web interface. Inactive identities are not displayed on the idle screen. They cannot be called or selected as the outgoing identity. To deactivate the identity, open the phone's web interface > **Configuration Identity** (1-12).

1. Change the "Identity active" setting to **off**.
2. Click on **Re-Register**.
3. Click on **Save**.

For information on configuring new identities or modifying existing ones, see "Identities/accounts" on page 73.

**Function key line**

The symbols on the buttons in this line depict the functions that can be activated by pressing the function key underneath the respective symbol. See "Appendix 1 - Display Symbols and Icons" on page 89 for a complete list. The factory defaults are:

	<p>Directory. See "Directory" on page 40.</p>
	<p>Call lists. See "Call lists" on page 59.</p>
 	<p>Forwarding all calls (on/off). See "Call forwarding" on page 62 and 79.</p>
	<p>Pressing this key will put the IP address of the phone on-screen. If another function is mapped onto the key or if the key has been replaced by  because of new status messages, IP address and URL can also be looked up in the settings menu:  &gt; 6 Information &gt; 3 Help.</p>



Displaying all currently available status messages. This key is available whenever a status message becomes newly available even when a different function is mapped onto the far-right function key underneath the display.

Press the key to display the status messages; press  to delete the highlighted status message. When all messages have been deleted, the symbol will disappear from the function key line; the message in the status line will also disappear.

The function mapped onto the key is now available on this key again. If you have mapped the "Status messages" function onto the key, the key will remain blank until a new status message becomes available or until a reboot when all current status messages will be displayed anew.

## When the phone is active

The display will inform you of any activity the phone is engaged in (see Fig. 1 on page 26). This information is presented in the form of text or symbols or both.

**Info/status bar.** Name of current activity and time.

### Context area

Depending on the activity, this area will contain symbols (incoming call ringing, outgoing call ringing, list entries, etc.) and text like the phone number calling, the extension number being called, conference partners, etc.



### Function key line

Depending on the current activity of the phone, the key function key line will present various functions that can be activated by pressing the function key underneath the respective symbol. See "Appendix 1 - Display Symbols and Icons" on page 89 for a list of available functions.

## Settings

A comparatively small number of settings can be adjusted on the phone; many more are available on the phone's web interface.

### Phone settings

Press  to open the settings menu on the display. To open submenus and settings, press their number on the alphanumeric keypad or scroll to the setting and press .



**Settings available in administrator mode**

All settings of the phone menu and on the phone's web interface are accessible.

1 Preferences	2 Call Features	3 Identity	4 Network	5 Maintenance	6 Information
<b>1 Date &amp; Time</b>	<b>1 Call forwarding</b>	<b>1 Outgoing identity</b>	<b>1 IP Settings</b>	<b>1 Security</b>	<b>1 Status info</b>
1 Time zone	1 Forward all	<b>2 Reregister user</b>	1 IPv4	1 User mode <sup>(3)</sup>	<b>2 System info</b>
2 US date format	2 Forward when busy	<b>3 Edit user</b>	2 IPv6	2 Set keyboard lock PIN	<b>3 Help</b>
3 24-hour clock	3 Forward after timeout	1 Hotdesking	<b>2 Webserver</b>	3 Webserver	
4 Time	<b>2 Outgoing calls</b>	2 Edit user	1 Webserver type	1 Webserver type	
5 Date	1 Auto dial	<b>4 Logoff user</b>	2 User name	2 User name	
6 NTP server	2 Auto redial on busy	<b>5 Logoff all</b>	3 Password	3 Password	
<b>2 Tone scheme</b>	3 Number guessing	<b>6 Call voicemail</b>	<b>3 VLAN</b>	<b>2 Reboot</b>	
<b>3 Ringer</b>	4 Call completion		1 VLAN ID	<b>3 Reset values</b>	
<b>4 Language</b>	5 Hide own outgoing ID		2 VLAN Priority	<b>4 Check for SW update</b>	
<b>5 Display</b>	<b>3 Incoming calls</b>		3 Reset VLAN	<b>5 Vision</b>	
1 Contrast	1 Reject anonymous		<b>4 WLAN</b>		
2 Contrast 2d display	2 Call waiting		1 Scan WLAN networks		
3 Font size 2d display	3 Auto answer indication		2 Manual setup		
4 Backlight on activity			3 Switch off WLAN		
5 Backlight when idle			<b>5 Ethernet detection</b>		
6 Expansion modules			<b>6 802.1X</b>		
1 Appearance					
2 Backlight on activity					
3 Backlight when idle					
4 Contrast					
<b>6 Fkeys</b>					
1 Feature keys					
2-5 Line keys, page 1 - 4					
3 Keys on SXM/UXM <sup>(1)</sup>					
<b>7 Wireless techn<sup>(2)</sup></b>					

<sup>(1)</sup> Only when expansion modules are connected to the phone.

<sup>(2)</sup> Only if phone model has a built-in adapter for wireless technology.

<sup>(3)</sup> Pressing this key will put the phone in user mode; many settings will not be accessible (see next page). The administrator password will be needed to return the phone to admin mode.

**NOTE:** The factory default administrator password is 0000 (4 x zero). For security reasons, we recommend that you set your own administrator password. **Be sure to write it down and store it in a safe place** because if it is lost or forgotten, you will not be able to return the phone from user to administrator mode and gain access to all phone settings.

**Settings available in user mode**

1 Preferences	2 Call Features	3 Identity	4 Maintenance	5 Information
<b>1 Date &amp; Time</b>	<b>1 Call forwarding</b>	<b>1 Outgoing identity</b>	<b>1 Security</b>	<b>1 Status info</b>
1 US date format	1 Forward all	<b>2 Reregister user</b>	1 Administrator mode <sup>(3)</sup>	<b>2 System info</b>
2 24-hour clock	2 Forward when busy	<b>3 Call voicemail</b>	2 Set keyboard lock PIN	<b>3 Help</b>
3 Time	3 Forward after timeout		<b>2 Reboot</b>	
4 Date	<b>2 Outgoing calls</b>		<b>3 Check for SW update</b>	
<b>2 Tone scheme</b>	1 Auto dial			
<b>3 Ringer</b>	2 Auto redial on busy			
<b>4 Language</b>	3 Number guessing			
<b>5 Display</b>	4 Call completion			
1 Contrast	5 Hide own outgoing ID			
2 Contrast 2d display	<b>3 Incoming calls</b>			
3 Font size 2d display	1 Reject anonymous			
4 Backlight on activity	2 Call waiting			
5 Backlight when idle	3 Auto answer indication			
<b>6 Expansion modules</b>				
1 Appearance				
2 Backlight on activity				
3 Backlight when idle				
4 Contrast				
<b>6 Fkeys</b>				
1 Feature keys				
2-5 Line keys, page 1 - 4				
3 Keys on SXM/ UXM <sup>(1)</sup>				
<b>7 Wireless techn<sup>(2)</sup></b>				

<sup>(1)</sup> Only when expansion modules are connected to the phone.  
<sup>(2)</sup> Only if phone model has a built-in adapter for wireless technology.  
<sup>(3)</sup> Pressing this key will put the phone in administrator mode. The administrator password is needed to return the phone to admin mode.  
**NOTE:** The factory default administrator password is 0000 (4 x zero). If it doesn't work, someone changed it. Please ask your administrator or your IP Service Provider.

Most of the individual settings are described elsewhere in this manual: See "Using the phone" on page 48 and "Customizing the phone settings" on page 73.

## Display settings

Backlight and contrast on the displays of the phone and on the displays of any connected expansion modules can be adjusted separately for the times when the phone is active and when the phone is idle. Lowering backlight intensity lowers the energy consumption of the devices. The backlight when idle can be reduced to zero vertical bars.

**NOTE:** When the phone has been inactive for a specified number of seconds it will switch the backlight to idle mode. This setting is available only on the phone's web user interface, not on the phone itself. The phone setting is applied to all D7 extension modules connected to the phone, as well.

### Adjusting backlight and contrast on the phone's displays

- **Intensity of backlight.** The setting adjusts the intensity of the backlight for both displays.

1. Press .
2. Press **1 Preferences**.

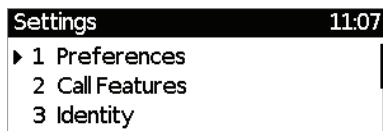



Fig. 1

3. Press **5 Display**.
4. Press **4 Backlight on activity** or **5 Backlight when idle** (Fig. 2).
5. Press the right or left arrow on the navigation key or the function key underneath the right or left arrow in the function key line (Fig. 3 and 4) to increase (▶) or decrease (◀) the backlight's intensity.

6. When done, press  to save and return to the **Display** menu (Fig. 2).

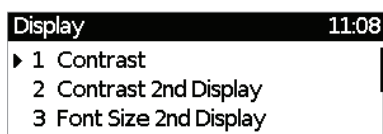

Fig. 2



Fig. 3

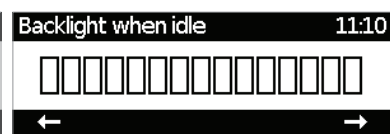

Fig. 4

- **Period of inactivity.** The number of seconds after which the phone will switch from backlight on activity to idle backlight can be set on the phone's web interface only.

1. Open the phone's web interface (see "Opening the web interface" on page 36).
2. Click on **Preferences** (see "How the web interface works" on page 37).
3. Enter the number of seconds in the text field of "Dim after (in seconds)" (in the **General Information** section). The default is 20 seconds.
4. Click on "Apply" and "Save".

- **Contrast.** The contrast on the phone's main display and on the second display, i.e. the function-key screen, is adjusted separately.

1. Press .

2. Press **1 Preferences** (see Fig. 1 on page 31).
3. Press **5 Display**.
4. Press **1 Contrast** if you want to adjust the contrast of the main display (Fig. 5). Press **2 Contrast 2d Display** if you want to adjust the contrast of the function key display (Fig. 6).

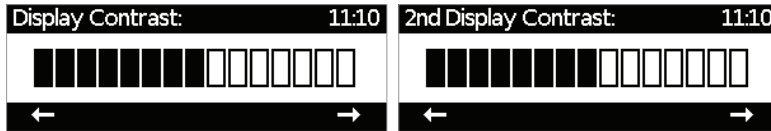



Fig. 5

Fig. 6

5. Press the right or left arrow on the navigation key or the function key underneath the right or left arrow in the function key line to increase (▶) or decrease (◀) the contrast.
6. When done, press  to save and return to the **Display** menu (Fig. 2).

### Adjusting font size on the phone's function key display

The font size for the function key labels on the second display (function key screens) is adjustable.



1. Press .
2. Press **1 Preferences** (see Fig. 1 on page 31)
3. Press **5 Display**.
4. Press **3 Font Size 2nd Display**.
5. Use the alphanumeric keypad to enter the font size (Fig. 7). If you need to delete the character to the left of the cursor, press the function key underneath .
6. Press  to save the setting and to return to the **Display** menu (Fig. 2).



Fig. 7

### Adjusting display settings for connected D7s

The intensity of the displays' backlight and the font size of the function key labels is adjusted separately for the phone and the connected D7 expansion modules. Lowering backlight intensity lowers the energy consumption of the devices. You can also set how the labels of the keys are presented on the display, i.e., as lines or as tiles .

**Note:** The number of seconds after which the D7 expansion modules will switch from activity to idle backlight is the number set for the phone display's backlight (see "Adjusting backlight and contrast on the phone's displays" on page 31).

- **Appearance.** This setting determines whether the data is presented in tiles or lines. It is adjusted separately for each module, i.e, the first D7 in the daisy-chain is listed as no. "1", the second one as no. "2", and the third one as no. "3". For more information on the module's display layout, refer to the user manual at [http://wiki.snom.com/Snom\\_D7/Documentation](http://wiki.snom.com/Snom_D7/Documentation).

1. Press .
2. Press **1 Preferences** (see Fig. 1 on page 31).
3. Press **5 Display**.
4. Press **6 Expansion Modules**.

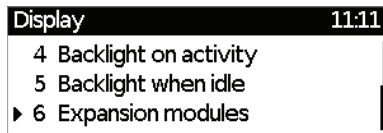

Fig. 8

5. Press **1 Appearance**.

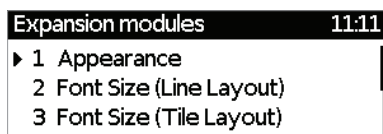





Fig. 9



Fig. 10



Fig. 11

6. Press 1, 2, or 3 to change and simultaneously save the display layout of the first, second, or third connected D7 expansion module, respectively, from lines to tiles and vice versa (Fig. 10 and 11), or scroll to the respective setting and press .
7. Press  to return to the **Expansion modules** menu (Fig. 9); press  for approx. 3 seconds to return to the idle screen.

- **Font size.** As of FW version 8.9.3, it is possible to adjust the font size for the connected expansion modules. The size is set separately for line and tile layout, and the respective setting is applied to all connected modules with line or tile layout, respectively.





1. Press .
2. Press **1 Preferences** (see Fig. 1 on page 31).
3. Press **5 Display**.
4. Press **6 Expansion Modules**.
5. Press **2** or **3** to select the font size setting for line or tile layout, respectively (Fig. 9).
6. Use the alphanumeric keypad to enter the font size (Fig. 12 and 13). Press the function key underneath  to delete the character to the left of the cursor.
7. Press  to save the setting and to return to the **Expansion modules** menu (Fig. 9).















Fig. 12



Fig. 13

- **Intensity of backlight.** The setting is applied to all D7 expansion modules connected to the phone.
  1. Press .
  2. Press **1 Preferences** (see Fig. 1 on page 31).
  3. Press **5 Display**.

4. Press **6 Expansion Modules**. Alternatively, scroll down to **6 Expansion Modules** and press .
  5. Press **4 Backlight on activity** or **5 Backlight when idle** (or 2 or 3, respectively, depending on FW version), or use the up/down arrows   on the navigation key to scroll to the item.
  6. Press the right or left arrow on the navigation key or the function key underneath the right or left arrow in the function key line (see illustrations on page 31, Fig. 3 and 4) to increase () or decrease () the backlight's intensity.
  7. When done, press  to save and return to the **Expansion modules** menu (Fig. 9).
- **Period of inactivity.** The setting for the phone is also applied to all connected D7 modules. See "Adjusting backlight and contrast on the phone's displays" on page 31.
  - **Contrast.** The setting is applied to all D7 expansion modules connected to the phone.
    1. Press .
    2. Press **1 Preferences**.
    3. Press **5 Display** (Fig. 8).
    4. Press **6 Expansion Modules**. Alternatively, scroll down to **6 Expansion Modules** and press .
    5. Press **6** (or **4**) **Contrast** or scroll down to it and press  (Fig. 11).
    6. Press the right or left arrow on the navigation key or the function key underneath the right or left arrow in the function key line to increase () or decrease () the contrast (see illustration on page 32, Fig. 5).
    7. When done, press  to save and return to the **Expansion modules** menu (Fig. 9).

## The phone's web interface

Opening the web interface: See page 36.

### Firmware versions below 8.7.4

When the web interface is opened for the first time upon initialization, you will see the **Security** page.

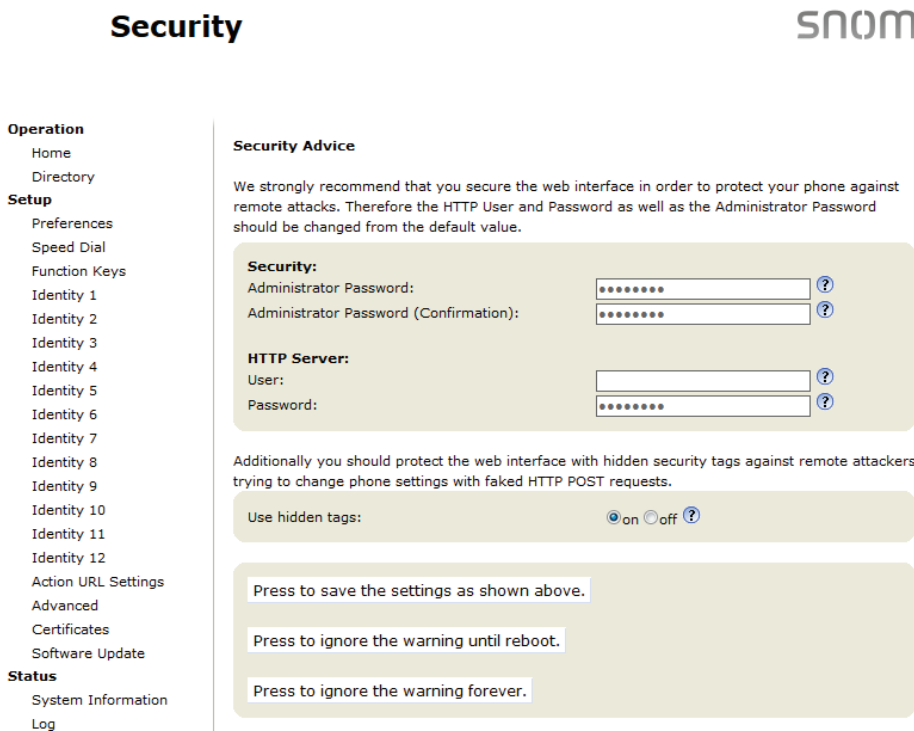

**Security** SNOM

**Operation**  
Home  
Directory

**Setup**  
Preferences  
Speed Dial  
Function Keys  
Identity 1  
Identity 2  
Identity 3  
Identity 4  
Identity 5  
Identity 6  
Identity 7  
Identity 8  
Identity 9  
Identity 10  
Identity 11  
Identity 12  
Action URL Settings  
Advanced  
Certificates  
Software Update

**Status**  
System Information  
Log

**Security Advice**

We strongly recommend that you secure the web interface in order to protect your phone against remote attacks. Therefore the HTTP User and Password as well as the Administrator Password should be changed from the default value.

**Security:**  
Administrator Password:  ?  
Administrator Password (Confirmation):  ?

**HTTP Server:**  
User:  ?  
Password:  ?

Additionally you should protect the web interface with hidden security tags against remote attackers trying to change phone settings with faked HTTP POST requests.

Use hidden tags:  on  off ?

Press to save the settings as shown above.  
Press to ignore the warning until reboot.  
Press to ignore the warning forever.

We urge you to set administrator and HTTP passwords to protect your phone from remote attacks. The default administrator password is 0000 (4 zeros); there is no default HTTP password. **Please note:**

- If you do not replace the default administrator password by an individual one, an unauthorized third party with access to the phone could set an administrator password unknown to you. In such a case, you would no longer be able to switch from user mode to administrator mode.
- If you do not set an HTTP password, you make it easier for experienced hackers to break into your system.
- If you set your own passwords, be sure to write them down and store them in a secure place.

Without the administrator password, you will not be able to return the phone and the web interface from user mode to administrator mode; many settings will be inaccessible.

Without HTTP password you cannot open the phone's web interface.

If you do not wish to set an HTTP password, you can turn off the reminder on the phone's display until the next reboot or forever by clicking on the respective button. If you change your mind later, you can set a password on the phone's web interface, **Advanced Settings** page > **QoS Security** tab > **HTTP Server** section or turn off the warning later on the **Advanced Settings** page > **QoS Security** tab > **Security** section > "Ignore security advices".

### Firmware versions 8.7.4 and higher

When you register the first account during the initialization of the phone, your SIP user name and password will be registered as the HTTP user name and password. If you wish to change them later, you can do so on the phone's web interface > **Advanced Settings** page > **QoS Security** tab > **HTTP Server** section.



**Note:**

- If you do not replace the default administrator password by an individual one, an unauthorized third party with access to the phone could set an administrator password unknown to you. In such a case, you would no longer be able to switch from user mode to administrator mode.
- If you set your own passwords, be sure to write them down and store them in a secure place.

Without the administrator password, you will not be able to return the phone and the web interface from user mode to administrator mode; many settings will be inaccessible.

Without the HTTP password you cannot open the phone's web interface.

### Opening the web interface

1. Look up the phone's IP address: Press  if available, or  > **6 Information** > **2 System Info** or **3 Help**.
2. Open a web browser on your PC. Enter the IP address, preceded by "http://" or "https://" in the address bar (for example: http://192.168.10.115) and press ENTER. The home screen opens:

**Welcome to Your Phone!**

**Operation**

- Home
- Directory

**Setup**

- Preferences
- Speed Dial
- Function Keys
- Identity 1
- Identity 2
- Identity 3
- Identity 4
- Identity 5
- Identity 6
- Identity 7
- Identity 8
- Identity 9
- Identity 10
- Identity 11
- Identity 12
- Action URL Settings
- Advanced
- Certificates
- Software Update

**Status**

- System Information
- Log
- SIP Trace
- DNS Cache
- Subscriptions
- PCAP Trace
- Memory
- Settings

**Manual**

This web interface makes it easy for you to set your phone up correctly and to access the advanced features.

To dial a number, just enter the number in the field below. You can enter a simple telephone number (e.g. 0114930398330) or URI like info@snom.com.

**Dial a Number:**

 Dial Hangup

**Outgoing Identity:**

7899@ .snom.com Set

[Dialed, Missed, Received](#)

**Dialed Numbers** ✕

Date	Time	Duration	Costs	Local Identity	Number	
19.10.2015	11:33	00:00:32		173	159	✕
					159	✕
16.10.2015	15:31	00:00:00		7899	159	✕
					159	✕
15.10.2015	12:07	00:00:00		7899	156 Adam Smith	✕
15.10.2015	11:15	00:00:12		7899	157	✕
					157	✕
15.10.2015	11:14	00:00:00		7899	7881	✕
					7881	✕

**Missed Calls** ✕

Date	Time	Missed	Local Identity	Number	
19.10.2015	11:38	1	172	157	✕
				157	✕
19.10.2015	10:13	1	7899	159	✕
				159	✕
15.10.2015	12:24	1	173	157	✕
				157	✕
13.10.2015	15:50	1	7899	157	✕
				157	✕

**Received Calls** ✕



## How the web interface works

The vertical menu on the left side of the window is always the same, no matter which window happens to be open at the time. Available menu items depend on whether the phone is running in user or administrator mode.

Click on a menu item to open that page. Some pages contain several documents. To make a document visible, click on its tab. The font weight of the characters on the active tab is **bold**. Only one tab can be active at a time.

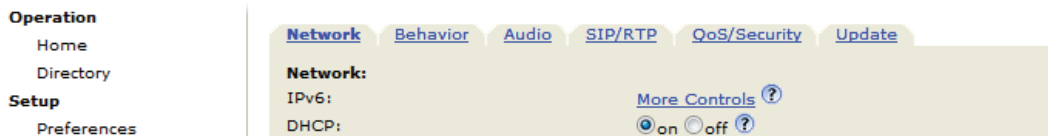

**Note:** Any changes you make will not take effect until you click on "Apply". Changes will be lost if you open another page of the web interface or if you close the web interface without first clicking on "Apply".

After you have clicked on "Apply", in some cases the "Save" button will appear at the top of the page. Click on "Save" to save the changes permanently. Changes that have not been saved will be lost if and when the phone loses power or is disconnected from its power source.

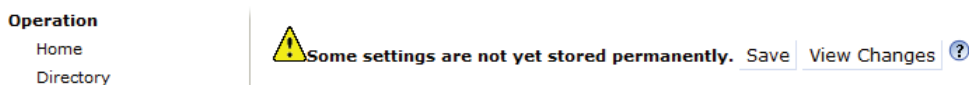

To the right of each setting, there is a link symbolized by the question mark . Click on this link to open a wiki page with information on the setting (description, valid and default value, links to connected issues, etc.). Click on the return button of your browser to return to the phone's web interface.

**Note:** You may have to enter your HTTP password to return to the phone's web interface.

## Web settings overriding manual phone settings

In some cases settings activated on the web interface override manual settings on the phone. If a setting you have made on the phone does not appear to take effect, look for a conflicting setting on the web interface or check with your administrator.

## User mode/administrator mode

Snom phones can be operated in administrator or user mode. In administrator mode, all settings are accessible and can be modified; in user mode, a number of settings are not accessible. The factory default is administrator mode.



When the phone is running in user mode, the administrator password is required to switch to administrator mode. The default administrator password is 0000 (4 x zero). We recommend that you change the password for security reasons.

**Note:** Do not forget to write the new password down and store it in a safe place; without it, a TFTP reset to factory values is necessary to return the phone to administrator mode.

If your phone is administered centrally, user mode may be the rule. Please check with your administrator.

### User mode on the phone

The "Network" menu and various other settings are inaccessible in user mode. See "Settings" on page 28. To switch to admin mode, proceed as follow:

1. Press .
2. Press **4 Maintenance**.
3. Press **1 Security**.
4. Press **1 Administrator Mode**.
5. Enter the **Admin Mode Password**.
6. Press  to save and return to **Security** menu.
7. Press  for two seconds to return to the idle screen.

### User mode on the web interface

Some windows like **Preferences** are available in user mode while many others, like the identities, are not. The menu item **Advanced** is available in user mode but the settings normally found on the **Advanced Settings** page are not. In user mode the two pages look like this:

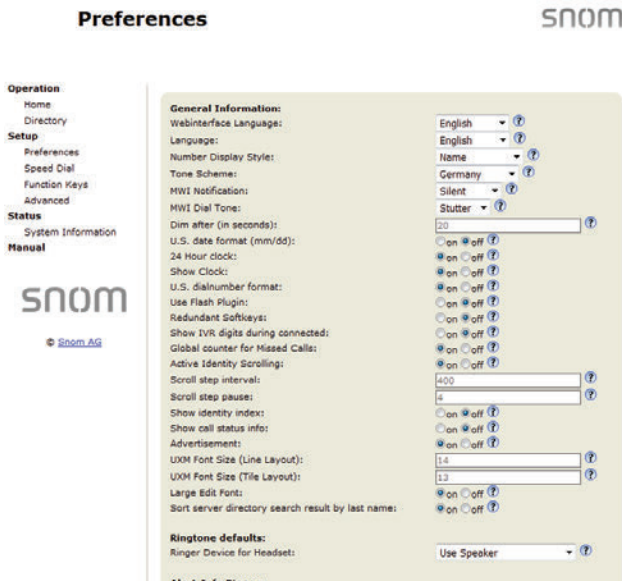

Fig. 1

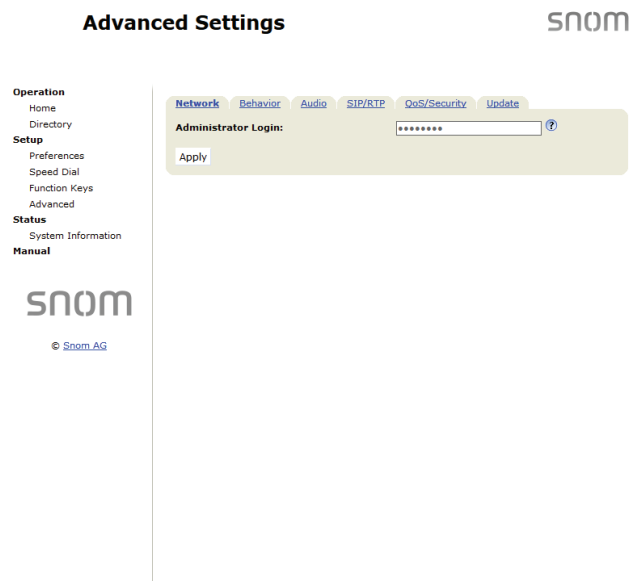

Fig. 2

To return the phone and its web interface to administrator mode, open the **Advanced Settings** page, enter the administrator password in **Administrator Login** and click on "Apply" (Fig. 2). The default password is 0000 (4 x zero). In administrator mode, the two pages look like this:

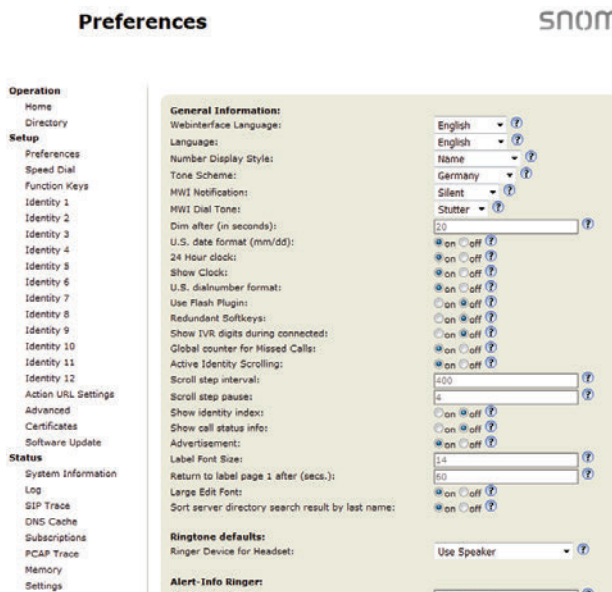

Fig. 3

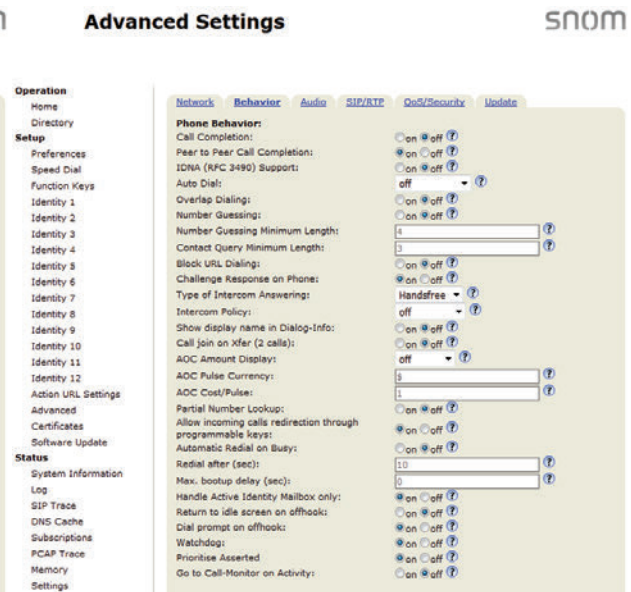

Fig. 4

# Directories

## Directory

The directory is the built-in directory of the phone. It can hold up to 1000 entries. Entries can be added and edited on the phone and on the web interface.

? Directory					
Name:	Number:	Contact Type:	Outgoing Identity:	Edit	Delete
Jane Smith	9175554128	None	Active		
John Miller					
- fixed	9175554230	None	Active		
- private	9175557018	None	Active		
- cell	9175554231	None	Active		

Any changes you make on the web interface will not take effect until you click on "Save" or on "Apply" and "Save", depending on your firmware version. Changes will be lost if you open another page of the web interface without first clicking on "Apply"/"Save".

## Definitions, explanations

### Directory entries

Each entry must have at least one phone number; multiple associated phone numbers are possible. If you do not enter a first and/or last name and/or nickname, the phone number will appear under both "Name" and "Number".

- Entry with one phone number:

Jane Smith	9175554128	None	Active			
------------	------------	------	--------	--	--	--

- Entry with several associated phone numbers:

John Miller						
- fixed	9175554230	None	Active			
- private	9175557018	VIP	Active			
- cell	9175554231	None	Active			

**Number area (N):** Individual settings for the master record and each subentry possible.

**Blue area.** Data can be different for each associated phone number. If subentry textfields are blank, the data from the master record is displayed.

**Name area.** Same data for the master record and all subentries.

Master record (M)

? Add or Edit Entry:	
Number:	4442090
Number Type:	<b>N</b> sip
Contact Type:	VIP
Outgoing Identity:	Active
Group:	Work
Title:	Manager
Organization:	Smith
Email:	<b>M</b> jd@smithjones.com
Note:	
Photo:	
Nick Name:	
First Name:	Jane
Family Name:	Doe
Birthday:	<b>M</b> 14.3.
Favorite:	<input type="checkbox"/>

Subentry 1

? Add or Edit Entry:	
Number:	4442091
Number Type:	<b>N</b> cell
Contact Type:	VIP
Outgoing Identity:	Active
Group:	Work
Title:	Manager
Organization:	Smith
Email:	<b>M</b> jd@smithjones.com
Note:	
Photo:	
Nick Name:	
First Name:	Jane
Family Name:	Doe
Birthday:	<b>M</b> 14.3.
Favorite:	<input type="checkbox"/>

Subentry 2

? Add or Edit Entry:	
Number:	555557815
Number Type:	<b>N</b> private
Contact Type:	VIP
Outgoing Identity:	555557815@ser.i
Group:	<b>S</b> Friends
Title:	<b>M</b> Manager
Organization:	<b>M</b> Smith
Email:	<b>S</b> jane.d@madetup.cc
Note:	
Photo:	
Nick Name:	
First Name:	Jane
Family Name:	Doe
Birthday:	<b>M</b> 14.3.
Favorite:	<input type="checkbox"/>

Blue area of Subentry 2: Different "Group" selection (S), different entry in textfield of "Email" (S). No entry in text fields of "Title" and "Organization", therefore same as Master Record.

## Contact Types

**VIP:** Calls from numbers with this contact type will ring on your phone even when DND mode is active. You can assign a ringtone to this contact type. If your VIP is also assigned to a group (see below) and if that group has a distinct ringtone, the ringtone assigned to the group will be played.

**Deny List:** Calls from phone numbers with this contact type will not ring on your phone. The caller hears the "Busy" signal. To remove the number from the Deny list, you can either

- delete the entry from the directory by clicking on the "delete" symbol 
- or - if you want to keep the number in the directory - change the contact type to none or VIP by editing the entry. See "Editing existing entry" on page 43 (editing on the phone) and "Editing an entry" on page 44 (editing on the web interface) for more information.

## Outgoing identity

The default setting is "Active" which means that the phone will use the current outgoing identity whenever you dial the number of the phone book entry.

You can also select a specific identity to be used as the outgoing identity whenever the number is dialed, for example, if you want to use a specific VoIP provider for these calls.

**Note:** To use an outgoing identity specified in the directory, you must dial the number from the directory. If you simply type it on the keypad, the current outgoing identity, as indicated on the display, will be used.

## Group

The available group types are **Friends, Family, Work, Colleagues**, or **None**. The default setting is none. You can assign a distinct ringtone to each group type.

## Ringtones

The phone has 10 built-in ringtones that can be assigned to identities, group types, and contact types. It is also possible to download a custom melody.

Assigning ringtones to identities: See "Assigning ringtones" on page 75.





### Assigning ringtones to contact type VIP and group types

1. Open the phone's web interface, **Preferences** page, **Directory Ringtones** section.
2. Select a ringtone from the respective drop-down menu and click on "Apply". If you choose "Custom Melody URL", enter the URL to the data file in the text field. It must be a file of the type PCM 8 kHz 16 bit/sample (linear) mono WAV.

**Note:** Ringers assigned to contact type VIP and to any of the group types override the ringers assigned to the identities. For example, if you have assigned ringer 1 to one of the identities and ringer 2 to the group "Colleagues", the phone will play ringer 2 when a contact from the "Colleagues" group calls that identity.

## Adding/Editing Entries on the Phone

### Adding new entry manually









1. Press  to open the phone's directory.
2. Press  on the navigation key to go straight to <New Item>.
3. Press .
4. Enter the phone number and press .
5. Enter a nickname in the text field of "nick name" (optional) and/or press . The **Details** screen opens.

**Note:** Entering a nickname is optional. If you don't enter one, the entry will be listed under the phone number. You can add a first and last name later by editing the entry on the phone or on the web interface.

6. See "Editing existing entry" on page 43 on how to continue.

### Adding new entry from call list

For further information on call lists, see "Call lists" on page 59.





1. Press  to open Call History, then 1, 2, or 3 to open the list of missed, received, or dialed calls, respectively.  
Alternatively, press  (dialed calls),  (received calls), or  (missed calls) to open the respective call list.
2. Use / to select a call.
3. Press  to view call **Details**.
4. Press  to add the name (if the name was transmitted) and number to the phone directory. If the name has not been transmitted, the number will be used in its place.

See "Editing existing entry" on page 43 on how to add a name, phone type, group, etc.





### Adding current caller

Press  to add the caller's name (if transmitted) and phone number to the directory. If the name has not been transmitted, the number will be used in its place. See "Editing existing entry" on page 43 on how to add a name, phone type, group, etc.









### Sorting entries

1. Press  to open the phone's directory.
2. Press .
3. Use / to select the criterion for sorting (nickname, first name, last name, organization, etc.) and press  to sort.

### Editing existing entry





1. Press  to open the phone's directory.
2. Selecting an entry: Scroll to the entry or enter the first letter of the name.
3. Press . The **Details** screen for the entry will be displayed.
4. Editing a detail.
  - a. Press  and  to select a detail. Depending on the detail,
  - b. In some cases, you will see the prompt screen where you can enter or modify text. Edit the data, if necessary, and press  to save and to open the next screen. See also "Entering numerals, letters, special characters, and symbols" on page 25.

In other cases, you will see a succession of screens with context-sensitive buttons. Example: Modifying the settings of "group".

- i. Select "group" with  and . The **favorite** screen opens.
  - ii. Use  and  to select yes or no. The **group** screen opens.
  - iii. Use  and  to select family, friend, colleague, work, or none. The **contact type** screen opens.
  - iv. Use  and  to select VIP, block, or none.
- c. When you are done editing the entry, press .

### Deleting an entry

1. Press  to open the phone's directory.
2. Selecting an entry: Scroll to the entry or enter the first letter of the name.
 

**Note:** If there is more than one phone number associated with the entry and you want to delete only one of them, press . Select the number you want to delete with  and press .
3. Press . You will be asked, "Are you sure?".
4. If you are, press .

## Adding/editing entries on the web interface

Click on **Directory** in the menu on the left side.

### Adding new entry

1. Type data in text fields of **Add or Edit Entry**.
  - Number: Type the number exactly as you would dial it, with country and area codes, if necessary, and without parentheses, hyphens, blank spaces. plenty
  - Number Type: Select the type of connection from the drop-down menu. The default setting is SIP.

- **Contact Type:** Select "None", "VIP", or "Deny" from the drop-down list. The default setting is "None".
  - Calls from entries on the "VIP" list will always ring on the phone, even when the phone is in a call or in DND mode.
 

**Note:** You can assign a distinct ringtone to the contact type "VIP": **Preferences** page > **Directory Ringtones** section.
  - Calls from entries on the "Deny" list will not ring on the phone. The caller will always hear the busy signal.
- **Outgoing Identity:** The drop-down list shows all identities configured on the phone. If you select one of the identities for one of the numbers listed in the phone book, all calls to that number initiated from the phone book will show that identity on the callee's phone.
- **Blue area:** The data entered in the textfields will be displayed when the entry is opened on the phone. The data can be used to sort entries by group, name, organization, etc., and can be edited on the phone.
  - "Group" drop-down menu: Available types are "Friends", "Family", "Colleagues", or "Work". You can assign a distinct ringtone to each group type: Preferences > Directory Ringtones.
  - "Nickname": If you enter a nickname, it will appear under the "Name" header of the **Directory** on the web interface.
- **First name, family (last) name:** Will be added in this order under "Name" in the directory, unless you have also entered a nickname.
- **Birthday.** Uses the format set at **Preferences > General information > U.S. Date Format** (mm/dd): "On" or "Off". Enter in DD.MM.YR or MM/DD/YR format. Examples:

Date	Input	Output when <b>US Date Format</b> setting is	
		On	Off
March 5, 1980	5.3.80 or 3/5/1980	03/05/80	05.03.80
March 12, 1980	12.3.80 or 3/12/1980	03/12/80	12.03.80
October 5, 1980	5.10.80 or 10/5/1980	10/05/80	05.10.80
October 12, 1980	12.10.80 or 10/12/1980	10/12/80	12.10.80

- **Favorite:** Tick box to add entry to "Favorites" list.

2. Click on "Add/Edit" to save new entry to directory.

**Editing an entry**



When you open an existing entry, the current information is displayed in the text fields of "Add or Edit Entry" and two additional buttons, "Add Sub" and "Change", are available (see Fig. 2 and 3, below).

- Editing

Name:	Number:	Contact Type:	Outgoing Identity:	Edit	Delete
Jane Smith	9175554128	None	Active		
John Miller					
- fixed	9175554230	None	Active		
- private	9175557018	VIP	Active		

Fig. 1



- If single entry, click on  in the entry's line.
- If there is more than one number associated with a name:
  - Click on  in the name's line if you want to edit/add the first or last name of the date of birth and the data in the blue area applicable to the master record.
  - Click on  in a phone number's line if you want to edit the subentry's data (phone number, number & contact type, outgoing identity, and any blue area data applicable to this subentry only).

Make changes as necessary and click on "Change".

- Adding additional phone number (subentry) for a name
  - Jane Smith's entry has only one phone number, her SIP phone number. In this example, the phone number of Jane Smith's landline will be added to the directory.
    - Click on  in Jane Smith's line (Fig. 1, above). The data is shown in "Add or Edit" area (Fig. 2).

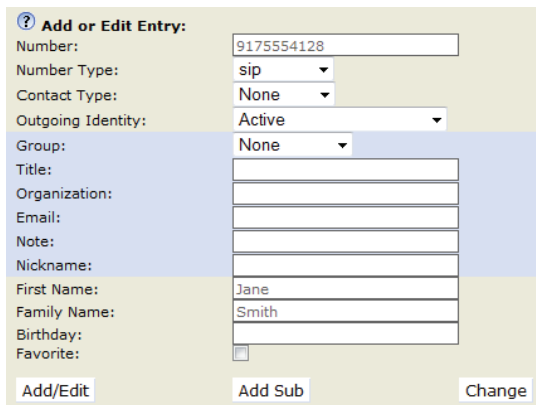

**Add or Edit Entry:**

Number:

Number Type:

Contact Type:

Outgoing Identity:

Group:

Title:

Organization:

Email:

Note:

Nickname:

First Name:

Family Name:

Birthday:

Favorite:

Fig. 2

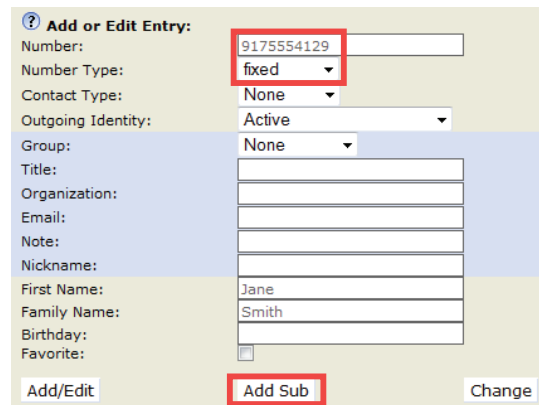

**Add or Edit Entry:**

Number:

Number Type:

Contact Type:

Outgoing Identity:

Group:

Title:

Organization:

Email:

Note:

Nickname:

First Name:

Family Name:

Birthday:

Favorite:

Fig. 3

- Enter the phone number in the text field of "Number" (Fig. 3).
- Select "fixed" from the drop-down menu of "Number type" (Fig. 3).
- Optional: Select a contact type and an outgoing identity from drop-down lists (Fig. 3).
- Click on "Add Sub" (Fig. 3).
- John Miller's entry has a SIP number and a private number. In this example, his cell phone number will be added as a third number.
  - Click on  in the line containing John Miller's name. The data is shown in "Add or Edit" area.
  - Enter the phone number in the text field of "Number".
  - Select the number type.
  - Optional: Select a contact type and an outgoing identity from the respective drop-down list.
  - Click on "Add Sub".

The directory now contains Jane Smith's landline number and John Miller's mobile phone number (Fig. 4).

Name:	Number:	Contact Type:	Outgoing Identity:	Edit	Delete
Jane Smith					
- sip	9175554128	None	Active		
- fixed	9175554129	None	Active		
John Miller					
- fixed	9175554230	None	Active		
- private	9175557018	VIP	Active		
- cell	9175554231	None	Active		

Fig. 4

### Deleting entry on web interface

- Entry with one phone number. Click on in the entry's lines to delete the entry.
- Entry with more than one phone number.
  - Deleting the entry. Click on in the line of the master record to delete the name and all associated phone numbers.
  - Deleting one of the phone numbers. Click on in the line of a phone number subentry to delete that subentry, but keeping the master record and all other subentries.

### Dialing from phone directory

To dial, click on the phone symbol on the right side of the line with the phone number.

### Deleting whole directory

Deletes the entire directory irretrievably!

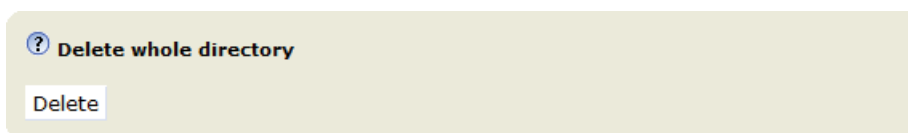

### Importing/Exporting Directory

See our Wiki at [http://wiki.snom.com/Web\\_Interface/V8/Directory](http://wiki.snom.com/Web_Interface/V8/Directory).

## External directories

Available if provided by your network, your VoIP provider, or another external source.

### LDAP

Enter the necessary data received from your administrator, VoIP provider or other external source in the text fields of the phone's web interface > **Advanced Settings** page > **Network** tab > **LDAP** section and click on "Apply" and "Save".

LDAP search on the phone: Enter the first letter of the name you are searching for. Type more letters if the name shown isn't the right one or scroll through the list. Press  to dial.

### Contacts

If you want to use an external contacts list, the **Contact list** and **Contact list URI** settings are mandatory. **Publish presence** is optional; when enabled, the phone sends out "PUBLISH" SIP messages with the phone's status, e.g. busy, etc.

1. On the phone's web interface, **Configuration Identity #** page, **SIP** tab, click on the radio button **on** of the **Contact list** entry.
2. Enter the URI received from your administrator, VoIP provider or other external source in the text field of **Contact list URI**.
3. Optional: Click on the radio button **on** of the **Publish presence** setting.
4. Click on **Apply** and **Save**.

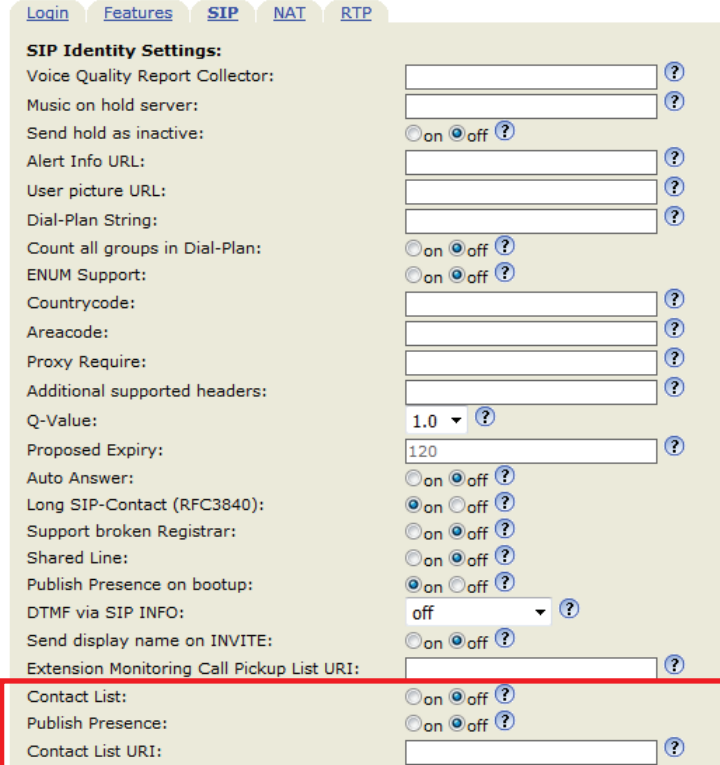

The screenshot shows the 'SIP Identity Settings' page with tabs for Login, Features, SIP, NAT, and RTP. The 'SIP' tab is active. The 'Contact List' section is highlighted with a red box and contains the following settings:

- Contact List:  on  off ?
- Publish Presence:  on  off ?
- Contact List URI:  ?

To dial a contact on the phone, enter the first letter of the name you are searching for. Type more letters if the name shown isn't the right one, or scroll through the list. Press  to dial.

## Using the phone

This section describes the functions of the phone with the factory default settings. If your phone was installed and/or set up by someone else, the default settings may have been changed. Please check with that person or company if the phone does not react as described here.

The caller information displayed on the screen is controlled by a setting on the phone's web interface. The default setting is "Name". You can change the setting at **Preferences > General Information > "Number Display Style"** by selecting a different option from the drop-down list.

## Making calls

See "Entering numerals, letters, special characters, and symbols" on page 25 for information on input modes and entering letters, numerals, and special characters.

### Selecting identity for current outgoing call

See "Identities/accounts" on page 73 on how to configure identities.

If more than one identity is shown on the display, the one with the black phone symbol  and the arrow is the outgoing identity for the call and the number/name that will show on the callee's phone. Use the up or down arrow on the navigation key to select another identity.

## Using different audio devices

### Handset

- Pick up the handset, enter the phone number, and press  OR
- enter the phone number and pick up the handset.

### Headset



Press  to activate headset mode, enter the phone number, and press .

### Speakerphone

Enter the phone number and press  or .

### Handset or headset and casing speaker

With dual audio mode activated, other persons present in the room are allowed to listen in to the third party over the phone's casing loudspeaker.

1. Use the method for handset or headset use to dial.
2. When the call has been established, press  to enable the casing loudspeaker. Press  to turn the speaker off.



## Using different dialing methods

### Auto dial



**Note:** The default setting is off. In admin mode, the setting can be enabled on the **Advanced Settings** page, **Behavior** tab, **Phone Behavior** section, **Auto Dial** setting by selecting a time span in seconds from the drop-down menu.

When the setting is enabled, the phone will dial the number on the display when the specified number of seconds has elapsed since the last digit was typed.



### Redialing

1. Press  to show the last numbers dialed, with the very last number at the top.
2. Press  to dial that number or use ▲ / ▼ to select a different number and then press .

### Calling number from call history (missed, received, dialed calls)

1. Press  (dialed calls), ► (received calls), or ◀ (missed calls) to open the respective call list.
2. Use ▲/▼ to select a call.
3. Press  to dial the number.

### Calling number from phone directory

1. Press  to open the phone's directory.
2. Use ▲ / ▼ to select a name or enter the first letter(s) of the name on the alphanumeric keypad.
3. Press  to dial the number.

### Calling number from external directory

1. Open the dial screen to get access to the external directory:
  - a. Lift the handset off the cradle or press the speakerphone key to open the dialing screen (Fig. 1).
  - b. Press  to show the list of available directories and call lists.
  - c. Select the external directory, in our example LDAP (Fig. 2).



Fig. 1

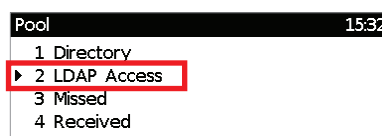



Fig. 2

2. Use ▲ / ▼ to select a name or enter the first letter(s) of the name on the alphanumeric keypad.
3. Press  to dial the number.

## Speed dialing

Setting speed dial numbers: See "Speed dial" on page 84. Mapping a speed dial number onto one of the freely programmable function keys: See "Configuring the function keys", "Example 3, Speed dialing" on page 71.

- Speed dial number on speed dial list
  1. Enter the speed dial number (0-30) or character (#, \*) assigned to the phone number you wish to dial.
  2. Press  to dial.
- Speed dial number mapped onto freely programmable function key 1-12: Press the key.

## Calling emergency numbers

Numbers specified as emergency numbers can be dialled even when the keyboard is locked. See "Emergency numbers" on page 79 on how to set emergency numbers. Several numbers (911, 112, 110, 999) have been preconfigured.

- On an unlocked keyboard: Enter the number and press  to dial.
- On a locked keyboard: Enter the number. The phone dials the number as soon as you have entered all the digits of one of the programmed emergency numbers.

## Call completion

**Note:** This function depends on whether it is available in your network or not. On Snom phones call completion means that when a called number is busy or not available, you can have your phone call you back as soon as the dialed number is not busy anymore or available again. The factory default setting is "off".

Changing the setting to turn on call completion : See "Call completion" on page 81.



When call completion is enabled, the symbol  will appear in the function key line whenever you dial a number (Fig. 1). Press the key underneath  to activate call completion for this call.



Fig. 1



Fig. 2



Fig. 3





- Press  /  to turn off call completion for this call (Fig. 2).
- Press  /  if you wish to dial another number while waiting for call completion (Fig. 2). You can now hang up the handset to return to the idle screen (Fig. 3); use handset, headset, or speakerphone to dial another number (Fig. 4); receive calls etc. Call completion will not interfere with the normal operation of your phone.



Fig. 4

When the number becomes available, you will see it announced on the display (Fig. 5) and hear a double beep if you are in a call.

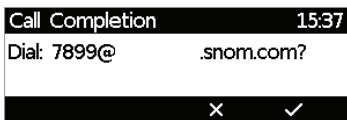







Fig. 5

- Press  /  to dial.
- Press  /  to turn off call completion for this call.

### Number guessing (auto completion)

**Note:** The default setting for Number guessing is "off". To be able to use it, open the phone's web interface to the **Advanced Settings** page > **Behavior** tab > **Phone Behavior** section, change the setting to "on", and enter the minimum number of characters that must be entered before number guessing will start.

When number guessing is enabled, the phone will propose numbers containing the typed string from the numbers saved on its call lists and in the directory as soon as you have typed the minimum number of digits. If and when the desired number is on the display, press  to dial.

In the following example, the minimum number of characters is four:

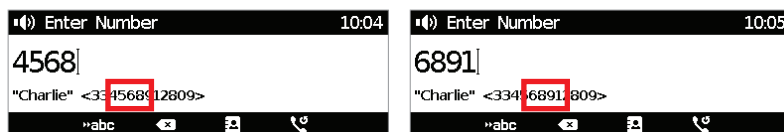



## Accepting calls

### Using different audio devices

**Handset:** Pick up the handset.

**Headset:** Press . If the phone is already in headset mode, you can also press the blinking line key.

**Speakerphone:** Press  or  or the blinking line key.

## Automatically accepting calls

The default is "off". Turning the function on: On the phone's web interface > **Configuration Identity #** > **SIP** tab > "Auto answer": Click on the radio button **on**.

With this setting, your phone will automatically accept incoming calls when it is idle:

- If you are using Firmware version 8.7.2 and higher, calls will be accepted on speakerphone; press the headset key  if you want them to go to the headset.
- Firmware version 8.7.1 and lower: Open the phone's web interface to the **Preferences** page > **Auto Answer** section > "Type of Answering" and select **Handsfree** (speakerphone) or **Headset** from the drop-down menu.

If you want to be alerted acoustically by a single long beep, whenever the phone accepts an incoming call, you need to change another default setting on the phone's web interface from **off** to **on**: **Preferences** > **Auto Answer** > "Auto Answer Indication".

## Call pick-up from another extension

You can pick up calls ringing on another extension, for example when the other extension is busy or when the user is absent. The prerequisites for this function are as follows:

- It must be supported by the PBX.
- The extensions whose calls you want to pick up on your own extension must permit this function. It is possible but not required to restrict the permission for monitoring to certain users or groups of users.

Settings: See "Configuring the function keys", "Example 1, Extension monitoring and call pick-up" on page 69.

- Each extension to be monitored must be programmed onto one of the freely programmable function keys with LEDs on the phone or a connected D7 Expansion Module. See chapter "Configuring the function keys", "Example 1, Extension monitoring and call pick-up" on page 69 and "Example 2, Extension monitoring and call pick-up on D7 expansion module" on page 70.
- If you want to see who is calling or connected to any of your monitored extensions, you need to enable the function "Go to call monitor on activity": Phone's web interface > **Advanced Settings** page > **Behavior** tab > "Go to call-monitor on activity:" **on**.

When these prerequisites are met, the status of the monitored extension is indicated by the LED of the function key:

- Blinking LED: Incoming call ringing. If the call is not answered, press the key to pick it up;
- LED glowing steadily: The monitored extension is busy (in call, dialing, etc.);

and by the idle display showing the call-monitor state:

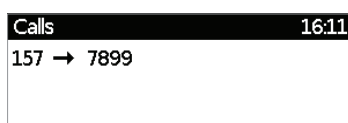

Fig. 1

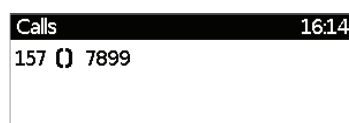



Fig. 2



- When your phone is idle, any ongoing activity on all extensions monitored by your phone will be shown on the display. In the above examples, extension 7899 is a monitored extension. "157 → 7899" (Fig. 1) indicates that extension 157 is calling extension 7899; "157 ☎ 7899" (Fig. 2) indicates that 7899 is connected to 157 and that 157 is the caller, 7899 the callee.
- Press  to close the **Calls** screen and return to the idle screen.

## Call waiting

When you are in a call, another call coming in will be announced visually by the flashing call LED and by the symbol  appearing in the function key line (Fig. 1); it will also be announced acoustically by a double beep. If you want to switch to visual or acoustic announcement only or turn call waiting off completely, see "Call waiting" on page 82.



Fig. 1



Fig. 2



Fig. 3

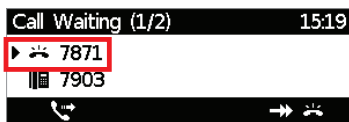











Fig. 4



Fig. 5

When a call is waiting, you have the following options:

- Press the blinking line key of the call waiting to put your current call on hold and to accept the second call without knowing who is calling (Fig. 3). This option is available only when there is a free line key available at the time the call comes in.
  - Press the function key underneath  (Fig. 1) to put the **Call waiting** screen on the display (Fig. 2); you will see the caller ID on-screen if it is being transmitted.
    - Press  to reject the call waiting. The caller will hear the busy signal.
    - Press  to accept the second call and put your current call on hold.
    - Press  to return to the **Connected** screen with your current connection.
- Note:** Pressing  and  will affect the call shown on the display, i.e., your current connection in Fig. 1 and 3 or the call waiting in Fig. 2, 4, and 5.
- If there is more than one call waiting (Fig. 4 and 5), press the keys  and , respectively, to bring them on-screen and to return to the connected call.
  - If you do not wish to accept the waiting call, you can:
    - ignore the announcement. If you have set call forwarding when busy, the call will be transferred to that phone.
    - reject the incoming call by putting the **Call waiting** screen on the display and pressing . The caller hears the busy signal. Pressing  for three seconds will also put the caller on the

"Deny" list of the phone's directory. Future calls from this number will not ring on the phone; the caller hears the busy signal. For more information on the "Deny" list and how to remove entries from it, see "Contact Types" on page 41.

## Active calls

### Hold

#### One call on hold

Press  to put the ongoing call on hold. Held calls are indicated threefold:

- By the text on the display.



- By the slowly blinking line key.
- By the slowly blinking call indication LED.

You can now:

- transfer the held call blindly or with prior announcement - see "Transferring calls" on page 56.
- receive and make calls and put other calls on hold.

Pick up the held call by pressing its line key or by pressing  again. If the other party hangs up while on hold, the call is terminated on your phone as well and the LED indicators are turned off.

#### Holding multiple calls

If you are in a call with one party and have one or more calls on hold or if there is more than one call on hold, the symbol  is available in the function key line. You can switch back and forth between the active call and any call on hold. Up to 12 simultaneous calls are possible, if supported by the PBX.





- In Fig. 1 and 2 the phone is in one active call with a second call on hold. Press the function key underneath  /  to show the call not currently on screen.
- In Fig. 3, 4, and 5 there is one active call, and two calls are on hold. Press the function key underneath  to show the calls not currently on screen, one after the other.



Fig. 1

Fig. 2

Active call indicated by the symbol , followed by the phone number of the other party (Fig. 1).

Held call indicated by the symbol , followed by the phone number of the party on hold (Fig. 2, 3, 4, and 5).



Fig. 3



Fig. 4



Fig. 5

- When the connected call is on-screen, you can transfer it to a third party or terminate it by pressing
- When a held call is on-screen, press

## Conference

The maximum number of participants is three.

### Initiating a conference

1. Call the first intended participant and put him or her on hold.
2. Call the second intended participant and put him or her on hold.



Fig. 1

3. Press

### Conference screen navigation

Your input on the phone's keys will affect the caller/callee(s) or the entire conference shown in the contact area of the display.

**Example:** A conference with three participants, including yourself. After you have pressed (Fig. 1) to start the conference, the names, if available, or phone numbers of the other participants are shown on-screen (Fig. 2 - 4).



Fig. 2









Fig. 3



Fig. 4

- Selecting individual participants. Press the up or down arrows / on the navigation key to select one of the participants or the conference. The selected item is indicated by the arrow preceding the symbol indicating the conference or one of the participants, respectively:

- Conference
- 157
- 7899

- Talking to one participant in private. With one of the participants on-screen selected by the preceding arrow ► (Fig. 3 and 4), press  to converse with that participant in private and to put the other party on hold.  
To restart the conference, press  to put the connected party on hold again, then press .
- Putting one participant on hold. With one of the participants on-screen selected by the preceding arrow ► (Fig. 3 and 4), press  to put this party on hold and to converse with the other party in private.  
To restart the conference, press  to put the connected party on hold again, then press .
- To terminate the conference and the connections to both parties, select the conference (Fig. 2) and press .

## Transferring calls

You can transfer connected calls as well as calls ringing on your phone.

- When you have a call on the line, there are two ways to transfer it to a third party:
  - Announcing the call to the third party first, to make sure the call is welcome and will be accepted: Attended transfer;
  - Transferring the call unannounced: Blind transfer. There will be no feedback on whether the third party is available and/or picking up the call.
- When a call is ringing on your phone, you can transfer it to a third party without answering it first (blind transfer only).

### Attended transfer

1. Put the call on hold.
2. Dial the number you want to transfer the call to and announce the call (Fig. 1).
3. If the third party wants to accept the call, press .



Fig. 1



Fig. 2



Fig. 3

**NOTE:** If there is more than one call on hold and the call you want to transfer is not on-screen, press  (Fig. 4) to put it on-screen (Fig. 5 and 6).



Fig. 4



Fig. 5

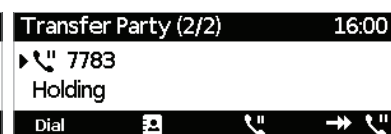

Fig. 6

- With the **Transfer Party** screen on the display (Fig. 2 or, if more than one call is on hold, Fig. 5 or 6), press . You will briefly see the "disconnected" screen. If there's another call on hold, you will then see the holding screen (Fig. 7).



Fig. 7

### Blind transfer

- Blind transfer of active call**

- With a call on the line (Fig. 1), press or the function key underneath . The dial screen will appear (Fig. 2).



Fig. 1



Fig. 2



Fig. 3



Fig. 4



Fig. 5



Fig. 6

To transfer your active call while a call is waiting (Fig. 4), as indicated by the symbol in the lower right corner, also press . The "Transfer party" screen appears on the display (Fig. 5). Pressing any number key will open the dial screen (Fig. 6).

**Note:** If you want to transfer the call waiting, see "Blind transfer of call waiting", below.

- Dial the number of the third party to whom you intend to transfer the call or press the function key underneath to select a number from one of the available directories and call lists (Fig. 2 and 6).
- Press . The transferred call is briefly indicated as "disconnected" (Fig. 3) before the ringing call is shown on the display.

- Blind transfer of ringing call**

- With a call ringing (Fig. 1), press or the function key underneath .



Fig. 1



Fig. 2

- Dial the number of the third party you intend to transfer the call to (Fig. 2).

3. Press .

- **Blind transfer of call waiting**

For more information on call waiting, see .

1. If you are in a call and want to transfer a call waiting (Fig. 1), press  to put the call waiting on-screen (Fig. 2).

**NOTE:** Your active call will remain active while you are transferring the ringing call.



Fig. 1

Fig. 2



Fig. 3

2. Press .

3. Dial the number of the third party you intend to transfer the call to (Fig. 3).

4. Press .

## Terminating calls

- When using the handset: Place the handset in the cradle or press .
- When using speakerphone or a headset: Press .

## Missed Calls

Missed calls are indicated by the call LED (steady light) and by the text "Missed:" and the number of missed calls in the status line (Fig. 1) and/or on the Status info screen (Fig. 2 or 3, respectively, depending on whether or not there are other status messages).



**Note:** If there are status messages with a higher priority, the status line will show the message with the highest priority.





Fig. 1

Fig. 2

Fig. 3

- To view your missed calls, press the right arrow  on the navigation key or the function key underneath . To view details of the calls on the list, see "Call lists", next page.
- Turning off the missed call indications (LED and "Missed" message). Use one of the following methods:

- View the list of missed calls.
- Via the **Status info** screen.
  1. Press , if available (Fig. 1), or open the **Settings** menu  > **6 Information** > **1 Status Info** to view the status info messages.
  2. Press the function key underneath  to delete the "Missed" message line (Fig. 2). If there are other status info messages, you may need to use the up/down arrows on the navigation key to select the "Missed" message line (Fig. 3).



**Note:** This will only remove the status message "missed" and turn off the LED. The missed calls lists will not be deleted.



## Call lists

Three call lists of missed, dialed, and received calls are stored on the phone. They contain the number, time and date, and duration of the calls. If the memory allotted to storing the call lists is full, the oldest ones will be overwritten.

1. Press  to open Call history.
2. To view the list of missed, received, or dialed calls, press its number (Fig. 1 - 3).

**NOTE:** If  has been replaced with another function, you can also use the following keys to view the lists (default setting):

- Missed calls: Press the right arrow  on the navigation key.
- Received calls: Press the left arrow  on the navigation key.
- Dialed calls: Press .

3. On each list, the latest call is at the top of the list (Fig. 4 - 6). Scroll through the list with the up/down arrows / on the navigation key.

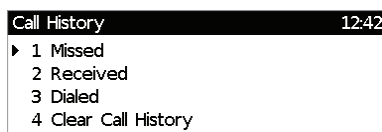

Fig. 1

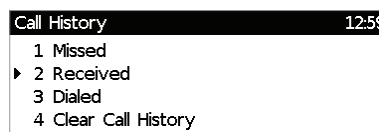

Fig. 2

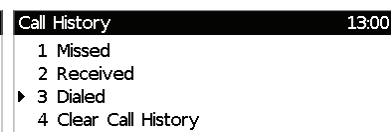

Fig. 3



Fig. 4



Fig. 5



Fig. 6





Fig. 7











Fig. 8



Fig. 9

- Press  to dial the number of the selected call indicated by the arrow  preceding the call.





- Press  to delete the selected call indicated by the arrow  preceding it.
- Press  to delete the entire list.
- Press  to return to idle screen.
- Press  to show the call details of the selected call.
  - Missed calls: To, from, time (and date if not today), total number of missed calls from caller.
  - Received and dialed calls: To, from, time (and date if not today), duration of call.
- When viewing the Details of a call (Fig. 7 - 9):
  - Press  to edit.
  - Press  to add the caller/callee to the phone's directory. See "Editing existing entry" on page 43 for information on adding a name and other data to the new directory entry.
  - Press  to delete the call.

## Rejecting or redirecting incoming calls

This includes manual and automatic rejection and redirection and automatic rejection of anonymous calls.

### Manually

If you do not wish to pick up a ringing call, you have three options: Letting the call ring and not picking it up, rejecting it manually, or transferring it manually to a third party.

- Rejecting a ringing call manually.
  - Press . The caller will hear the busy signal.
  - Press  for two seconds to reject the call and additionally place the caller on the "Deny" list of the phone's directory so that calls from that number will never ring on your phone; the caller will always hear the busy signal. For more information on the "Deny" list and how to edit or remove entries from it, see "Contact Types" on page 41.
- Transferring the ringing call to another phone (blind transfer).
  1. Press .
  2. Enter the number you want to transfer the incoming call to.
  3. Press  to complete the transfer. The incoming call will continue ringing at that number.

### Automatically



There are four options for rejecting incoming calls automatically or to have them forwarded automatically, either always or under certain conditions:

- Deny List. Calls from phone numbers on this list will not ring on your phone; callers will hear the busy signal. For further information, see "Contact Types" on page 41.



- DND - do not disturb mode. All incoming calls will be forwarded to the number set in call forwarding when busy; if there is no setting for call forwarding, callers will hear the busy signal.

**Exception:** Phone numbers designated VIP in your phone's directory will ring on your phone even when DND is on.

1. Press  to activate DND.
  2. Press  again to deactivate DND.
- Call forwarding. For further information, see "Call forwarding" on page 62 and 79.
  - Rejecting anonymous calls: See next section.

## Rejecting anonymous calls

With this setting you can have your phone reject calls from phones that are blocking or not transmitting their numbers.

**Please note:** Calls from analog phone connections without caller ID will, most likely, be received as anonymous calls. They will be rejected when you turn this function on.

### Activating rejection of anonymous calls

1. Press .
2. Press **2 Call Features**.
3. Press **3 Incoming Calls**. The empty box  of the setting "Reject anonymous" (Fig. 1) indicates that the function is inactive.
4. Press **1** to activate the function. When it is activated, i.e., anonymous callers are being rejected, the box is checked  (Fig. 2).

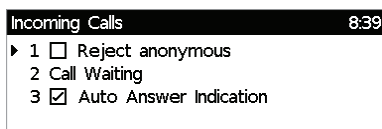

Fig. 1

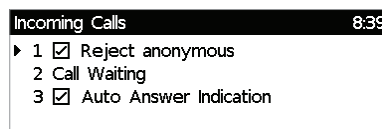





Fig. 2

5. Press  for two seconds to return to the idle screen.

### Deactivating rejection of anonymous calls

1. Press .
2. Press **2 Call Features**.
3. Press **3 Incoming Calls**. The box with the checkmark  of the setting "Reject anonymous" (Fig. 2) indicates that the function is active.
4. Press **1** to deactivate the function. The checkmark is removed from the box , indicating that the function is now inactive (Fig. 1).
5. Press  for two seconds to return to the idle screen.

## Call forwarding

The phone can be set to forward incoming calls, either always or under certain conditions. The settings can be done on the phone and on the web interface. For further information on using the web interface for these settings, see "Call forwarding" on page 79.



**NOTE:** Call forwarding is set for each configured identity separately. When the setting is done on the phone, it applies to the identity selected as outgoing identity.

**Forward All:** Forwarding all incoming calls to the number of the phone, extension, or mailbox specified as this function's target.



Forwarding all calls is off























All incoming calls are forwarded

In the default setting, one of the symbols  /  is available in the function key line and can be used to turn forwarding of all calls on and off, respectively, by pressing the function key underneath the symbol, but you can also map the function onto another function key or use the settings menu as shown in the table below.

**Forward when Busy:** Forwarding calls ringing while the phone is busy to the number of the phone, extension, or mailbox specified as this function's target.

**Forward after Timeout:** When a call starts ringing, the phone will wait for the number of seconds specified in the setting "Call forwarding time". If the call is not accepted by the end of this time period, it is forwarded to the number of the phone, extension, or mailbox specified as this function's target.

### Making/changing the settings on the phone and turning on call forwarding

	Forward all	Forward when busy	Forward after timeout
Press			
Press	 2 Call Features	 2 Call Features	 2 Call Features
Press	 1 Call Forwarding	 1 Call Forwarding	 1 Call Forwarding
Press	 1 Forward All	 2 Forward when Busy	 3 Forward after Timeout
Press	 2 Target when forwarding	 2 Target when forwarding	 2 Target when forwarding
Type	phone number	phone number	phone number
Press			
Press			 3 Call Forwarding time
Type			number of seconds
Press			
Press	 1 <input type="checkbox"/> Activate	 1 <input type="checkbox"/> Activate	 1 <input type="checkbox"/> Activate

The setting will change to "1  Activate", indicating that call forwarding is now active. Press  for two seconds to return to the idle screen.

The status line and the status info screen will indicate that call forwarding is turned on and the number incoming calls will be forwarded to.



Fig. 1

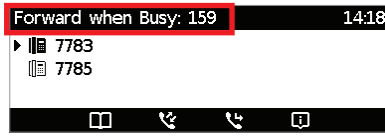



Fig. 2



Fig. 3

**Note:** Call forwarding is indicated in the status line, which can display only one message at a time; forwarding of all calls (Fig. 1) is also indicated by the symbols on the display.

When "Forward when busy" (Fig. 2) and "Forward after timeout" (Fig. 3) are both activated, "Forward when busy" is shown in the status line. If there are other status messages with a higher priority than call forwarding (e.g., firmware update available, reboot required, etc.), they will take precedence over the call forwarding indication.

Press  to show the **Status info** screen (Fig. 4) with all current status messages, including call forwarding. When the symbol is not available on the display, you can access **Status info** from the **Settings** menu:

1. Press .
2. Press **6 Information**.
3. Press **1 Status info**.

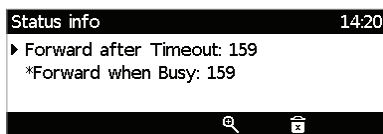

















Fig. 4

## Turning off call forwarding

	Forward all	Forward when busy	Forward after timeout
Press			
Press	 2 Call Features	 2 Call Features	 2 Call Features
Press	 1 Call Forwarding	 1 Call Forwarding	 1 Call Forwarding
Press	 1 Forward All	 2 Forward when Busy	 3 Forward after Timeout
Press	 1 <input checked="" type="checkbox"/> Activate	 1 <input checked="" type="checkbox"/> Activate	 1 <input checked="" type="checkbox"/> Activate

The menu item changes to "1  Activate". Press  for two seconds to return to the idle screen.



## Turning forwarding of all calls on/off with a function key

### Turning call forwarding on

**NOTE:** Call forwarding is set for each configured identity separately. When the setting is done on the phone, it applies to the identity selected as outgoing identity.

1. Press . The display will show the **Target when Forwarding** screen.

**Note:** If the function key  is not available when the display is in idle mode, you can make it available on the **Function Keys** page of the phone's web interface. For further information see "Configuring the function keys", "Example 4, Changing setting of context-sensitive key" on page 72. Default settings: See "At a glance" on page 18.

2. If no forwarding number has been set or if it needs to be changed, make the necessary entries.
3. Press . The symbol is now crossed off: .

### Turning call forwarding off

Press the function key underneath .

# Configuring the function keys

See page 36 on how to open the phone's web interface. See 37 on the mechanics of navigating in the windows and changing the settings.

Any changes you make will not take effect until you press "Apply" and "Save". Changes will be lost if you open another page of the web interface without first pressing "Apply"/"Save".

## Function keys on Snom phones

Every phone has a limited number of hard keys. Phone users, however, have a myriad of different priorities and preferences when asked which functions they use most often and which functionalities they would like to access quickly. Snom has therefore designed the function keys to be programmable, even the preprogrammed "hard keys" whose default function is printed on them.

There are four types of programmable function keys (see also "At a glance" on page 18):

- Context-sensitive, programmable function keys. For the default settings, see "At a glance" on page 66. You can select a different key event to be available on each respective key when the phone is in idle mode.

You cannot change the functions that are available when the phone is active, for example when you are in a call, when the phone is ringing, etc. Depending on the activity, different functions will be available.

See "Appendix 1 - Display Symbols and Icons" on page 66 for the lists of symbols and their description.

- Navigation, confirmation, and cancel keys. For the default settings, see "At a glance" on page 18. You can select a different key event to be available on each respective key when the phone is in idle mode.

You cannot change the functions that are available when the phone is active, for example when you are in a call, when the phone is ringing, etc.

- Dedicated, customizable function keys. The default setting is the respective key event printed onto the key. Other key events and a selected number of other functionalities can be programmed onto them.

- Freely programmable function keys on the phone and on connected expansion modules. All available functionalities, including key events, can be programmed onto them.

When an expansion module is connected to the phone, its function keys are added to the **Function Keys** page of the web user interface of the phone (see "Function key page of phone's web interface" on page 23, Fig. 4 and 5).

**Note:** For information on connecting the D7 expansion module, please refer to the user manual at [http://wiki.snom.com/Snom\\_D7/Documentation](http://wiki.snom.com/Snom_D7/Documentation). The user manual also contains specific information on the D7's configuration.

The settings of the function keys on the expansion modules are stored on the phone and, unless deleted prior to the module's disconnection, remain available to be used when the same or any

other module of the same type is connected to the phone. They are not visible on the function keys page when no expansion module is connected.

- **Context**

This setting specifies which configured identity will be used when executing the functionality of the key. You may want to use this feature when you have accounts with different providers or when you wish to present different identities to certain destinations.

For example: If you have programmed key P2 to speed dial a specific number and you want to use configured identity 2 to call that number, select configured identity 2 from the drop-down menu of P2's "Context". When you speed dial the number by pressing key P2, identity 2 will be used as the outgoing identity.

The default setting is "Active", which means that the identity selected as the phone's outgoing identity at any given time will be used.

- **Type**

Select the type of functionality from the drop-down list. See "Appendix 4 - Programmable Functions" on page 94 for more information. If you select "Key Event", a drop-down list with the available key events will replace the text field under "Number". The default setting is "line".

- **Number**

Enter one phone number or value for the function or, if the function is key event, select an event from the drop-down list. Enter phone numbers exactly the way they need to be dialed, i.e, type the number without spaces or punctuation marks between the digits. For example, a number with an area code that might conventionally be notated as (916) 555-1234 should be entered as 9165551234.

- **Short Text**



Optional: Enter a name or other descriptive text in the text field. This is the data displayed on the key's label area on the phone's function key screen and on the D7's display, respectively. If you leave the field blank, the number will be displayed in the key label area.

## Programming the function keys

The freely programmable function keys on the phone and on all connected expansion modules can be mapped on the phone and on the phone's web interface. We recommend using the web interface which is faster and more comfortable.

### Settings on the phone

On the phone, a limited number of functionalities is available.

1. Press  > 1 Preferences > 6 Fkeys (Fig. 1).
2. Select **2**, **3**, **4**, or **5** to select **Line keys page 1**, **2**, **3**, or **4**, respectively, by pressing the corresponding menu number or by scrolling to the respective line keys page and pressing  (Fig. 2).
3. Select a key by typing its menu number on the keypad or by scrolling to it and pressing  (Fig. 3).
4. Select the functionality by typing its menu number on the keypad or by scrolling to it and pressing

 (Fig. 4).



- The information you will then be prompted to enter depends on the selected functionality. Enter it and press  (Fig. 5).
- You will then be prompted to enter a **Short Text**. This is the label that will be displayed on the function key screen. Enter the text and press  (Fig. 6). If you do not enter a text, the label area will display the **Number**.



Fig. 1

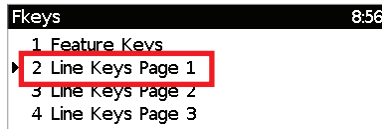

Fig. 2

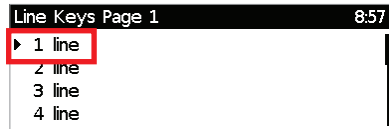

Fig. 3

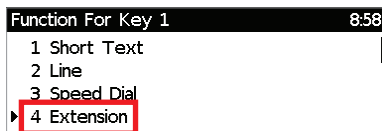

Fig. 4



Fig. 5



Fig. 6

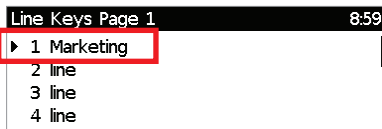

Fig. 7

Marketing	[free]	[free]	[free]
[free]	[free]	[free]	[free]

*Example setting: Page 1, key 1, functionality on key: extension, extension number: 7899, label text: Marketing*

## Settings on the web interface

- On the phone's web interface, click on **Function Keys** in the menu on the left.
- Under **Context** of the key, select "Active" or one of the configured identities from the drop-down list.
- Under **Type** of the key, select the functionality from the drop-down list.
- Depending on the selected functionality, there will be a text field or a drop-down menu in the **Number** column. Enter the number or select an item from the list.
- Optional: In the **Short Text** text field of the key, enter a name or descriptive text. This is the text that will be displayed in the key's label area on the phone's function key screen or on the D7's display. If the text field is empty, the label area will display the number.
- Click on **Apply** and **Save**.

## Selected examples for function key programming

This chapter will show you a few examples for customizing function key settings to your needs and preferences, using the phone's web interface:

- First example: Extension monitoring and call pickup via one of the phone's freely programmable and self-labeling function keys with LED
- Second example: Extension monitoring and call pickup via a function key on the D7 expansion module
- Third example: Speed dialing with a freely programmable function key with LED
- Fourth example: Changing setting of context-sensitive key



### Example 1, Extension monitoring and call pick-up

This feature makes it possible to pick up a call ringing on another extension registered at the same registrar, for example when the other extension is busy or when the user is absent. The prerequisites for this function are:

- It must be supported by the PBX.
- The extensions must permit this function. Setting: Phone's web interface > **Configuration Identity** (1-12) > **SIP** tab > "Allow incoming extension monitoring". The default is **on**.
- Restricting permission to groups of users by setting an ID: Phone's web interface > **Configuration Identity** (1-12) > **SIP** tab > "Extension monitoring group ID": Enter an ID (any character string) into the textfield.

**Note:** The first character of the ID must not be a '{' curly brace.

- The extension to be monitored must be programmed onto one of the freely programmable function keys with LEDs. In our example we are monitoring extension 7899 on key P1.

Context	Type	Number	Short Text	
Active	Extension	< sip:7899@example.snom.	Tom	P1
Active	Extension	< sip:7898@example.snom.		P2
Active	Extension	< sip:7895@example.snom.	Heidi	P3
Active	Speed Dial	6175550704	Boston Office	P4

1. On the phone's web interface, click on **Function Keys** in the menu on the left.
2. Under **Context** of P1, select "Active" or one of the configured identities from the drop-down list.
3. Under **Type** of P1, select "Extension" from the drop-down list.
4. In the **Number** text field of P1, enter the phone number whose calls you want to pick up. In our example it is 7899.
5. Optional: In the **Short Text** text field of P1, enter a name or descriptive text. In our example, it is "Tom". If the text field is empty, the label area will display the number.
6. Click on **Apply** and **Save**.

For an example of the extension setting on the phone, see the example setting on page 69, Fig. 1-7.

The LED of key P1 on the phone will now flash red quickly when a call is ringing on 7899 but only if page 1 is on-screen. If the call is not answered, you can pick it up by pressing key P1. When 7899 is engaged in a call, the key will glow red steadily.

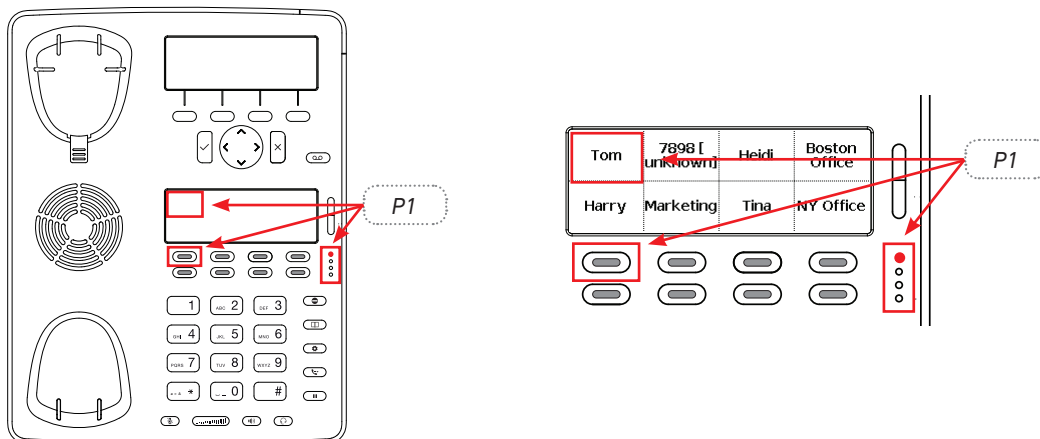

## Example 2, Extension monitoring and call pick-up on D7 expansion module

- All functions available on the freely programmable LED function keys of the phone are available on the connected D7.
- The prerequisites are the same as those for the LED function keys on the phone. See "Example 1, Extension monitoring and call pick-up" on page 70.
- For information on how to connect the D7 to the phone, as well as on D7 function key and display layout and settings, please see the D7 User Manual at [http://wiki.snom.com/Snom\\_D7/Documentation](http://wiki.snom.com/Snom_D7/Documentation).

Context	Type	Number	Short Text	
Expansion Module 1 line layout				
Active	Extension	<sip:157@example.snom.c	Tom	1
Active	Extension	<sip:167@example.snom.c		10
Active	Line			2
Active	Line			11
Active	Line			3
Active	Line			12
Active	Line			4
Active	Line			13
Active	Line			5
Active	Line			14
Active	Line			6
Active	Line			15
Active	Line			7
Active	Line			16
Active	Line			8
Active	Line			17
Active	Line			9
Active	Line			18

Tom
167 [idle]
[free]
[free]
[free]
[free]
[free]
[free]
[free]
[free]
[free]
[free]
[free]
[free]
[free]
[free]
[free]

1. On the phone's web interface, click on **Function Keys** in the menu on the left.
2. Under **Context** of the key on the expansion module, select "Active" or one of the configured identities from the drop-down list.
3. Under **Type**, select "Extension" from the drop-down list.
4. In the **Number** text field, enter the phone number whose calls you want to pick up. In our example it is extension 157 on key 1 and extension 167 on key 10 (the left and right top keys on the D7).
5. Optional: In the **Short Text** text field, enter a name or descriptive text. If you leave the field blank, the number will be displayed in the key's label area on the D7's display.
6. Click on **Apply** and **Save**.

The LED of the key on the D7 will now flash red quickly when a call is ringing on the extension. If the call is not answered, you can pick it up by pressing the key. When the extension is engaged in a call, the key will glow red steadily.

### Example 3, Speed dialing

Besides using the **Speed Dial** page on the web interface to program speed dial numbers, you can also put the functionality on the freely programmable function keys with LEDs on the phone or a connected expansion module. In our example, key P4 on page 1 of the function keys will be used to speed dial the number 6175550704.

Context	Type	Number	Short Text	
Active	Extension	< sip:7899@example.snom.	Tom	P1
Active	Extension	< sip:7898@example.snom.		P2
Active	Extension	< sip:7895@example.snom.	Heidi	P3
Active	Speed Dial	6175550704	Boston Office	P4

1. On the phone's web interface, click on **Function Keys** in the menu on the left.
2. Under **Context** of P4, select "Active" or one of the configured identities from the drop-down list.
3. Under **Type** of P4, select "Speed Dial" from the drop-down list.
4. In the **Number** text field of P4, enter the phone number that you want to be able to speed dial. In our example it is phone number 555-0704 in area code 617.

Type each phone number with any necessary area code and/or country code etc. without spaces, hyphens, etc. Example: In conventional notation you might write the number as (917) 555-0184. Type 6175550704 into the text field.

5. Optional: In the **Short Text** text field, enter a name or other descriptive text. If the text field is empty, the label area will display the number.
6. Click on **Apply** and **Save**.

You can now speed dial the number 6175550704 by pressing key P4 on the phone.

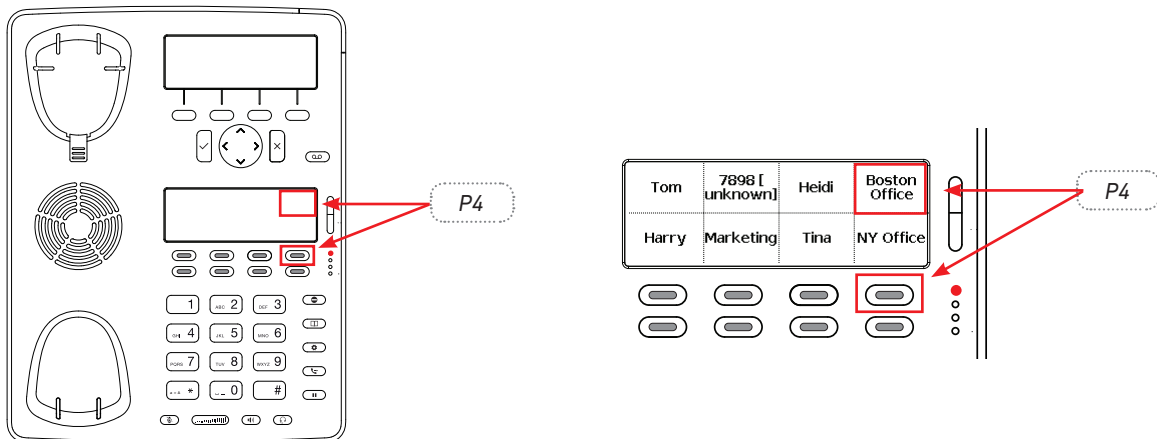

## Example 4, Changing setting of context-sensitive key

You can select a different key event to be available on the four keys under the display when the phone is in idle mode. You cannot change the functions that are available when the phone is active, for example when you are in a call, when the phone is ringing, etc. In the following example, the setting of the left key will be changed from **Directory** to **LDAP Directory**.

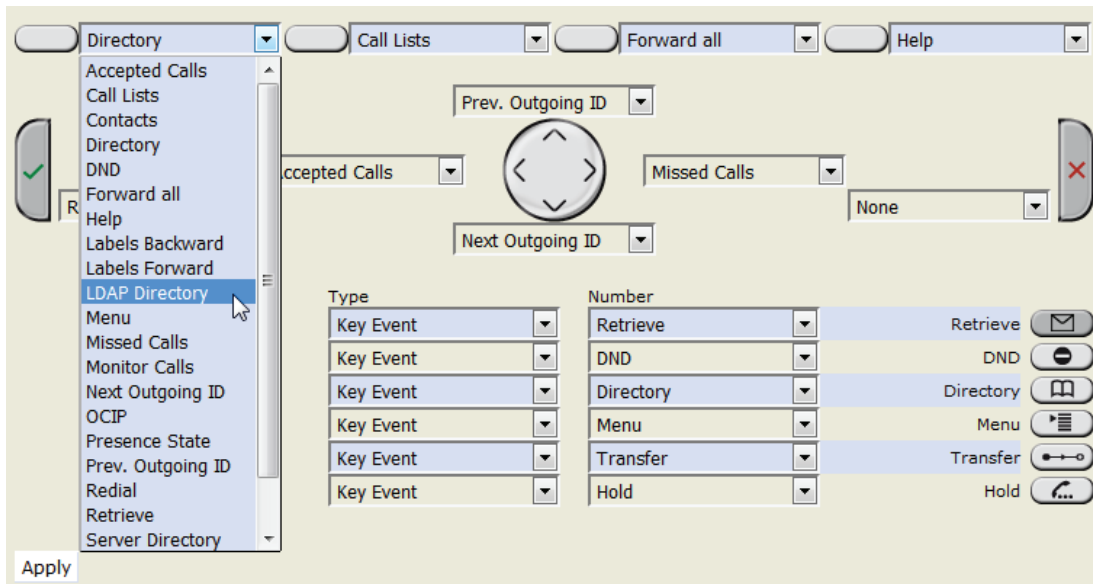

1. On the phone's web interface, click on **Function Keys** in the menu on the left.
2. Click on the drop-down list of the left key under the display.
3. Select "LDAP Directory" from the drop-down list.
4. Click on **Apply** and **Save**.

By pressing the context-sensitive function key you now have direct access to your LDAP directory, if available and the settings are provided on the phone's **Advanced Settings** page > **Network** tab > **LDAP** section.

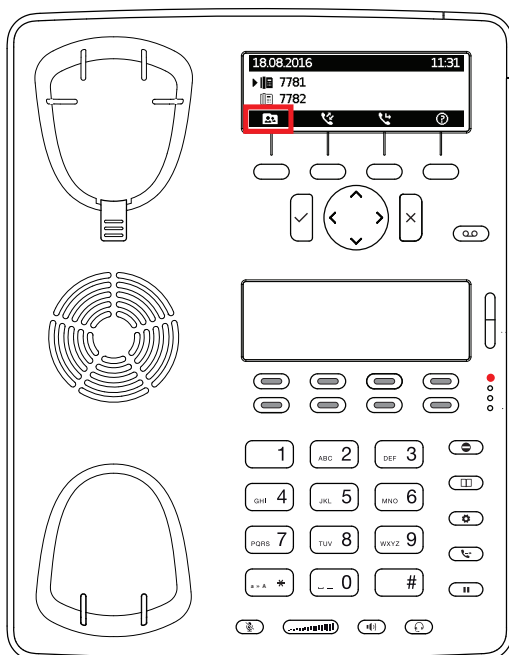

# Customizing the phone settings

See "The phone's web interface" on page 35 on how to open the phone's web interface, how the web interface works, and how to change the settings. See "User mode/administrator mode" on page 38 on the difference between administrator and user mode.

If you have access to administrator mode, but do not consider yourself to be an expert on SIP and SIP phones, we recommend that you do not change any of the technical settings since this may adversely affect the phone's performance or put it out of order altogether.

If you want more information on a web interface setting, click on the radio button with the question mark  that you see to the right of each item. It links to a page on Snom's Wiki with detailed information about that particular item.

On customizing the function key settings, see the chapter "Configuring the function keys" on page 65.

**Note:** Any changes you make on the web interface will not take effect until you click on "Apply" and "Save". Changes will be lost if you open another page or tab of the web interface or if you close the web interface without first clicking on "Apply" and "Save".

## Identities/accounts

The phone supports up to four accounts or "phone numbers" with one or more providers or within an office or organization network. On Snom phones these accounts or phone numbers are called "identities".



**Note:** If your phone is part of an office network, you may need to contact your administrator to configure new or change existing identities, as this can only be done when the phone is running in administrator mode and when the PBX settings allow it.

See "Initializing and registering the phone" on page 14 for more information on required input data.

## Configuring and editing identity/account

In admin mode only.

### On the phone

Press  > 3 Identity > 3 Edit User > 1 Hotdesking > select a free identity with ▼ and enter account and registrar. If you want or need to enter more data, use  > 3 Identity > 3 Edit User > 2 Edit User > select a free identity with ▼ or its number in the menu. Available menu items:

- 1 Active [Yes]
- 2 Displayname
- 3 Account**
- 4 Password

- 5 Registrar**
- 6 Outbound Proxy
- 7 Authentication User Name
- 8 Mailbox

## On the web interface

Open the web interface and click on an identity in the menu on the left. The configuration window for that identity will open; it contains four tabs, with the left one, Login, visible in the front. To view SIP, NAT, and RTP pages, click on the respective tab; the font weight of the tab on the active page is **bold**.

1. **Login tab.** Enter the information received from your provider or your administrator in the appropriate fields.

- Display name

The display name is optional and freely selectable. It will be sent to any parties you call unless you hide your identity (see "Hiding my caller ID" on page 82). If you do not enter a display name, the data in the "Account" text field will be shown on your display and sent to any parties you call unless you hide your identity.

- Display text for idle screen

Any text you enter in in this text field will be shown - instead of your display name or account - on your display only. It will not be sent to any parties you call.

- Ringtones

The phone has 10 built-in ringtones that can be assigned to identities, group types, and contact types. It is also possible to download a custom melody and to turn off the ringer by selecting "Silent".

See "Assigning ringtones" on page 75.

2. **SIP settings.** Click on the **SIP** tab to bring the page to the front. It contains a number of technical settings and textfields for entering URIs/URLs to various servers (for music-on-hold, for example), as well as some behavior settings. These are:

- Automatic acceptance of incoming calls: Auto Answer. The default setting is "off".

Acoustic alert (one short beep) when the phone accepts a call automatically: Preferences > Auto Answer > Auto Answer Indication. The default setting is "off".

- Contact List. A contact list must be available on a server. Click "on" and enter the Contact List URI .

- Identity can receive calls. The default setting is "on". The default setting is "on". If you want to be able to use the identity for outgoing calls but do not wish other phones to be able to call the identity, turn the setting off.

- Allow incoming extension monitoring. If you do not want other phones to be able to monitor the activity on your phone, turn the setting off.

You can also allow only certain phones to monitor and pick up your calls. In this case, select the "On" setting and enter a password into the next field of the next setting, "Extension monitoring group ID" . **The password cannot start with a "{" bracket.**

Any phone allowed to monitor and pick up your calls must also use the same password in this text field.

**Note:** If you want the activity on the monitored phones to be displayed on your idle screen, enable the "Go to Call Monitor on Activity" on the **Advanced Settings** page > **Behavior** tab > **Phone Behavior** section.

3. If you have changed the account or the registrar, click on "Re-Register" and "Save". If you have made other changes, clicking on "Apply" and "Save" suffices (see "How the web interface works" on page 37).

## Assigning ringtones



The phone has 10 built-in ringtones that can be assigned to identities, group types, and the contact type "VIP". It is also possible to download a custom melody. When an incoming call to an identity is ringing, the phone will play the ringtone assigned to that identity, unless it is a call from a VIP or a group with a distinctive ringer of their own.

**Note:** Ringers assigned to the contact type VIP and to any of the group types override the ringers assigned to identities. For example, if you have assigned Ringer 1 to one of the identities and Ringer 2 to the group "Colleagues", the phone will play Ringer 2 when a contact from the "Colleagues" group calls that identity.

If your ringtones don't seem to work as expected, contact your administrator. There may be an overriding setting on the PBX.

**Assigning ringtones to contact type VIP and group types:** See "Ringtones" on page 41.

### Selecting identity ringtones:

- **On the phone:** 1 Preferences > 3 Ringer. If there is more than one configured identity on the phone, they are shown on the display.
  - Select an identity with ▲ / ▼ and press  to hear the current ringtone for that identity.
  - Selecting a different ringtone: Press ▲ / ▼ to navigate up and down the list of ringtones. The marked ringtone is played. Press  to save the marked ringtone as the new ringtone for the currently selected identity and return to the identity screen.
- **On the web interface** (the ringtones will be played by the phone): **Configuration Identity (1-12) > Login.**
  - Click on "Play Ringer" to play the currently selected ringer.
  - To change the ringer, select a ringer from 1 to 10 in the drop-down menu of "Ringtone". If you have selected the custom melody, enter the URL to the data file in the text field underneath. It must be a file of the type PCM 8 kHz 16 bit/sample (linear) mono WAV.
  - Click on "Apply" and "Save".

## Date and time formats

Date and time formats can be set on the phone and on the web interface. The defaults are US time format and 24-hour clock (Fig. 1 and 2). European date and time formats are shown in Fig. 3 and 4, US date and time formats in Fig. 5 and 6.

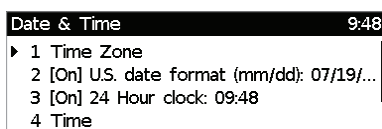

Fig. 1



Fig. 2

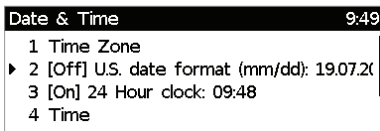

Fig. 3



Fig. 4

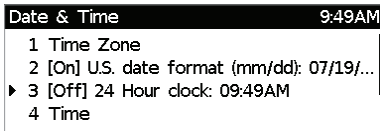

Fig. 5



Fig. 6

## Date

- Phone settings.
  1. Press > 1 Preferences > 1 Date & Time (see Fig. 1, above).
  2. In admin mode, press 2 (in user mode, press 1) to change U.S. date format from [On] to [Off] (Fig. 3). Alternative method: Scroll to "US date format" and press .
  3. Press briefly to return to the previous menu or for two seconds to return to the idle screen.
- Web interface settings.
  1. Open the **Preferences** page > **General Information** section > US Date Format. The default is "on".
    - Select "on" to have the date shown on the phone's display in "mm/dd/yyyy" format.
    - Select "off" to have the date shown on the phone's display in "dd.mm.yyyy" format.

Date	US Date Format	
	Setting "On"	Setting "Off"
March 5, 2012	03/05/2012	05.03.2012
March 12, 2012	03/12/2012	12.03.2012
December 5, 2011	12/05/2011	05.12.2011
December 10, 2011	12/10/2011	10.12.2011

2. Click on "Apply" and "Save".

## Time

The time setting affects phones and/or firmware versions with a digital clock only. If the phone has a clock face, changing the setting will not affect it.

- Phone settings.
  1. Press > 1 Preferences > 1 Date & Time (see Fig. 1, above).
  2. In admin mode, press 3 (in user mode, press 2) to change the 24-hour clock setting from [On] to [Off] (Fig. 5). Alternative method: Scroll to "24-hour clock" and press .



3. Press  briefly to return to the previous menu or for two seconds to return to the idle screen.
- Web interface settings.
    1. Open the **Preferences** page > **General Information** section > 24 Hour Clock. The default is "on".
      - Select "on" to have the time on the phone's display shown in 24-hour format, 00:01 to 24:00 .
      - Select "off" to have the time on the phone's display shown in AM/PM format, 0:01AM to 12:00PM.
    2. Click on "Apply" and "Save".

## Time zone

**Note:** The time zone setting is accessible in admin mode only.

You can change the time and date settings manually in admin and user mode, but the settings will be overwritten at the next reboot of the phone: (  ) > 1 Preferences > 1 Date & Time > 4 Time (3 in user mode) > 5 Date (4 in user mode)

The phone receives the time and date from your NTP time server. If the time and/or date on the display are incorrect, you may need to set the correct time zone. If you have set the correct time zone and the time is still incorrect, there may be a problem with the time server. Contact your network administrator or your IP provider.

The list of time zones is arranged by the difference in hours (+/-) to the UTC and, within each time zone, alphabetically by selected locations (country or country and city). Selecting and setting the time zone:

### On the phone

1. Press (  ) > 1 Preferences > 1 Date & Time > 1 Time Zone.

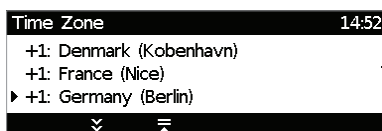

Fig. 1

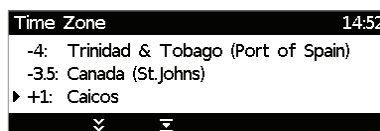







Fig. 2

- Press  to collapse the list to show only selected times zones and/or locations where the phone language is spoken. When the phone language is English, all time zones are shown (Fig. 1).
- When only selected time zones and/or locations are shown (Fig. 2), press  to show all.
- Press  to fast-forward to the beginning of the next time zone, i.e., UTC +1, +2, etc.
- Use ▲▼ to scroll.

2. Press  to save your selection
3. Press  briefly to return to the previous menu or for two seconds to return to the idle screen.

## On the web interface





1. Open the **Advanced Settings** page > **Network** tab > **Time** section > Timezone.
2. Select your timezone/country/city from the drop-down list.
3. Click on "Apply" and "Save".

## Language settings of phone and web interface

The language used on the phone can be changed on the phone as well as on the web interface. The language used on the web interface can be changed on the web interface only.

### Phone language

#### Setting on the phone

1. Press  > 1 Preferences > 4 Language.
2. Use   to scroll.
3. Press  to save the selected language.
4. Press  briefly to return to the previous menu or for two seconds to return to the idle screen.

#### Setting on the web interface

1. Open **Preferences** > **General Information** > Language.
2. Select the language from the drop-down list.
3. Click on "Apply" and "Save".





### Web interface language

1. Open **Preferences** > **General Information** > Web interface language.
2. Select the language from the drop-down list.
3. Click on "Apply" and "Save".

## Dial tones

Different dial tones for different countries! Select yours on the phone or on the web interface.

### Setting on the phone

1. Press  > 1 Preferences > 2 Tone Scheme.
2. Use   to scroll.
3. Press  to save the selected country.
4. Press  briefly to return to the previous menu or for two seconds to return to the idle screen.

### Setting on the Web Interface

1. Open **Preferences** page > **General Information** section > Tone Scheme.
2. Select the country from the drop-down list.
3. Click on "Apply" and "Save".

## Emergency numbers

These are numbers that can be dialed when the keyboard is locked. They must be set beforehand on the web interface. The numbers "911", "112", "110", and "999" are preset.

1. Open **Preferences** > **Lock Keyboard** section > Emergency Numbers (space separated).
2. Enter the emergency numbers in the text field. Type each number without spaces between the digits, separate the individual numbers with one empty space between them.  
  
Example: If you want to set the emergency phone number 911 and the phone numbers of your doctor (986543) and a friend (234578), the entry would look this: 911 986543 234578.
3. Click on "Apply" and "Save".

## Call forwarding

This feature automatically redirects all or certain incoming calls to another phone or a mailbox. If you set call forwarding on the phone, the settings are applied to all configured identities on the phone. On the web interface, the settings are configured separately for each identity.

### Always

All incoming calls are forwarded to the number of the phone, extension, or mailbox specified as this function's target.

### When busy

Calls ringing while the phone is busy are forwarded to the number of the phone, extension, or mailbox specified as this function's target.

## After timeout

When a call starts ringing, the phone will wait for the number of seconds specified as "call forwarding time". If the call has not been accepted by the end of this time period, it is forwarded to the number of the phone, extension, or mailbox specified as this function's target

When a call starts ringing, the phone will wait for the number of seconds specified as "call forwarding time". If the call has not been accepted by the end of this time period, it is forwarded to the number of the phone, extension, or mailbox specified as this function's target.

## Configuring the settings on the phone

See "Making/changing the settings on the phone and turning on call forwarding" on page 80 . The settings apply to all identities configured on the phone.

## Configuring the settings on the web interface

If your internet telephony provider or your PBX uses codes to turn functions on and off, refer to their manuals for the codes to enter in "On Code"/"Off Code" text fields or ask your administrator.

### Setting forwarding numbers

- Forwarding all incoming calls:
  1. Open **Configuration Identity** > **Features** tab > **Call Forwarding** > *Always*.
  2. Type the phone number in the "Target" text field. Type each number the way it needs to be dialed by the phone, without spaces or punctuation between the digits.
  3. Click on "Apply" and "Save".
- Forwarding incoming calls when the phone is busy:
  1. Open **Configuration Identity** > **Features** tab > **Call Forwarding** > *Busy* .
  2. Type the phone number in the "Target" text field. Type each number the way it needs to be dialed by the phone, without spaces or punctuation between the digits.
  3. Click on "Apply" and "Save".
- Forwarding incoming calls when they are not answered:
  1. Open **Configuration Identity** > **Features** tab > **Call Forwarding** > *Timeout*.
  2. Type the number of seconds into the text field of "Timeout (sec)". If an incoming call hasn't been answered when the time has elapsed, the call will be forwarded to the phone number entered as target.
  3. Type the phone number in the "Target" text field. Type each number the way it needs to be dialed by the phone, without spaces or punctuation between the digits.
  4. Click on "Apply" and "Save".

### Turning call forwarding on

1. Web interface > **Configuration Identity** > **Features** tab > **Call Forwarding**.
2. Click "On" after the forwarding event (*Always, Busy, Timeout*).
3. Click on "Apply" and "Save".

### Turning call forwarding off

1. Web interface > **Configuration Identity** > **Features** tab > **Call Forwarding**.
2. Click on "Off" after the forwarding event (*Always, Busy, Timeout*).
3. Click on "Apply" and "Save".





## Call completion

On Snom phones call completion means that when a called number is busy or not available, your phone will call you back as soon as the dialed number is not busy anymore or available again. The factory default setting is "off".





**Note:** This function must be supported by your VoIP provider and/or your PBX.

### On the phone

#### Turning on call completion

1. Press  > 2 Call Features > 2 Outgoing Calls > 4  Call Completion.
2. Press  or scroll down to the setting and press  to change it from off to on:  
4  Call Completion.
3. Press  briefly to return to the previous menu, press  for two seconds to return to the idle screen.

#### Turning off call completion

1. Press  > 2 Call Features > 2 Outgoing Calls > 4  Call Completion.
2. Press  or scroll down to the setting and press  to change it from on to off:  
4  Call Completion.
3. Press  briefly to return to the previous menu, press  for two seconds to return to the idle screen.

### On the web interface

Open the phone's web interface > **Advanced Settings** page > **Behavior** tab > **Phone Behavior** section > Call completion: Click the radio button **on**.

## Call waiting

Default setting: When in a call, another call coming in is announced visually in the status line and acoustically by a double beep. See "Call waiting" on page 82 on how to use this feature. Available settings:

- **On:** Visual and acoustic announcement of calls waiting
- **Visual only:** Visual announcement of calls waiting in the status line
- **Ringer:** Acoustic announcement by double beeps
- **Off:** No announcement; callers hear the busy signal

Starting with FW 8.7.5.9, call waiting can be set independently for each identity on the phone's web user interface. If you use the phone to change the setting, it will apply to the current outgoing identity.

### Setting on the phone

1. Press  > 2 Call Features > 3 Incoming Calls > 2 Call Waiting.



2. Select setting with ▲ ▼.
3. Press  to save.



### Setting on the web interface



1. In the menu on the left, click on the identity whose call waiting settings you want to change.
2. Click on the **SIP** tab. The setting **Call Waiting Indication** is the second to last on the page.
3. To turn call waiting off, select "off" from the drop-down menu. Select "visual only" or "ringer" if you want waiting calls announced only by the "phone ringing" symbol or by the double beep, respectively.
4. Click on "Apply" and "Save".

## Hiding my caller ID

With this setting your phone number will not be transmitted to any phones you call. Please note that your call may not be accepted if the other phone is set to reject anonymous calls (see next item).

### Setting on the phone

1. Press  > 2 Call Features > 2 Outgoing Calls > 5  Hide own outgoing ID.
2. Press  or scroll down to the setting and press  to change it from off to on: 5  Hide own outgoing ID.

- Press  briefly to return to the previous menu, press  for two seconds to return to the idle screen.

## Setting on the web interface





- Open **Preferences** page > **Privacy Settings** section > Suppress own number (CLIP/CLIR).
- Select the radio button **Hide**.
- Click on "Apply" and "Save".

## Rejecting anonymous calls

With this setting you will not receive calls from phones whose number is not shown on your display. Anonymous callers will hear the busy signal.

**Please note** that calls from analog phone connections will, most likely, be received as anonymous calls. The default is off.

## Setting on the phone

- Press  > 2 Call Features > 3 Incoming Calls > 1  Reject anonymous.
- Press  or  to change setting from off to on: 1  Reject anonymous.
- Press  briefly to return to the previous menu, press  for two seconds to return to the idle screen.

## Setting on the web interface

- Open the **Preferences** page > **Privacy Settings** section > Reject incoming anonymous calls.
- Select the radio button "Reject".
- Click on "Apply" and "Save".



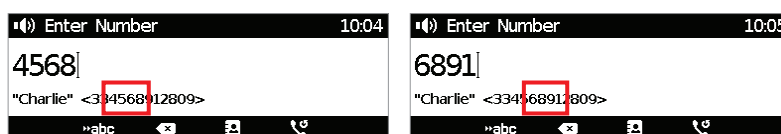

## Number guessing

When you have typed the minimum number of characters you have specified for this function, the phone will look for numbers containing that string of characters in its call lists and directories and, if it finds matches, show the number(s) on the display. If the number proposed on the display is the one you want to dial, press ; if not, continue entering digits.



The default setting is off. You can turn the setting on and off on the phone and on the web interface; changing the minimum number of characters can only be done on the web interface.

## Setting on the phone

1. Press  > 2 Call Features > 2 Outgoing Calls > 3  Number Guessing.
2. Press  or scroll down to the setting and press  to change it from off to on: 3  Number Guessing.
3. Press  briefly to return to the previous menu, press  for two seconds to return to the idle screen.



## Setting on the web interface

1. Open **Advanced Settings** page > **Behavior** tab > **Phone Behavior** section > Number Guessing.
2. Select the radio button "on".
3. Type the minimum number of digits in the text field of "Number Guessing Minimum Length".
4. Click on "Apply" and "Save".

## Speed dial

You can use the numbers 0 to 30 and the special characters # and \* to speed dial frequently dialed and/or long numbers without having to enter the complete phone number. The numbers must be set on the phone's web interface first.

1. In the menu on the left side of the phone's web interface, click on **Speed Dial**.
2. Enter one phone number with any required prefixes (area code, country code, operator/auto attendant, etc.) in the text field for each respective number or special character in the table.

Speed Dial Table:	
0:	<input type="text" value="9115550123"/> 
1:	<input type="text" value="9175550784"/> 



- Type each phone number without spaces or punctuation between the digits.

For example: You want to be able to speed dial phone number 555-0784 in area code 917 by pressing the  key. In conventional notation you might write the number down as (917) 555-0784. In the speed dial table, type 9175550784 into the text field of the number 1.

- If you want to add a name or other data before or after the number, type the number in angled brackets <>. Example: Accounting <9175551784>.

**Note:** If you use this format, you can only dial the speed dial number from the web interface by clicking on the phone symbol on the right side of the line. **You cannot dial the number from the phone by pressing the speed dial number**, but the outgoing call is made by the phone. You can use handset, headset, or speakerphone once the connection has been established.

Speed Dial Table:	
0:	<input type="text" value="XYZ SalesRep. &lt;9175551770&gt;"/> 
1:	<input type="text" value="XYZ Accounting&lt;9175551784&gt;"/> 

3. Click on "Apply" and "Save". You can now speed dial the number by pressing  and  on the phone.



# Software update

## Manual update

1. Open a browser and enter the address <http://wiki.snom.com/Firmware>.
2. Click on the phone to be updated.
3. Click on the firmware version currently running on your phone.
4. Right-click on the link of the firmware version you want to update to.
5. Click on **Copy link location** or **Copy link address** (wording depends on your browser).
6. Open the phone's web interface > **Software Update** page.
7. In the **Manual Software Update** area, paste the link into the text field of "Firmware".
8. Click on **Load**. The phone begins to reboot.
9. If the phone asks "Reboot?", press .
- 10. DO NOT DISCONNECT THE POWER WHILE THE PHONE IS REBOOTING!**

## Auto provisioning



For more information, see our web page [http://wiki.snom.com/Features/Mass\\_Deployment](http://wiki.snom.com/Features/Mass_Deployment).

1. Open the phone's web interface > **Advanced Settings** page > **Update** tab.
2. Please click on the radio button  of each line and read the information on each setting on its Wiki page **before** you configure the setting.
3. Click on **Apply**. If you have changed the setting URL and/or the PnP configuration, a reboot is required before they will take effect.



# Troubleshooting

## Reboot

### In user mode

1. Press .
2. Press 4 Maintenance.
3. Press 2 Reboot.
4. When asked whether to "Reboot?", press .
5. Wait for the idle screen to reappear.

### In admin mode

1. Press .
2. Press 5 Maintenance.
3. Press 2 Reboot.
4. When asked whether to "Reboot?", press .
5. Wait for the idle screen to reappear.



## Hard reboot

Disconnect the power, wait for a few seconds, and reconnect. Wait for the idle screen to reappear.

**Warning:** Never disconnect the power during a firmware update!

## Reset to factory values

The phone can be reset to factory values in admin mode only.

1. Press .
2. Press 5 Maintenance.
3. Press 3 Reset values.
4. Enter the administrator password and press .
5. Wait for the idle screen to reappear.
6. See "Initializing and registering the phone" on page 84 to continue.

**Warning:** All customized settings will be lost!

## TFTP Update

When there is no other way to get the phone to work (administrator password lost, etc.). How it is done: See [http://wiki.snom.com/Firmware/Update/TFTP\\_Update](http://wiki.snom.com/Firmware/Update/TFTP_Update).

**Warning:** All customized settings will be lost!

## Manual initialization

When automatic initialization via DHCP fails, enter the values for netmask, IP gateway, and DNS server manually after each prompt on the display.

## Contacting Snom Support

If you are not a Snom partner, please contact your seller, visit our knowledge base at <http://wiki.snom.com> or our helpdesk at <https://helpdesk.snom.com/support/home> first. You may find the answer to your question or problem in one of the topics there. If you haven't found an answer or a solution to your problem, please post your question or problem on the forum at <https://helpdesk.snom.com/support/discussions>.

**Note:** The forum is accessible to the general public. Do not post any private and/or security-relevant information there. This includes MAC addresses, SIP headers, etc. that may allow others to hack into your system or use your identity for nefarious purposes.

## Submitting a ticket

If you are a Snom partner, log in to the Snom helpdesk and open a ticket: <https://helpdesk.snom.com/support/login>. You'll find the instructions here: <https://helpdesk.snom.com/support/solutions>.

## Submitting system and settings information

### System information

1. Open the phone's web interface > **System Information** page.
2. Copy the text under System Information into your forum posting or into the email, if Support has asked you to contact them by email.

**Make sure to delete the MAC address and the IP address in the public forum posting.**

### Settings information

1. Open the phone's web interface > **Settings** page.
2. Copy the settings list into your forum posting or into the email, if Support has asked you to contact them by email.

**Make sure to delete private and/or security-relevant data like the MAC address, public IP address, etc.**

## Traces

Snom Support may ask you to submit a SIP Trace and/or a PCAP Trace to help them analyze your problem.

### Performing a SIP Trace

1. Open the phone's web interface > **SIP Trace** page.
2. Click on **Clear** to clear the page.
3. Recreate the error to be documented in the trace.
4. Click on **Reload**.
5. Copy the text and submit to Support in whatever form they requested you to use.

**If it is the public forum, make sure to delete private and/or security-relevant data like the MAC address, public IP address, etc.**

### Performing a PCAP Trace

1. Open the phone's web interface > **PCAP Trace** page.
2. Click on **Start** to start recording network traffic.
3. Click on Stop to end recording.
4. Click on the [here](#) link to open the file download window, and save the file.
5. Submit the file to Support in whatever way they requested you to use.

**If it is the public forum, make sure to delete private and/or security-relevant data like the MAC address, public IP address, etc.**



















# Appendix 1 - Display Symbols and Icons

## Symbols found in the function key line

The buttons symbolize the functions that are currently available for activation. Press the function key underneath the symbol to activate the function. The equivalent text symbols used in previous firmware versions can be found in the first column on the right.



























### Programmable function symbols

These are the symbols displayed in the function key line when the phone is idle. They can be selected on the phone's web interface > **Function Keys** page. See "At a glance" on page 87 for the default settings.

	Displaying SIP URLs of all active identities; selecting outgoing identity	Reg
	Server directory	
	Call list menu (missed, received, and dialed calls)	CHist
	Available status messages	Info
	Turning DND on and off	DND
	Contacts list	Contac
	Forwarding all calls (turning on/turning off)	CFwd NoFwd
	Presence signaling on/off	Presen
	Retrieving messages from mailbox	Retr.
	Settings menu	Settin
	Directory	Dir.
	IP address of phone and Snom's web address	Help
	Redial (dialed calls)	Redial
	Received calls	A.Cal.
	Missed calls	Mis.C.
	Favorites	Fav.
	LDAP Directory	LDAP
	Next outgoing ID	Id.v.
	Previous outgoing ID	Id.
	Address book search (OCS accounts only)	ABS

## Context-sensitive symbols











These are the symbols displayed in the function key line when the phone is active, for example when a call is ringing, when you are dialing, etc.

	Confirming a selection or an action	<input type="button" value="Ok"/>
	Terminating/canceling an action and returning to the previous screen	<input type="button" value="Cancel"/>
	Switching input mode to lower case letters	<input type="button" value="abc"/>
	Switching input mode to upper case (capital) letters	<input type="button" value="ABC"/>
	Switching input mode to numerals	<input type="button" value="123"/>
	Deleting the character to the left of the cursor	<input type="button" value="⬅️"/>
	Available directories, contact lists, etc.	<input type="button" value="Pool"/>
	Sorting Directory entries	<input type="button" value="Sort"/>
<sup>1)</sup>	Adding caller's number to Directory	<input type="button" value="Save"/>
	Editing mode for selected Directory entry	<input type="button" value="Edit"/>
	Deleting selected directory entry	<input type="button" value="Del"/>
	Details of missed calls (to, from, date/time, total number) and of received and dialed calls (to, from, date/time, duration)	<input type="button" value="Details"/>
	Returning to idle screen	<input type="button" value="ESC"/>
	Deleting selected call list entry	<input type="button" value="Del"/>
	Deleting entire call list	<input type="button" value="Clear"/>
	Moving to beginning of next time zone	<input type="button" value="Jump"/>
	Expanding the list of time zones to show all	<input type="button" value="More"/>
	Collapsing the list of time zones to show only time zones relevant to the language setting (i.e., countries where the language is spoken)	<input type="button" value="Reduc"/>
	Put call or conference on hold; unhold call	<input type="button" value="Hold"/>
	Selecting call on hold (show caller/callee on-screen)	
	Establishing conference with all calls on hold	<input type="button" value="Cnf.On"/>
	Call transfer	<input type="button" value="Xfer"/>
	Turning on the casing speaker	<input type="button" value="+Spkr"/>
	Turning off the casing speaker	<input type="button" value="-Spkr"/>
	When the phone is in a call and another incoming call waiting is indicated by a double beep and this symbol in the function key line, press the key underneath the symbol to put the call waiting on-screen. When the call waiting is on-screen, you can terminate it by pressing  (the caller will hear the busy signal); or you can accept it (and simultaneously put the first call on hold) by pressing  .	<input type="button" value="📞"/>













<sup>1)</sup> Via directory casing key only (see "At a glance" on page 18)

# Display indications

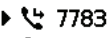

## On activity

	Outgoing call ringing	
	Incoming call ringing	 or 
	Connected (single connection or conference)	 or 
	Holding call	 or 
	Call being held by other party	

## On idle screen

	<p><b>Outgoing identity</b></p> <ul style="list-style-type: none"> <li>The current outgoing identity is indicated by the black phone symbol. When you call someone, this is your identity for the call.</li> <li>If there is more than one active identity, an arrow precedes the current outgoing identity:  7903.</li> <li>Select a different identity for the next call by pressing ▲ or ▼ on the navigation key.</li> </ul>	
	<p><b>Active identity</b></p> <ul style="list-style-type: none"> <li>Other configured and active identities are indicated by the white phone symbol:  7904.</li> <li>Active identities can be called.</li> <li>Active identities can be selected as the outgoing identity for making calls by pressing ▲ or ▼ on the navigation key.</li> </ul>	
	Identity not properly registered	
	<p>By changing the status of an identity to "inactive" on the phone's web interface, it can be deregistered without removing its registration settings. Inactive identities are not shown on the idle screen. They cannot be called or selected as the outgoing identity. To deregister the identity, open the phone's web interface &gt; <b>Configuration Identity</b> (1-12).</p> <ol style="list-style-type: none"> <li>Change the "Identity active" setting to "off".</li> <li>Click on "Re-Register".</li> <li>Click on "Save".</li> </ol>	
	<p>Forwarding all incoming calls:  Forward All: 159 14:17</p> <p> 7783</p>	

## Appendix 2 - Status Messages

Whenever there is a current message concerning the status of the phone, the function key  will be available. Press the function key or, if it not available,  > 6 Information > 1 Status Info) to open the "Status info" screen. Additionally, some status messages will also be displayed in the status bar; if there is more than one current message, the one with the highest priority will be shown. The messages in descending order of priority:

Status message	Definition
SW <sup>1</sup>	A firmware update is available
Reboot required <sup>1</sup>	Reboot required, for example to have settings changes take effect
SIP disabled <sup>1,2</sup>	The phone cannot make calls due to license problems
Error <sup>1</sup>	An error occurred
Low memory <sup>1</sup>	Disk space full
Remote directory is too big <sup>1</sup>	The remote directory is too big to be imported
Not Registered: <account> <sup>1,2</sup>	The specified identity/account is not registered
Waiting for <name/number> to be available <sup>2</sup>	Waiting for call completion to busy or currently unavailable number
<account> is now available <sup>2</sup>	The dialed number is not busy anymore or is now available
Forward when Busy: <name/number>	Call forwarding is on. When your phone is busy, incoming calls will be forwarded to the phone number indicated
Forward after Timeout: <name/number>	Call forwarding is on. When an incoming call is not picked up within the set number of seconds, the call will be forwarded to the phone number indicated
Forward all: <name/number> <sup>2</sup>	Forwarding of all incoming calls is on. All incoming calls will be forwarded to the phone number indicated.
Contacting NTP server	Network Time Protocol (NTP) is a protocol for synchronizing clocks over data network. If the connection is interrupted, the phone will not be able to display the correct time.
NTP server unreachable <sup>1</sup>	
HTTP Password not set <sup>1</sup>	No HTTP password has been set
Admin Password not set <sup>1</sup>	No Admin password has been set
Keyboard locked <sup>2</sup>	Only numbers designated as emergency numbers can be dialled
DND active <sup>2</sup>	Do not Disturb mode is activated
You have messages	There are spoken messages on the mailbox
You have new messages	New (messages on the mailbox)
Old messages	Old (messages on the mailbox)
Missed: <number>	The number of calls you missed since the last time you checked the list of missed calls or turned off the missed call indication

<sup>1</sup> The function key symbol  will blink

<sup>2</sup> The message cannot be deleted from the "Status Info" screen



# Appendix 3 - Wall Mounting

Not included in the delivery are the two screws (diameter of head between 6 and 9 mm, diameter of body max. 4.5 mm) and two screw anchors/molly bolts/wall plugs appropriate for your type of wall.

1. Anchor the screws in the wall, using the measurements given in Fig. 1 and Fig. 2.
2. Unscrew the slide guides for the footstand from the back of the phone (Fig. 3).
3. Plug the long end of the handset cord into the connector labelled " " on the back of the phone and place the cord in the cable guide (Fig. 4).
4. Hang the phone on the screws by placing the holes on the back of the phone over them (Fig. 5).

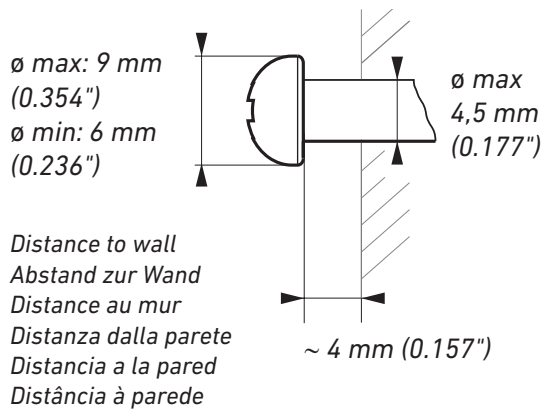

Fig. 1

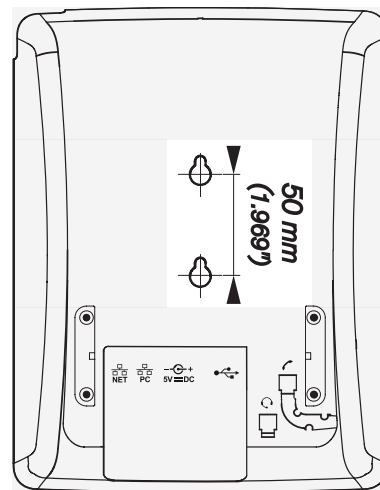

Fig. 2

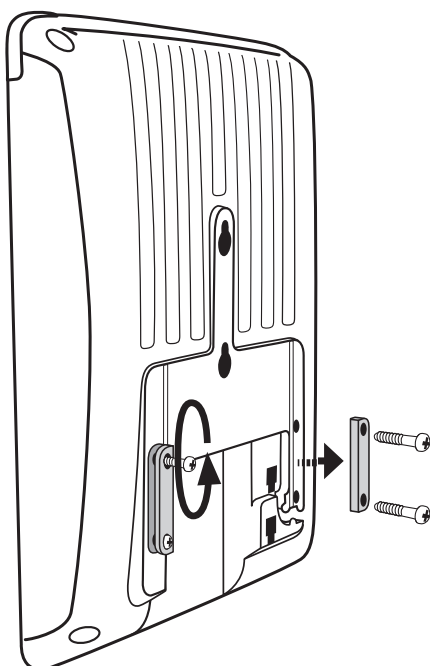

Fig. 3

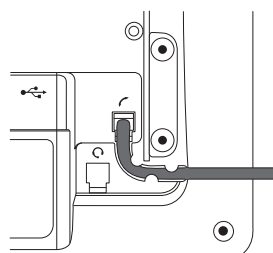

Fig. 4

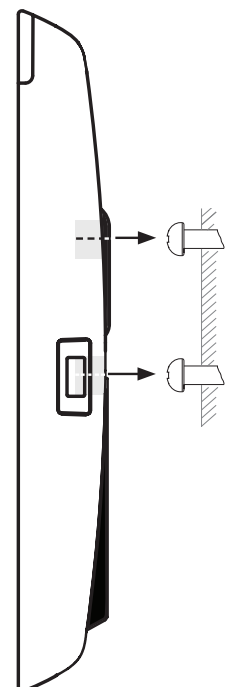

Fig. 5

## Appendix 4 - Programmable Functions

Following is a brief description of the function key settings available on the **Function keys** page of the phone's web interface.



### Freely programmable functions

Action URL	Action URLs are basically HTTP GET Requests that allow the phone to interact with web server applications. They can be used to send various data from the phone to a web server, like the customized settings stored on the phone; passwords are replaced by empty strings. Action URLs can be triggered by predefined events ("Action URL Settings" page of the phone's web interface) or manually by a pressing a function key that has been programmed to trigger an action.
Auto Answer	With this setting, your phone will automatically accept incoming calls when it is idle. If you leave the text field empty, incoming calls for all configured identities will be accepted; if you enter the number of an identity in the text field, only calls to that identity will be accepted automatically (i.e., 1 for Identity 1, 2 for Identity 2 etc.).
BLF (Busy Lamp Field)	This function key allows showing the status (idle, ringing, held call, busy) of another extension on the key's LED. By pressing the key, it may also be possible to pick up calls ringing on the extension, to dial the extension when the phone is idle, and to transfer an incoming call ringing on your own extension. These functionalities depend on your PBX; for more information, please check snom's interoperability page and the PBX manual. With Asterisk, generally use this feature rather than extension.
Button	This is a function key that is connected to your PBX to perform a task specified in the buttons document. For more information, see the detailed feature description at <a href="http://wiki.snom.com/Features/LED_Remote_Control">http://wiki.snom.com/Features/LED_Remote_Control</a> .
Call Agent	This function key can be used by call agents to perform one of three different functions, depending on the value entered in the "Number" text field: <ul style="list-style-type: none"> <li>Logging onto and off the system. Text field entry: F_CALL_AGENT_LOGGEDIN.</li> <li>Signaling readiness to accept calls. For this function to work, the agent must be logged in. Text field entry: F_CALL_AGENT_READY.</li> <li>Announcing that they are working after a call. For this function to work, the agent must be logged in. Text field entry: F_CALL_AGENT_WORKINGAFTERCALL.</li> </ul>

Conference Server	<p>This function key can be used for PBX-based conferences and for local conferences on the phone itself.</p> <ul style="list-style-type: none"> <li>• PBX-based conferences. When a conference room or conference account has been created on the server for an individual identity, you can dedicate a function key to calling and monitoring the conference room. Select the identity and the "Conference server" function from the respective drop-down menus and enter the SIP URI of the conference room in the "Number" text field. For information on how to use this key with your particular PBX, please check the PBX manual.</li> <li>• Phone-based conferences. If there is no SIP URI in the text field, pressing the function key will initiate a phone-based conference with all held calls and any active call.</li> </ul>
DTMF	<p>This function allows the specification of arbitrary key sequences (allowed digits: "0-9", "**", "#", "A-D" and flash: "!") which will be sent via DTMF when this key is pressed during an active call.</p>
Extension	<p>This function key allows showing the status (idle, ringing, held call, busy) of another extension on the key's LED. By pressing the key, it may also be possible to pick up calls ringing on the extension, to dial the extension when the phone is idle, and to transfer an incoming call ringing on your own extension. These functionalities depend on your PBX; for more information, please check snom's interoperability page and the PBX manual. With Asterisk, generally use BLF rather than this function.</p>
Forward to	<p>All incoming calls will be forwarded to the number (extension or external phone number) specified under "Number". The key is used to turn forwarding of all calls on and off; the red LED lights up when the function is turned on.</p>
Intercom	<p>Pressing a function key mapped with "Intercom" will establish a two-way connection to the extension specified in the "Number" text field; that extension must have enabled intercom reception on its web interface (<b>Advanced Settings &gt; Behavior tab &gt; Phone Behavior &gt; Intercom Policy</b> "only in idle" or "always").</p> <p><u>"Intercom Policy" settings on the phone being called via intercom:</u></p> <p><b>Always:</b> The intercom call will connect to the called phone automatically; if the called phone is in a call, that call will be placed on hold.</p> <p><b>Only in idle:</b> The intercom call will connect to the called phone automatically if the called phone is idle. If it is in a call, the incoming intercom call will be announced as call waiting.</p> <p><b>Off:</b> Pressing the intercom key will call the extension specified in the "Number" text field where it will be treated like any other incoming call, i.e., ring, be forwarded, etc.</p>



IVR	<p>This function key can be used for regular calls to an extension that is reached via an IVR or auto attendant and a number of voice prompts where the caller has to make a selection by pressing a key after or during the prompt. If you know which keys need to be pressed in which order in order to reach the desired extension, the entire process can be automated and considerably speeded up.</p> <p>The syntax for the "Number" text field entry is <code>&lt;phone_number&gt;;dtmf=&lt;n&gt;,&lt;n&gt;</code>, etc. The angle brackets <code>&lt;&gt;</code> including their content are placeholders for the variables that you must replace by the actual characters. The comma represents a pause of one second, and <code>n</code> represents any number key on the alphanumeric keypad.</p> <p><b>Example:</b> The number to dial is (917) 555-3814. When the connection has been established, the caller will hear three prompts. After the first prompt, he must press key 1; after the second prompt, he must press 3; and after the third prompt he must press 1 to reach the desired extension. The entry in the "Number" text field must look like this: <code>9175553814;dtmf=1,3,1</code>.</p> <p><b>Usage:</b> When the phone is in idle mode, press the key to dial the number. As soon as the connection has been established, the phone will automatically send the DTMF tones associated with the alphanumeric keys 1, 3, and 1 with a one-second pause between them.</p> <p>(If the function type "IVR" doesn't work on individual phones, try "Speed dial" with the above description.)</p>
Key Event	<p>When this key type is selected, a drop-down menu opens under "Number". For the available selections, see the following section "Key Events".</p>
Line	<p>Default setting for all freely programmable function keys. Incoming calls will go to the first free "line" key, and outgoing calls will use the first free line key.</p> <p>Line keys can be used to make outgoing calls with the identity selected from a particular key's "Context" menu and to have incoming calls for that identity going to that particular function key. If the key is busy, the incoming call will go to the first free line key.</p>
Multicast Page	<p>This function key enables the phone to send multicast streams to IP multicast group addresses. The multicast IP address and port are entered in the "Number" text field in the format <code>&lt;multicast IP address&gt;:&lt;port&gt;</code> (e.g., <code>239.255.255.245:5555</code>). The angle brackets <code>&lt;&gt;</code> including their content are placeholders for the variables that you must replace by the actual characters.</p> <p><b>Please note:</b> This key is for <b>sending</b> multicast streams. To <b>allow reception</b> of multicast streams, multicast support must be enabled on the phone's web interface, Advanced settings &gt; SIP/RTP tab &gt; Multicast by setting Multicast Support to "on". You must also enter the IP addresses of the multicasts you wish to receive in ascending order of priority, 10 being the highest. In case of simultaneous multicasts, the one with the highest priority at any given time will override the others.</p>
Park Orbit	<p>If a park orbit has been set up on the server, a function key mapped with the Park Orbit functionality can EITHER serve to park calls on the park orbit OR to park as well as retrieve calls, depending on the type of server used. Select the server type on the Configuration Identity page of the context identity, SIP tab, from the "Server Type Support" drop-down menu. Enter the "phone number" of the Park Orbit and/or the park position in the text field of "Number", for example <code>orbit1@my.proxy.com</code> or <code>700@my.proxy.com</code> etc.</p>

Presence	If supported by your PBX, the LED of this function key will reflect the presence status (ringing, busy, available, etc.) of the extension specified in the "Number" text field. The function key can also be used to dial the extension, usually when the destination signals availability.
Push2Talk	<p>Pressing the function key mapped with "Push2Talk" will establish a two-way connection to the extension specified in the "Number" text field for as long as the key is pressed; that extension must have enabled intercom reception on its web interface (<b>Advanced Settings &gt; Behavior tab &gt; Phone Behavior &gt; Intercom Policy</b> "only in idle" or "always").</p> <ul style="list-style-type: none"> <li>• On 870 phones, this key type will establish an Intercom connection.</li> <li>• On 820/821 phones, this key type is only available on keys P2 and P3.</li> <li>• On 760 phones, this key type is not available on key P4.</li> </ul>
Shared Line	Bridged lines (Bridged Line Appearance (BLA)) are shared by two or more users; when one of them is using the line, the others are blocked from using it. This key type makes it possible to monitor whether a shared line is busy (the LED is lit) or not (the LED is off). The URI of the shared line is set under "Number".
Speed Dial	<p>Besides using the "Speed Dial" page on the web interface to program speed dial numbers, you can also put the functionality on the freely programmable function keys with LEDs to be able to speed dial frequently used and/or long numbers without having to enter the complete phone number.</p> <p>Enter one phone number with any required prefixes (area code, country code, operator/ auto attendant, etc.) in the "Number" text field for any given freely programmable function key with LEDs. Example: 0019175557813.</p> <p>Or enter a partial phone number (country, area code etc.) and complete the number on the dialog screen. In this case, enter the partial number, followed by a semicolon and "number=incomplete" in the text field. Example: 001917555; number=incomplete.</p>
Starcode	<p>Making SIP calls without audiovisual indication on the phone user interface (PUI).</p> <p>Examples for using this feature:</p> <ul style="list-style-type: none"> <li>• Controlling settings on the PBX with dedicated keys that turn PBX functions on and off. The available functions must have been set on the PBX and they must be accessible from the phone, typically by dialing a star code. Phone function keys can be dedicated to activating and deactivating call forwarding and DND mode, transferring, picking up, and parking/unparking calls, etc. Depending on the settings on your PBX, you may either have to dedicate one key each for activating and deactivating a given function or to dedicate one key for both activating and deactivating the function.</li> <li>• Silent alarms or emergency calls.</li> </ul> <p>If the standard behavior of this function key type does not meet your requirements, it is possible to customize it. Copy the standard XML configuration of the key from the Settings page of the phone's web user interface (WUI) and edit it to suit your needs. Then paste the edited XML into the "Number" text field and change the key's type to "Xml definition".</p>

Transfer to	<p>Transferring active calls and ringing incoming calls to the number set in the "Number" text field. Pressing the key once will transfer the active or ringing call.</p> <p>If the text field is empty, pressing the key will put the "Enter number" screen on the display. Enter the number and press  /  to complete the transfer.</p> <p>For further information, see the article "Transferring calls" in the chapter "Using the phone".</p>
Voice Recorder	<p>The phone does not record the voice streams at all; they must be recorded on the PBX where a recording account must be set up. Pressing the key when the phone is idle will establish a connection between the phone and the recording account, making it possible to record spoken memos, meetings, or conferences. Pressing the key during a call will establish a three-party conference with the two phones and the recording account as participants. Please be advised that you must respect the legal restrictions of your country for recording calls with or without the participants' knowledge and permission.</p>
Xml Definition	<p>Copy the XML sub tag of the action(s) you want the key to perform into the text field. The currently available settings can be found here: <a href="http://wiki.snom.com/Features/Mass_Deployment/Setting_Files/XML/XmlSubTags">http://wiki.snom.com/Features/Mass_Deployment/Setting_Files/XML/XmlSubTags</a>.</p>

## Key Events

ABS	Address book search (OCS accounts)
Accepted Calls	(Accepted List) List of calls accepted on the phone
Call Lists	Call history list (missed, received, dialed calls)
Change active ID	List of registered SIP identities
Conference	Starting a conference
Contacts	Contact List, where the Presence State of selected users can be seen (online, busy, offline)
Directory	Internal phone directory
DND	Turning "Do not disturb" function (DND) on an off. When mapped to a function key with an LED, the LED will light up when DND is turned on.
Favorites	Favorites list
Forward all	All incoming calls will be forwarded to another extension or an external phone number. After turning call forwarding on with this key, the display will prompt you to enter - or confirm/change a previously entered - forwarding number.
Help	<p>FW versions lower than 8: Phone's IP address, MAC address, and firmware version.</p> <p>FW 8 and higher: Phone's IP address and the URI to Snom Wiki. IP address, MAC address, and firmware version can be found in Settings &gt; 6 Information &gt; 2 System Information.</p>
Hold	Placing the active call on hold

LDAP Directory	Allows the user to look up a remote directory while dialing. Once set, this pressed key will open up the Directory Search window. If LDAP is setup, corresponding matching entries as returned by the sever will be shown. If LDAP is not used and and presence_lookup_number setting is turned on, the contact matches will be shown. The default edit mode is alphanumeric in this state.
Logoff Identities	Caution: This option will delete all account settings!!  Usage: Mainly useful for call centers with frequently changing users.
Menu	Calling up the settings menu of the phone
Missed Calls	Missed call history list
Monitor Calls  (not available on Snom 300)	When the phone has been programmed to monitor extensions and do/allow call pickup, a key can be mapped to show the list of monitored extensions and do call pickup from the monitor.  FW v8.7.2 and higher: The list will show only active extensions (i.e., busy or ringing). When there is no activity on any monitored extensions, the list is empty.
Mute	Mutes/unmutes the microphone (handset, speakerphone, headset) during active call
Next Outgoing ID	Selecting the next identity as the outgoing identity
Presence State	Providing access to a list where the Presence state of each registered SIP Identity can be defined (online, offline, busy, invisible).
Prev. Outgoing ID	Selecting the previous identity as the outgoing identity
Reboot	Rebooting the phone
Record	The phone does not record the voice streams at all; they must be recorded on the PBX or other external device. Pressed during a call, the key informs the PBX to start and stop the recording of the audio stream on the PBX. While the call is being recorded, the recording symbol ● will either blink on the display or be displayed, in red ●, in the status line, depending on the phone type; if the function key has an LED, the LED will be lit throughout the recording. Please be advised that you must respect the legal restrictions of your country for recording calls with or without the participants' knowledge and permission.
Redial	Dialed call history list (last call at the top)
Retrieve	Retrieves new mailbox messages. This key becomes active when the phone has received a message waiting indication (MWI) with a valid mailbox URI.
Status Messages	Currently available status messages (see Appendix 2)
Transfer	Transferring the active call or an incoming call that you do not want to pick up. See the article <b>Transferring calls</b> in the chapter <b>Using the phone</b> .  Pressing the key will put the "Enter number" screen on the display. Enter the number and press  /  to complete the transfer.

# Appendix 5 - GNU General Public License

## COPYRIGHT NOTICE AND WARRANTY DISCLAIMER

I.

Das Produkt enthält Software, die unter der GNU General Public License, Version 2, frei genutzt werden darf.

This Product contains Software applicable to GNU General Public License, Version 2 which can be used freely.

II.

Im Verhältnis zu den Lizenzgebern der Software gilt der folgende Haftungsausschluss:

Towards the licensor of this Software the following liability is disclaimed:

This program is distributed in the hope that it will be useful, but WITHOUT ANY WARRANTY; without even the implied warranty of MERCHANTABILITY or FITNESS FOR A PARTICULAR PURPOSE. See the GNU General Public License for more details.

III.

Der Lizenztext der GPL lautet wie folgt:  
The GNU General Public License is as follows:

### GNU GENERAL PUBLIC LICENSE

Version 2, June 1991

Copyright (C) 1989, 1991  
Free Software Foundation, Inc.  
59 Temple Place, Suite 330  
Boston, MA 02111-1307, USA

Everyone is permitted to copy and distribute verbatim copies of this license document, but changing it is not allowed.

#### Preamble

The licenses for most software are designed to take away your freedom to share and change it. By contrast, the GNU General Public License is intended to guarantee your freedom to share and change free software - to make sure the software is free for all its users. This General Public License applies to most of the Free Software Foundation's software and to any other program whose authors commit to using it. (Some other Free Software Foundation software is covered by the GNU Library General Public License instead.) You can apply it to your programs, too.

When we speak of free software, we are referring to freedom, not price. Our General Public Licenses are designed to make sure that you have the freedom to distribute copies of free software (and charge for this service if you wish), that you receive source code or can get it if you want it, that you can change the software or use pieces of it in new free programs; and that you know you can do these things.

To protect your rights, we need to make restrictions that forbid anyone to deny you these rights or to ask you to surrender the rights. These restrictions translate to certain responsibilities for you if you distribute copies of the software, or if you modify it. For example, if you distribute copies of such a program, whether gratis or for a fee, you must give the recipients all the rights that you have. You must make sure that they, too, receive or can get the source code. And you must show them these terms so they know their rights.

We protect your rights with two steps: (1) copyright the software, and (2) offer you this license which gives you legal permission to copy, distribute and/or modify the software.

Also, for each author's protection and ours, we want to make certain that everyone understands that there is no warranty for this free software. If the software is modified by someone else and passed on, we want its recipients to know that what they have is not the original, so that any problems introduced by others will not reflect on the original authors' reputations.

Finally, any free program is threatened constantly by software patents. We wish to avoid the danger that redistributors of a free program will individually obtain patent licenses, in effect making the program proprietary. To prevent this, we have made it clear that any patent must be licensed for everyone's free use or not licensed at all.

The precise terms and conditions for copying, distribution and modification follow.

### GNU GENERAL PUBLIC LICENSE

#### TERMS AND CONDITIONS FOR COPYING, DISTRIBUTION AND MODIFICATION

0. This License applies to any program or other work which contains a notice placed by the copyright holder saying it may be distributed under the terms of this General Public License. The "Program", below, refers to any such program or work, and a "work based on the Program" means either the Program or any derivative work under copyright law: that is to say, a work containing the Program or a portion of it, either verbatim or with modifications and/or translated into another language. (Hereinafter, translation is included without limitation in the term "modification".) Each licensee is addressed as "you".

Activities other than copying, distribution and modification are not covered by this License; they are outside its scope. The act of running the Program is not restricted, and the output from the Program is covered only if its contents constitute a work based on the Program (independent of having been made by running the Program). Whether that is true depends on what the Program does.

1. You may copy and distribute verbatim copies of the Program's source code as you receive it, in any medium, provided that you conspicuously and appropriately publish on each copy an appropriate copyright notice and disclaimer of warranty; keep intact all the notices that refer to this License and to the absence of any warranty; and give any other recipients of the Program a copy of this License along with the Program.

You may charge a fee for the physical act of transferring a copy, and you may at your option offer warranty protection in exchange for a fee.

2. You may modify your copy or copies of the Program or any portion of it, thus forming a work based on the Program, and copy and distribute such modifications or work under the terms of Section 1 above, provided that you also meet all of these conditions:

a) You must cause the modified files to carry prominent notices stating that you changed the files and the date of any change.

b) You must cause any work that you distribute or publish, that in whole or in part contains or is derived from the Program or any part thereof, to be licensed as a whole at no charge to all third parties under the terms of this License.

c) If the modified program normally reads commands interactively when run, you must cause it, when started running for such interactive use in the most ordinary way, to print or display an announcement including an appropriate copyright notice and a notice that there is no warranty (or else, saying that you provide a warranty) and that users may redistribute the program under these conditions, and telling the user how to view a copy of this License. (Exception: if



the Program itself is interactive but does not normally print such an announcement, your work based on the Program is not required to print an announcement.)

These requirements apply to the modified work as a whole. If identifiable sections of that work are not derived from the Program, and can be reasonably considered independent and separate works in themselves, then this License, and its terms, do not apply to those sections when you distribute them as separate works. But when you distribute the same sections as part of a whole which is a work based on the Program, the distribution of the whole must be on the terms of this License, whose permissions for other licensees extend to the entire whole, and thus to each and every part regardless of who wrote it.

Thus, it is not the intent of this section to claim rights or contest your rights to work written entirely by you; rather, the intent is to exercise the right to control the distribution of derivative or collective works based on the Program. In addition, mere aggregation of another work not based on the Program with the Program (or with a work based on the Program) on a volume of a storage or distribution medium does not bring the other work under the scope of this License.

3. You may copy and distribute the Program (or a work based on it, under Section 2) in object code or executable form under the terms of Sections 1 and 2 above provided that you also do one of the following:

- a) Accompany it with the complete corresponding machine-readable source code, which must be distributed under the terms of Sections 1 and 2 above on a medium customarily used for software interchange; or,
- b) Accompany it with a written offer, valid for at least three years, to give any third party, for a charge no more than your cost of physically performing source distribution, a complete machine-readable copy of the corresponding source code, to be distributed under the terms of Sections 1 and 2 above on a medium customarily used for software interchange; or,
- c) Accompany it with the information you received as to the offer to distribute corresponding source code. (This alternative is allowed only for noncommercial distribution and only if you received the program in object code or executable form with such an offer, in accord with Subsection b above.)

The source code for a work means the preferred form of the work for making modifications to it. For an executable work, complete source code means all the source code for all modules it contains, plus any associated interface definition files, plus the scripts used to control compilation and installation of the executable. However, as a special exception, the source code distributed need not include anything that is normally distributed (in either source or binary form) with the major components (compiler, kernel, and so on) of the operating system on which the executable runs, unless that component itself accompanies the executable.

If distribution of executable or object code is made by offering access to copy from a designated place, then offering equivalent access to copy the source code from the same place counts as distribution of the source code, even though third parties are not compelled to copy the source along with the object code.

4. You may not copy, modify, sublicense, or distribute the Program except as expressly provided under this License. Any attempt otherwise to copy, modify, sublicense or distribute the Program is void, and will automatically terminate your rights under this License. However, parties who have received copies, or rights, from you under this License will not have their licenses terminated so long as such parties remain in full compliance.

5. You are not required to accept this License, since you have not signed it. However, nothing else grants you permission to

modify or distribute the Program or its derivative works. These actions are prohibited by law if you do not accept this License. Therefore, by modifying or distributing the Program (or any work based on the Program), you indicate your acceptance of this License to do so, and all its terms and conditions for copying, distributing or modifying the Program or works based on it.

6. Each time you redistribute the Program (or any work based on the Program), the recipient automatically receives a license from the original licensor to copy, distribute or modify the Program subject to these terms and conditions. You may not impose any further restrictions on the recipients' exercise of the rights granted herein. You are not responsible for enforcing compliance by third parties to this License.

7. If, as a consequence of a court judgment or allegation of patent infringement or for any other reason (not limited to patent issues), conditions are imposed on you (whether by court order, agreement or otherwise) that contradict the conditions of this License, they do not excuse you from the conditions of this License. If you cannot distribute so as to satisfy simultaneously your obligations under this License and any other pertinent obligations, then as a consequence you may not distribute the Program at all. For example, if a patent license would not permit royalty-free redistribution of the Program by all those who receive copies directly or indirectly through you, then the only way you could satisfy both it and this License would be to refrain entirely from distribution of the Program.

If any portion of this section is held invalid or unenforceable under any particular circumstance, the balance of the section is intended to apply and the section as a whole is intended to apply in other circumstances.

It is not the purpose of this section to induce you to infringe any patents or other property right claims or to contest validity of any such claims; this section has the sole purpose of protecting the integrity of the free software distribution system, which is implemented by public license practices. Many people have made generous contributions to the wide range of software distributed through that system in reliance on consistent application of that system; it is up to the author/donor to decide if he or she is willing to distribute software through any other system and a licensee cannot impose that choice. This section is intended to make thoroughly clear what is believed to be a consequence of the rest of this License.

8. If the distribution and/or use of the Program is restricted in certain countries either by patents or by copyrighted interfaces, the original copyright holder who places the Program under this License may add an explicit geographical distribution limitation excluding those countries, so that distribution is permitted only in or among countries not thus excluded. In such case, this License incorporates the limitation as if written in the body of this License.

9. The Free Software Foundation may publish revised and/or new versions of the General Public License from time to time. Such new versions will be similar in spirit to the present version, but may differ in detail to address new problems or concerns. Each version is given a distinguishing version number. If the Program specifies a version number of this License which applies to it and „any later version“, you have the option of following the terms and conditions either of that version or of any later version published by the Free Software Foundation. If the Program does not specify a version number of this License, you may choose any version ever published by the Free Software Foundation.

10. If you wish to incorporate parts of the Program into other free programs whose distribution conditions are different, write to the author to ask for permission. For software which is copyrighted by the Free Software Foundation, write to the Free Software Foundation; we sometimes make exceptions for this. Our decision will be guided by the two goals of preserving the free status of all derivatives of our free software and of promoting the sharing and reuse of software generally.

**NO WARRANTY**

11. BECAUSE THE PROGRAM IS LICENSED FREE OF CHARGE, THERE IS NO WARRANTY FOR THE PROGRAM, TO THE EXTENT PERMITTED BY APPLICABLE LAW. EXCEPT WHEN OTHERWISE STATED IN WRITING THE COPYRIGHT HOLDERS AND/OR OTHER PARTIES PROVIDE THE PROGRAM „AS IS“ WITHOUT WARRANTY OF ANY KIND, EITHER EXPRESSED OR IMPLIED, INCLUDING, BUT NOT LIMITED TO, THE IMPLIED WARRANTIES OF MERCHANTABILITY AND FITNESS FOR A PARTICULAR PURPOSE. THE ENTIRE RISK AS TO THE QUALITY AND PERFORMANCE OF THE PROGRAM IS WITH YOU. SHOULD THE PROGRAM PROVE DEFECTIVE, YOU ASSUME THE COST OF ALL NECESSARY SERVICING, REPAIR OR CORRECTION.

12. IN NO EVENT UNLESS REQUIRED BY APPLICABLE LAW OR AGREED TO IN WRITING WILL ANY COPYRIGHT HOLDER, OR ANY OTHER PARTY WHO MAY MODIFY AND/OR REDISTRIBUTE THE PROGRAM AS PERMITTED ABOVE, BE LIABLE TO YOU FOR DAMAGES, INCLUDING ANY GENERAL, SPECIAL, INCIDENTAL OR CONSEQUENTIAL DAMAGES ARISING OUT OF THE USE OR INABILITY TO USE THE PROGRAM (INCLUDING BUT NOT LIMITED TO LOSS OF DATA OR DATA BEING RENDERED INACCURATE OR LOSSES SUSTAINED BY YOU OR THIRD PARTIES OR A FAILURE OF THE PROGRAM TO OPERATE WITH ANY OTHER PROGRAMS), EVEN IF SUCH HOLDER OR OTHER PARTY HAS BEEN ADVISED OF THE POSSIBILITY OF SUCH DAMAGES.

END OF TERMS AND CONDITIONS

### **How to Apply These Terms to Your New Programs**

If you develop a new program, and you want it to be of the greatest possible use to the public, the best way to achieve this is to make it free software which everyone can redistribute and change under these terms.

To do so, attach the following notices to the program. It is safest to attach them to the start of each source file to most effectively convey the exclusion of warranty; and each file should have at least the "copyright" line and a pointer to where the full notice is found.

<one line to give the program's name and a brief idea of what it does>Copyright (C) <year> <name of author>

This program is free software; you can redistribute it and/or modify it under the terms of the GNU General Public License as published by the Free Software Foundation; either version 2 of the License, or (at your option) any later version.

This program is distributed in the hope that it will be useful, but WITHOUT ANY WARRANTY; without even the implied warranty of MERCHANTABILITY or FITNESS FOR A PARTICULAR PURPOSE. See the GNU General Public License for more details.

You should have received a copy of the GNU General Public License along with this program; if not, write to the Free Software Foundation, Inc., 59 Temple Place, Suite 330, Boston, MA 02111-1307 USA

IV.

Den vollständigen korrespondierenden Sourcecode der Software schickt Ihnen die Snom Technology AG auf Nachfrage gerne auf einem üblichen Datenträger gegen Erstattung der Herstellungskosten in Höhe von EUR 5,- zu.

Der vollständige korrespondierende Sourcecode kann auch über unsere Website unter [http://www.snom.com/gpl\\_html?&L=0](http://www.snom.com/gpl_html?&L=0) herunter geladen werden.

If requested by you, the complete corresponding source code of the Software can be sent by Snom Technology AG on a standard data storage medium against the reimbursement of the manufacturing costs of EUR 5.- per unit.

The complete corresponding source code of the Software can also be downloaded from our web site [http://www.snom.com/gpl\\_html?&L=0](http://www.snom.com/gpl_html?&L=0).

V..

Weitere Informationen finden Sie auch unter <http://www.snom.com>.

For further information see <http://www.snom.com>.