

Quick Installation Guide

Snom EHS Advanced

Adapter for Wireless Headsets

**Delivery content · Lieferumfang · Contenu de la boîte ·
Contenuto della confezione · En la caja**

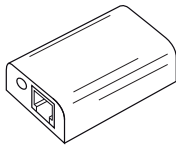
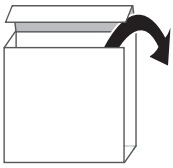

A 2 x RJ12

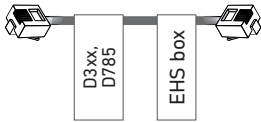

B RJ45 | RJ12



C Snom connector | RJ12

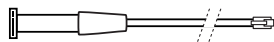

D 2 x RJ45



E 2 x 3.5 mm stereo

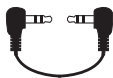

Snom Technology GmbH
Aroser Allee 66
13407 Berlin
Germany

office.de@snom.com

Snom Technology GmbH
office.fr@snom.com

Snom Technology GmbH
office.it@snom.com

Snom Technology Ltd.
office.tw@snom.com

Snom Technology GmbH
office.uk@snom.com

VTech - Snom Americas
supportusa@snom.com

ENGLISH

Safety

Follow the safety instructions of the phone and the headset that the device will be connected to. For further information, please consult the manuals of your phone and your headset and the Snom Service Hub.

© 2024 Snom Technology GmbH. All rights reserved. Product specifications are subject to change without notice.

DEUTSCH

Sicherheit

Befolgen Sie die Sicherheitshinweise des Telefons und des Headsets, an die Sie das Gerät anschließen. Weitere Informationen finden Sie in den Bedienungsanleitungen Ihres Telefons und Ihres Headsets und in unserem Service Hub.

© 2024 Snom Technology GmbH. Alle Rechte vorbehalten. Die Produktspezifikationen können ohne Vorankündigung verändert werden.

FRANÇAIS

Sécurité

Suivez les instructions de sécurité du téléphone et du casque micro auxquels vous voulez connecter l'appareil. Consultez les manuels de votre téléphone et de votre casque micro et notre Service Hub pour des informations complémentaires.

© 2024 Snom Technology GmbH. Tous droits réservés. Snom se réserve le droit de modifier les fonctionnalités des produits sans avertissement préalable.

ITALIANO

Sicurezza

Seguite le istruzioni di sicurezza del telefono e del auricolare. Per ulteriori informazioni consultare i manuali del tuo telefono e del tuo auricolare e anche nostra Service Hub

© 2024 Snom Technology GmbH. Tutti i diritti riservati. Le specifiche tecniche del prodotto possono essere variate senza previa notifica.

ESPAÑOL

Seguridad

Siga las instrucciones de seguridad del teléfono. Para más información, consulte los manuales de su teléfono y de su auricular y también nuestra Service Hub.

© 2024 Snom Technology GmbH. Todos los derechos reservados. Las especificaciones de producto están sujetas a cambios sin previo aviso.

<https://service.snom.com> -> Accessories

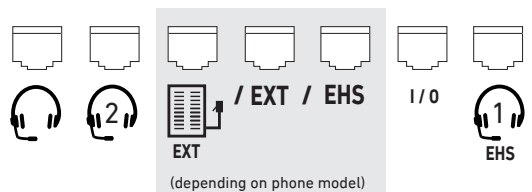

Connecting - Anschließen - Connector - Conectar - Collegare

Connecting - Anschließen - Connector - Conectar - Collegare

Snom phone + GN Netcom/Jabra Headset⁽¹⁾

Snom phone + Plantronics Headset⁽¹⁾

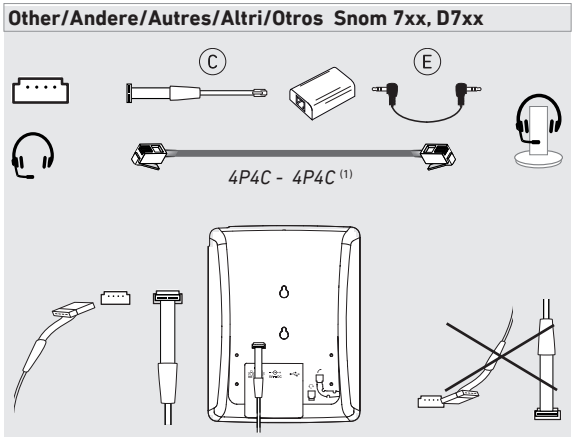
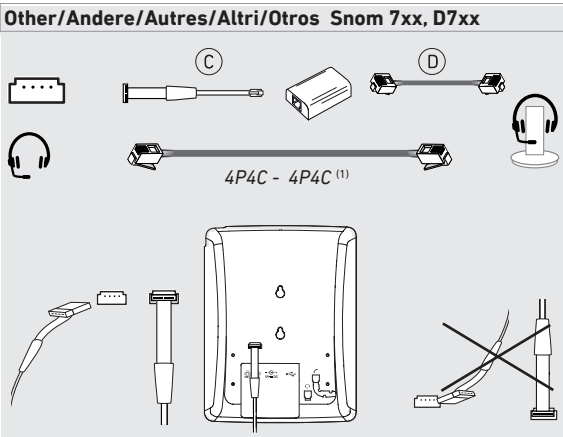
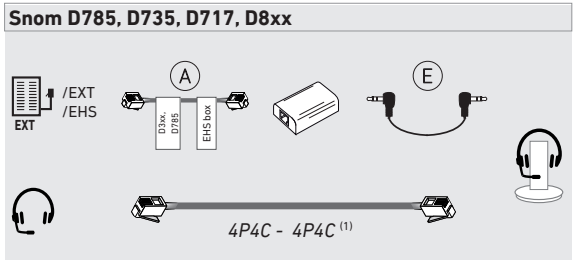
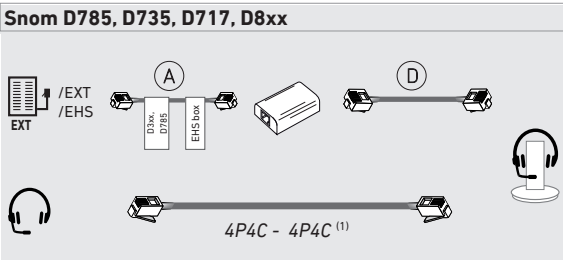
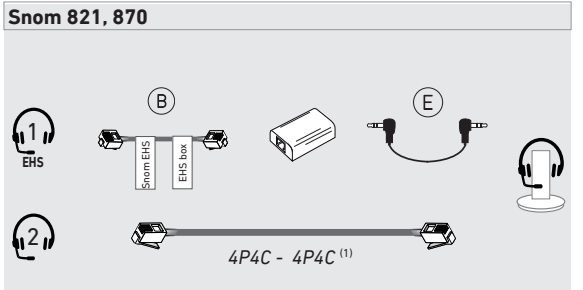
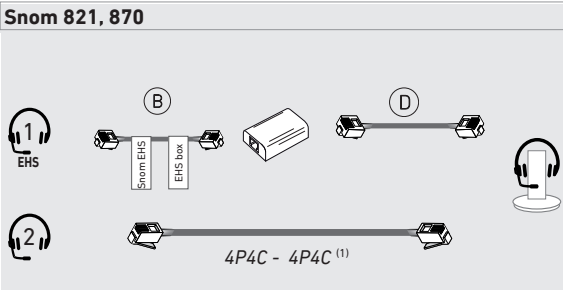
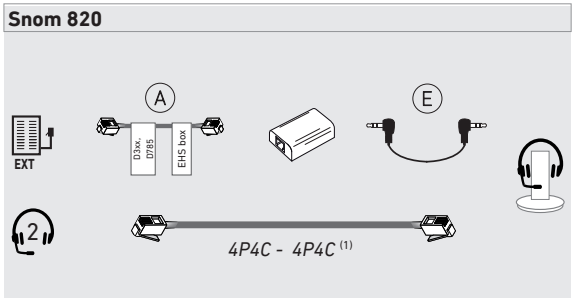
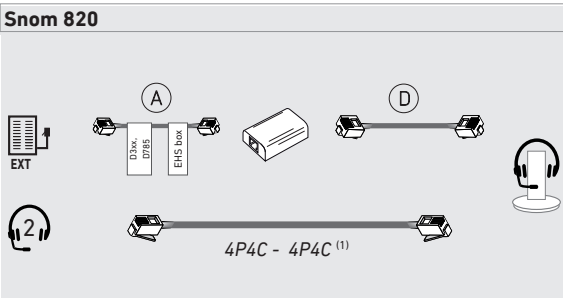
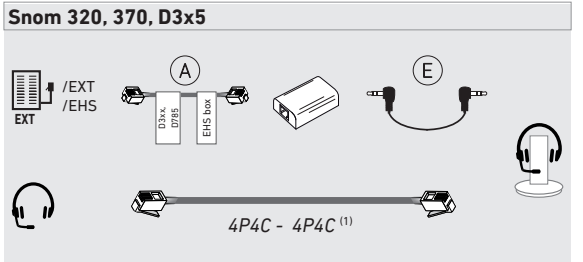
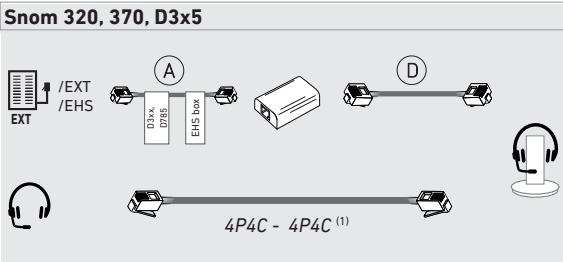
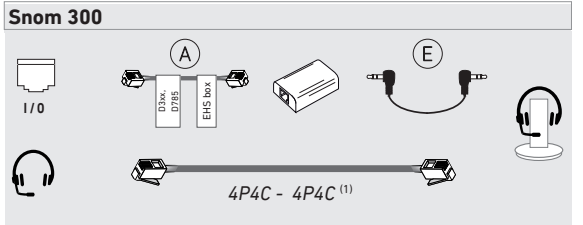
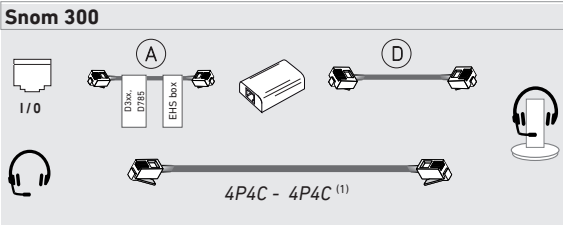

⁽¹⁾ Not included in delivery - Nicht im Lieferumfang enthalten - Non inclus - Non inclusos - No incluidos