

snom



## C620

SIP Wireless Conference Phone

Quick Installation Guide

# Quick Installation Guide

## C620

### SIP Wireless Conference Phone

#### Table of Contents

<b>Copyright, Trademarks, Legal Disclaimers</b>	<b>3</b>	<b>Change the default Administrator Password and User Password</b>	<b>13</b>
<b>Parts checklist</b>	<b>4</b>	<b>Factory reset the base station</b>	<b>14</b>
<b>Status Indicators Overview</b>	<b>5</b>	<b>Technical Specifications</b>	<b>15</b>
Multipurpose LED for conference phone and wireless mics.....	5	<b>California Energy Commission (CEC) battery charging testing instructions</b>	<b>16</b>
<b>Status indicators on the base station</b>	<b>6</b>	<b>Important Battery Information</b>	<b>17</b>
<b>Install the base station</b>	<b>7</b>	Charging and Discharging, Storage.....	17
<b>Install the conference phone battery</b>	<b>7</b>	Disposal of the device and batteries.....	17
<b>Connect power to the conference phone</b>	<b>8</b>	Cleaning.....	17
<b>Register the conference phone to the base</b>	<b>8</b>	<b>Important Safety Information</b>	<b>18</b>
<b>Deregister the conference phone</b>	<b>9</b>	Important safety instructions.....	18
<b>Install the wireless mic battery</b>	<b>10</b>	Battery.....	20
<b>Register the wireless mics to the base</b>	<b>11</b>	About wireless mics.....	20
<b>Deregister the wireless mics</b>	<b>11</b>	<b>For C-UL compliance only</b>	<b>21</b>
<b>Register a C52-SP DECT Expansion Speakerphone</b>	<b>12</b>	<b>Mesures de sécurité importantes</b>	<b>21</b>
Manually register the C52-SP to the C620.....	12	À propos des microphones sans fil.....	24
<b>Deregister a C52-SP DECT Expansion Speakerphone</b>	<b>12</b>	<b>Compliance</b>	<b>25</b>
		FCC part 15.....	25
		Industry Canada.....	26

# Copyright, Trademarks, Legal Disclaimers

© 2024 Snom Technology GmbH. All Rights Reserved.

Snom, the names of Snom products, and Snom logos are trademarks owned by Snom Technology GmbH.

All product specifications are subject to change without notification. Snom Technology GmbH. reserves the right to revise and change this document at any time, without being obliged to announce such revisions or changes beforehand or after the fact.

Although due care has been taken in the compilation and presentation of the information in this document, the data upon which it is based may have changed in the meantime. Snom therefore disclaims all warranties and liability for the accurateness, completeness, and currentness of the information published, except in the case of intention or gross negligence on the part of Snom or where liability arises due to binding legal provisions.

## Important Information

Please read the instructions on safety and disposal and on how to set up and use the device before using it and also give them to other users to read or inform those users of their contents. Save this manual and do not give the device to third parties without it.

# Parts checklist

Your product package contains the following items. Save your sales receipt and original packaging in the event warranty service is necessary.

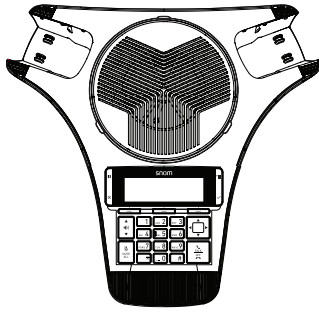
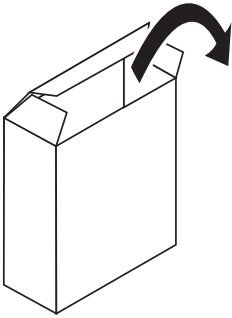

Conference Phone



Wireless Mic x2



Wireless Mic battery door x2



Wireless Mic battery x2

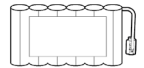

Conference Phone battery

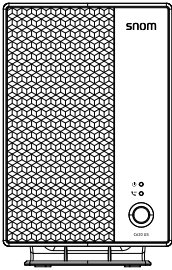

Base Station

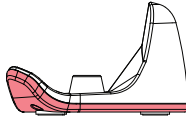

Charging Dock

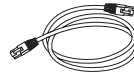

Ethernet cable



2 (two) screws for Conference Phone battery door



Screwdriver

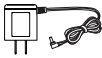

DC 5V 800mA power adapter for Base Station

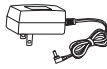

DC 12V 3A round jack power adapter for Charging Dock

**C620**

Quick  
Installation  
Guide

# Status Indicators Overview

## Multipurpose LED for conference phone and wireless mics

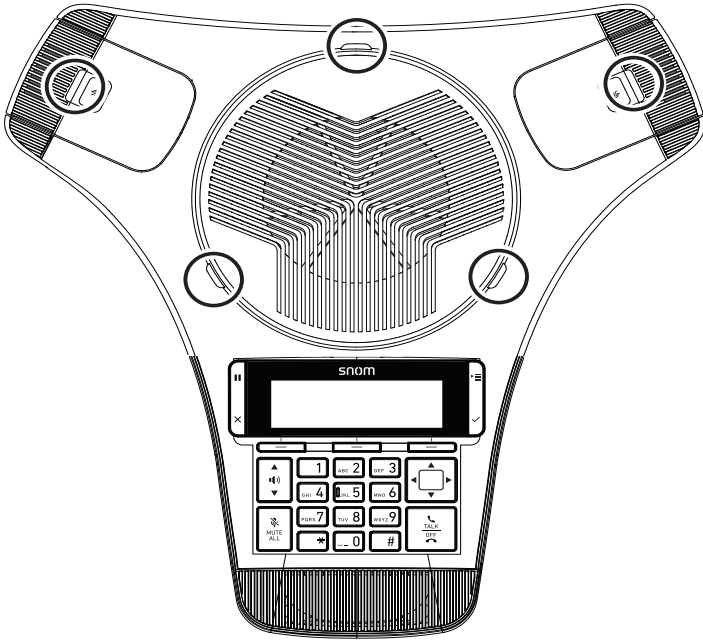

Power Up	<ul style="list-style-type: none"> <li>Steady Orange for five seconds.</li> </ul>
On a call	<ul style="list-style-type: none"> <li>Steady Green during a call.</li> <li>Steady Red when a call is muted, or if there are new messages.</li> </ul>
Incoming Call	<ul style="list-style-type: none"> <li>Flashes Green quickly when there is an incoming call.</li> </ul>
Charging	<ul style="list-style-type: none"> <li>Steady Orange while charging.</li> <li>Steady Orange for five seconds when charging completed and you connect the conference phone to the charging dock.</li> <li>Off when charging completed.</li> </ul>
Low Battery	<ul style="list-style-type: none"> <li>Flashes Orange slowly</li> </ul>
Stand by	<ul style="list-style-type: none"> <li>Off when DECT linked; conference phone is idling; audio mode is not in use.</li> </ul>
Registration	<ul style="list-style-type: none"> <li>Flashes Red and Green alternately when DECT registration in progress.</li> <li>Steady Green for five seconds when registration successful.</li> <li>Steady Red for five seconds when registration failed or canceled.</li> </ul>

Paged by base station	<ul style="list-style-type: none"> <li>Flashes Green slowly</li> </ul>
DECT Searching Mode	<ul style="list-style-type: none"> <li>Flashes Red slowly when out of range or not registered.</li> </ul>
Reset mode	<ul style="list-style-type: none"> <li>Steady Orange</li> </ul>
CEC battery charging testing mode	<ul style="list-style-type: none"> <li>Flashes Red</li> </ul>

## Status indicators on the base station

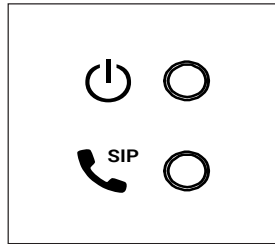

Power LED

VoIP LED

Power up	<ul style="list-style-type: none"> <li>Power LED is Steady Green.</li> </ul>
Power down	<ul style="list-style-type: none"> <li>Power LED is Off.</li> </ul>
Deregistration	<ul style="list-style-type: none"> <li>Power and VoIP LEDs flash Green quickly while ready to deregister devices.</li> <li>Power and VoIP LEDs are Steady Green for five seconds after the deregistration confirmation has elapsed.</li> <li>VoIP LED is Off when at least one SIP account is deregistered.</li> </ul>
Registration	<ul style="list-style-type: none"> <li>Power and VoIP LEDs alternately flash Green slowly when base negotiating or checking with provisioning server.</li> <li>Power and VoIP LEDs flash Green slowly during device registration.</li> <li>VoIP LED is Steady Green when no SIP account is unregistered.</li> </ul>
Firmware Upgrade	<ul style="list-style-type: none"> <li>Power and VoIP LEDs alternately flash Green quickly when firmware upgrade or configuration import in progress.</li> </ul>

## Install the base station

1. Plug one end of the Ethernet cable into the Ethernet port on the rear of the base station, and plug the other end of the cable into your network router or switch.
2. If the base station is not using power from a PoE-capable network router or switch:
  - Connect the provided DC 5V 800mA power adapter to the base station power jack.
  - Plug the power adapter into an electrical outlet that is not controlled by a wall switch.

### IMPORTANT INFORMATION

- Use only the DC 5V 800mA power adapter provided with the product. To order a replacement power adapter, visit our website at **[www.snomamericas.com](http://www.snomamericas.com)**.
- The power adapter is intended to be correctly oriented in a vertical or floor mount position. The prongs are not designed to hold the plug in place if it is plugged into a ceiling, under-the-table, or cabinet outlet.

## Install the conference phone battery



- Risk of explosion! Batteries should not be exposed to excessive heat such as bright sunlight or fire.
  - Use only the supplied battery
1. After removing the battery door, plug the battery connector securely into the socket inside the battery compartment.
  2. Place the battery into the battery compartment with the label **THIS SIDE UP** facing up.
  3. Attach the battery door, and secure it in place with the provided screws.

## Connect power to the conference phone



1. Plug the DC 12V 3A round jack end of the power adapter into the power jack on the back of the charging dock.
2. Plug the large end of the power adapter into a wall outlet not controlled by a switch.
3. Place the rear connectors of the conference phone into the charging dock.
  - The supplied DC 12V 3A round jack power adapter is designed for use only with the C620 conference phone. It is not designed to power other devices. Do not connect the supplied DC 12V 3A round jack power adapter to any other devices.
  - The DC 12V 3A round jack power adapter is intended to be correctly oriented in a vertical or floor mount position. The prongs are not designed to hold the plug in place if it is plugged into a ceiling, under-the-table, or cabinet outlet.

## Register the conference phone to the base

Your conference phone is pre-registered to the base station. If you need to manually re-register the conference phone, follow these steps:

1. Place the conference phone in the charging dock, and make sure it is connected to power.
2. If the conference phone is displaying  go to step 6.

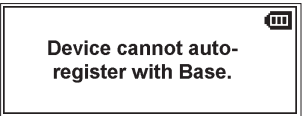

3. If the conference phone is displaying   go to step 7.

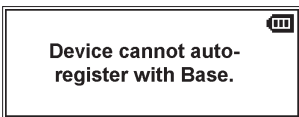

4. If the conference phone is displaying

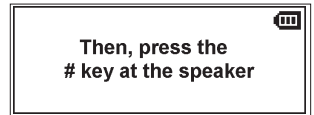
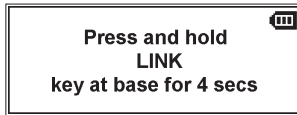
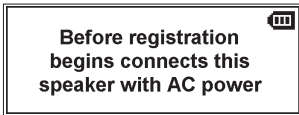

go to step 8.

5. If the conference phone is displaying  go to step 7.





6. Press **Cancel** .

The conference phone displays the following messages:

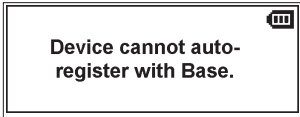

7. Press **Yes** .

The conference phone displays the following message:

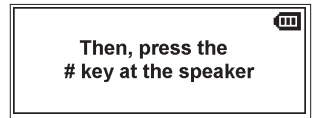
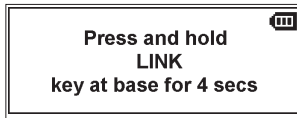
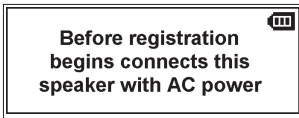

8. On the base station, press and hold the LINK key for 4 seconds. Both LEDs on the base station begin to flash.
9. Press the # key on the conference phone to begin registration. The conference phone displays the message "Registering... please wait." When registration is complete, the conference phone beeps and then displays "Speaker Registered."

If the conference phone fails to register, remove it from the charger for a few seconds, replace it in the charger, and repeat the registration procedure.

## Deregister the conference phone

1. Press  (MENU).
2. Select **Status & Settings > User Settings > Registration**.
3. Select **Deregistration**.
4. Select the <device name> of the conference phone. For example, "SPEAKERBOX 1".
5. Enter the PIN. Default PIN is 1590.

If deregistration is successful, the conference phone displays a message. For example, "SPEAKER BOX 1 is deregistered."

## Install the wireless mic battery

1. Plug the battery connector securely into the socket inside the battery compartment. Insert the battery (with the label **THIS SIDE UP** facing up) into the battery compartment.
2. Slide the battery door until it clicks into place.
3. Place the wireless mic into the charging cradles until they are flush.

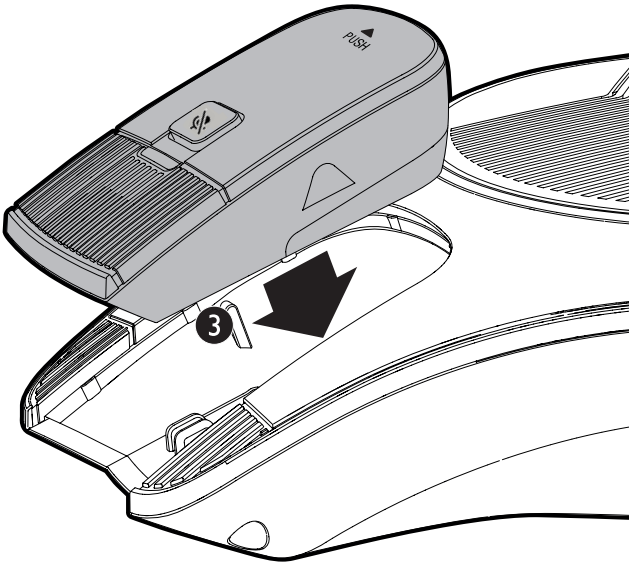
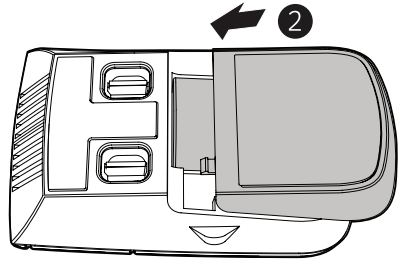
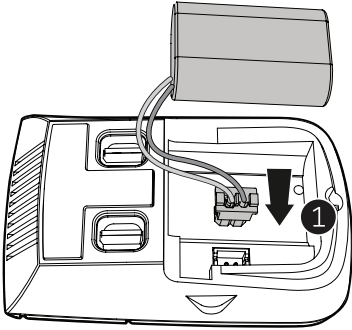

**NOTE:** The status indicator on the wireless mic turns orange when charging, and turns off when the wireless mic is fully charged.



## Register the wireless mics to the base

Your wireless mics are pre-registered to the base station.

If you need to manually re-register the wireless mics, follow these steps:

1. Press  (MENU).
2. Select **Status & Settings > User Settings > Registration**.
3. Select **Wireless microphone**.
4. Select **with Base station**.
5. Follow the instructions on the conference phone screen.  
Press **NEXT** to move through the screens.
  - a. Connect the conference phone with AC power.
  - b. Put one wireless mic on the conference phone charge cradle
  - c. Press and hold the LINK key on the base station for 4 seconds.
  - d. Press and hold the  key on the wireless mic for 3 seconds.  
If registration is successful, the mic LED lights up in green for 5 seconds  
If registration is unsuccessful, the mic LED lights up in red for 5 seconds.
6. To register the second wireless mic, repeat step 4 to 5.

## Deregister the wireless mics

1. Press  (MENU).
2. Select **Status & Settings > User Settings > Registration**.
3. Select **Deregistration**.
4. On the Deregistration screen, select the wireless microphone you want to deregister.
5. Enter the PIN. Default PIN is 1590.  
If deregistration is successful, the conference phone displays a message.  
For example, "MICROPHONE 3" is deregistered."
6. To deregister another wireless mic, go to step 3.

# Register a C52-SP DECT Expansion Speakerphone

You can register up to two C52-SP DECT Expansion Speakerphones to your C620 SIP Wireless Conference Phone.

## If your organization uses DECT auto registration:

The C52-SP will automatically register to the C620. You do not need to take any further action.

## If your organization does NOT use DECT auto registration (or if you are not sure):

You must first turn off auto registration on the C52-SP by performing the following steps:

1. Press and hold the **MUTE ALL** button on the C52-SP for five seconds.
2. Press and hold the **TALK/OFF** button on the C52-SP for five seconds.

The C52-SP LEDs turn steady orange for five seconds, then slowly flash orange.

At this point, you can manually register the C52-SP to the C620 by following the instructions below.



## Manually register the C52-SP to the C620

---

1. Press and hold the REGISTRATION button on the bottom of the C52-SP unit for five seconds.

When you release the button, the C52-SP LEDs will flash red and green alternately. This indicates the C52-SP is ready for registration.

2. Press and hold the LINK key on the C620 base unit for four seconds.

The  and  LEDs flash green for about 10 seconds, then turn steady green.

If registration is successful, the LEDs on the C52-SP turn green for five seconds.

If registration fails, the LEDs on the C52-SP turn red for five seconds.

3. To register an additional C52-SP speakerphone, follow the instructions in "Register a C52-SP DECT Expansion Speakerphone", at the top of this page.

# Deregister a C52-SP DECT Expansion Speakerphone

1. Press  (MENU).
2. Select **Status & Settings > User Settings > Registration**.
3. Select **Deregistration**.
4. On the Deregistration menu, select **WIRELESS SPE**.
5. Enter the PIN. Default PIN is 1590.

The conference phone displays the message "WIRELESS SPE X is deregistered."

# Change the default Administrator Password and User Password

You must change the Administrator Password and User Password of the C620 SIP Wireless Conference Phone in order to access its WebUI pages.

The conference phone will display a warning message until you change both passwords.

For security reason,  
please edit the  
User PW  
Admin PW

**NOTE:** You can press  on the conference phone to temporarily clear the warning message and display the idle screen. After 15 minutes, the warning message reappears.

## To change the Administrator Password and User Password:

1. On the conference phone, press  (MENU) and select **Status & Settings > Status > Network > IPv4 or IPv6**.
2. Press  to scroll down to display the **IP Address**.
3. Enter the IP address in the address bar of a web browser and press ENTER. The Passwords page of the C620 WebUI appears.

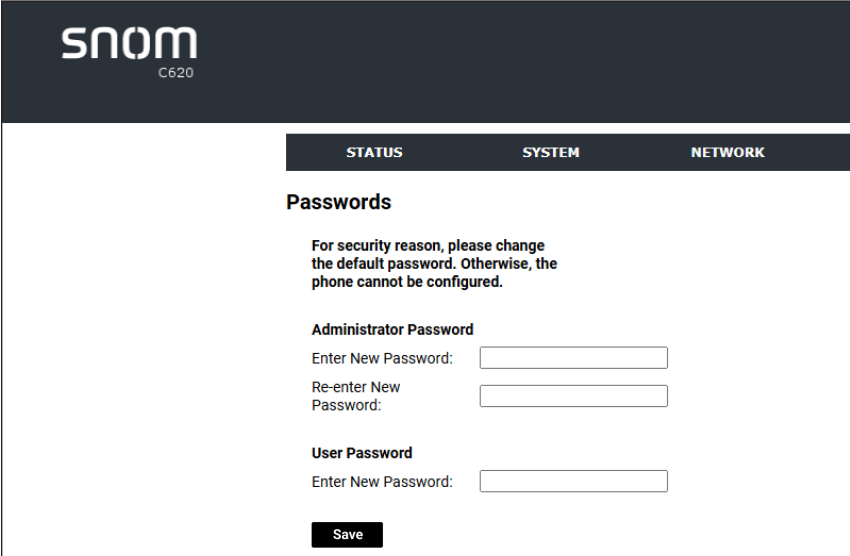

**SNOM**  
C620

STATUS SYSTEM NETWORK

### Passwords

For security reason, please change the default password. Otherwise, the phone cannot be configured.

**Administrator Password**  
Enter New Password:   
Re-enter New Password:

**User Password**  
Enter New Password:

Save

4. Enter and re-enter a new Administrator Password.
5. Enter a new User Password.
6. Click **Save**.  
The WebUI page refreshes. You can now open pages on the WebUI.

## Factory reset the base station

1. Using a paperclip, or something similar, press and hold the reset button on the back of the base station for 15 seconds.
2. Release the reset button. During the next one to two minutes, the following occurs:
  - The conference phone displays "Please wait".
  - The VoIP LED on the base station flashes quickly, then the Power LED and the VoIP LED flash alternately.
  - The conference phone beeps once and displays "Out of range or no power at base".
  - The status indicators on the conference phone flash red quickly.
  - The conference phone displays the idle screen. This indicates the factory reset has completed.

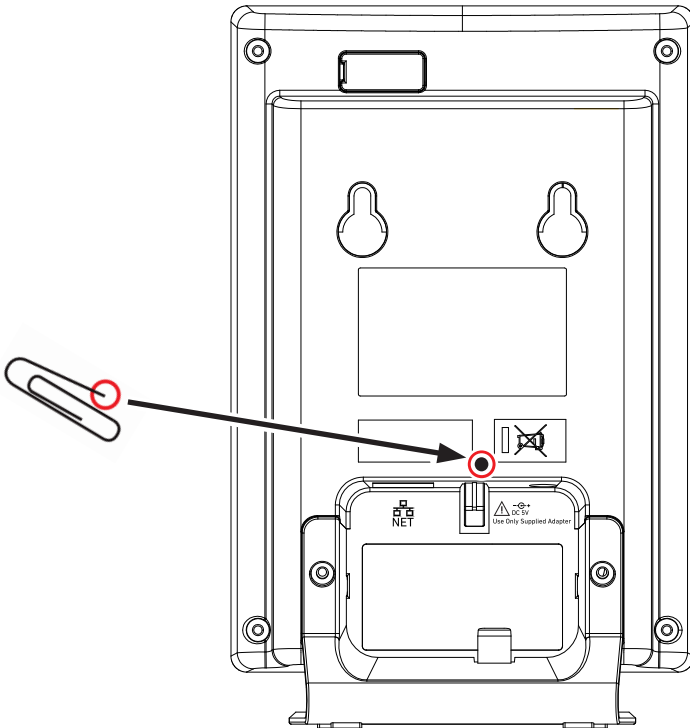

# Technical Specifications

Connector	1 x RJ45 (Ethernet) - LAN	
Ethernet	10/100 MB	
Power requirements	Base Unit	Power over Ethernet (PoE): IEEE 802.3af, Class 2
		If PoE not available: Power adapter (included in delivery): Model number: NBS12E050200UV Input: 100-240V AC 50/60Hz 0.3A Output: 5V DC 2.0A -OR- Model number: S006AKU0500080 Input: 100-240V AC 50/60Hz Output: 5.0V DC 800mA
	Conference Phone	Battery: (BT200660) 7.2V 4000mAh Ni-MH
		Charging dock power adapter: Model number: S042-1A120300VU Input: 100-240V AC 50/60Hz 1.0A Output: 12V DC 3.0A -OR- Model number: CS36M120300FUF Input: 100-240V AC 50/60Hz Output: 12V DC 3.0A
Wireless Mics	Battery: (BT183642/BT283642) 2.4V, 400mAh Ni-MH	
Optimal distance between conference phone or wireless mic and participant: 60 cm (24 inches)		
Minimum distance between microphones: 30 cm (12 inches)		

# California Energy Commission (CEC) battery charging testing instructions

This telephone is set up to comply with the energy-conserving standards right out of the box. These instructions are intended for CEC compliance testing only. When the CEC battery charging testing mode is activated, all telephone functions, except battery charging, will be disabled.

These instructions assume that all devices have been registered to the base unit before activating this test mode.

## To activate the CEC battery charging testing mode:

1. Remove the conference phone from the charging dock.
2. Remove the battery from the conference phone.
3. Press and hold **MUTE ALL** on the conference phone.
4. With the **MUTE ALL** key pressed, insert the battery in the conference phone, and then wait for 5 seconds.
5. When the conference phone status indicators start flashing red, release **MUTE ALL**, and then press **MUTE ALL** immediately.

The conference phone displays the message:

"To use the phone again, please reset the power."

6. Put the conference phone on the charging dock to charge the conference phone battery.

The battery icon  indicates the charge status as the battery charges.

## To deactivate the CEC battery charging testing mode:

1. Remove the conference phone from the charging dock.
2. Remove the battery from the conference phone.
3. Reinsert the battery in the conference phone without pressing any keys.



# Important Battery Information

The detachable wireless microphones of this product use rechargeable 2.4V 400mAh Ni-MH batteries. The conference phone uses rechargeable 7.2V 4000mAh Ni-MH batteries. Use only the batteries that came with the product or contact Snom if you need replacement batteries. Contact information is available at [www.snomamericas.com](http://www.snomamericas.com). Do not use any other type of battery since this may lead to leakage, fire, explosion, or other dangerous situations.

Never disassemble, alter, or short-circuit batteries or use them for purposes other than the intended one. Charge batteries only within the detachable wireless microphones placed in the chargers on the product.

---

## Charging and Discharging, Storage

- The full performance of a new batteries is achieved only after two or three complete charge and discharge cycles.
- The batteries can be charged and discharged hundreds of times, but they will eventually wear out. Contact Snom if you need to replace the batteries. Contact information is available at [www.snomamericas.com](http://www.snomamericas.com).
- If left unused, a fully charged battery will lose its charge over time.
- Use the batteries only for their intended purpose. Do not short-circuit the batteries. Short-circuiting the terminals may damage the batteries or the connecting object. Do not use a damaged charger or battery. Using a damaged battery may cause it to explode.
- Do not place or store the batteries, inside or outside the microphone, in the immediate vicinity of open fire or other heat sources.
- Leaving the batteries in hot or cold places will reduce their capacity and lifetime. Charge batteries within an ambient temperature range of +5° C to +40° C (+41° F to +104° F), max. humidity 85%. A device with a hot or cold battery may not work temporarily, even when the battery is fully charged.
- Avoid overcharging. Repeated overcharging can lead to deterioration in batteries performance. Never attempt charging the batteries with reversed polarity as this may cause the gas pressure inside the batteries to rise and lead to leakages.
- Remove batteries if storing product for more than 1 month.
- Store batteries in a cool, dry place without corrosive gases. Temperature range for storage of charged batteries up to 6 months: -20° C to +45° C (-4° F to 113° F); up to 2 years: -20° C to +35° C (-4° F to 95° F); humidity 65±20%. Discharge and charge batteries every 3 months.

---

## Disposal of the device and batteries

Disposal of electrical and electronic products and batteries should be done in line with local regulations. Please contact local authorities for further information.

---

## Cleaning

To clean the device, use an anti-static cloth. Please avoid cleaning liquids as they might damage the surface or internal electronics of the device.

# Important Safety Information



This symbol is to alert you to important operating or servicing instructions that may appear on the product or in this user's manual. Always follow basic safety precautions when using this product to reduce the risk of injury, fire, or electric shock.

## Important safety instructions

---

When using your C620 SIP Wireless Conference phone, basic safety precautions should always be followed to reduce the risk of fire, electric shock and injury to persons, including the following:

1. This product should be installed by a qualified technician.
2. This product should only be connected to the host equipment and never directly to the network such as Public Switch Telephone Network (PSTN) or Plain Old Telephone Services (POTS).
3. Read and understand all instructions.
4. Follow all warnings and instructions marked on the product.
5. Unplug this product from the wall outlet before cleaning. Do not use liquid or aerosol cleaners. Use a damp cloth for cleaning.
6. Do not use this product near water such as near a bathtub, wash bowl, kitchen sink, laundry tub or swimming pool, or in a wet basement or shower.
7. Do not place this product on an unstable table, shelf, stand or other unstable surfaces.
8. Slots and openings in the back or bottom of the base unit and wireless mic are provided for ventilation. To protect them from overheating, these openings must not be blocked by placing the product on a soft surface such as a bed, sofa or rug. This product should never be placed near or over a radiator or heat register. This product should not be placed in any area where proper ventilation is not provided.
9. This product should be operated only from the type of power source indicated on the marking label. If you are not sure of the type of power supply in your office, consult your dealer or local power company.
10. Do not allow anything to rest on the power cord. Do not install this product where the cord may be walked on.
11. Never push objects of any kind into this product through the slots in the base unit or wireless mic because they may touch dangerous voltage points or create a short circuit. Never spill liquid of any kind on the product.
12. To reduce the risk of electric shock, do not disassemble this product, but take it to an authorized service facility. Opening or removing parts of the base unit or wireless mic other than specified access doors may expose you to dangerous voltages or other risks. Incorrect reassembling can cause electric shock when the product is subsequently used.
13. Do not overload wall outlets and extension cords.

14. Unplug this product from the wall outlet and refer servicing to an authorized service facility under the following conditions:
  - A. When the power supply cord or plug is damaged or frayed.
  - B. If liquid has been spilled onto the product.
  - C. If the product has been exposed to rain or water.
  - D. If the product does not operate normally by following the operating instructions. Adjust only those controls that are covered by the operation instructions. Improper adjustment of other controls may result in damage and often requires extensive work by an authorized technician to restore the product to normal operation.
  - E. If the product has been dropped and the base unit and/or wireless mic has been damaged.
  - F. If the product exhibits a distinct change in performance.
15. Avoid using the C620 SIP Wireless Conference phone during an electrical storm. There is a remote risk of electric shock from lightning.
16. Do not use the C620 SIP Wireless Conference phone to report a gas leak in the vicinity of the leak. Under certain circumstances, a spark may be created when the adapter is plugged into the power outlet, or when the wireless mic is replaced in its cradle. This is a common event associated with the closing of any electrical circuit. The user should not plug the phone into a power outlet, and should not put a charged wireless mic onto the charging cradle, if the phone is located in an environment containing concentrations of flammable or flame-supporting gases, unless there is adequate ventilation. A spark in such an environment could create a fire or explosion. Such environments might include: medical use of oxygen without adequate ventilation; industrial gases (cleaning solvents; gasoline vapors; etc.); a leak of natural gas; etc.
17. Only put the wireless mic next to your mouth when it is in normal talk mode.
18. The power cables are intended to be correctly oriented in a vertical or floor mount position. The prongs are not designed to hold the plug in place if it is plugged into a ceiling or cabinet outlet.
19. Use only the adapter included with this product. Incorrect adapter polarity or voltage can seriously damage the product.
20. For pluggable equipment, the socket-outlet shall be installed near the equipment and shall be easily accessible.
21. In wall mounting position, make sure to mount the telephone base on the wall by aligning the eyelets with the mounting studs of the wall plate. Then slide the telephone base down on both mounting studs until it locks into place. Refer to the full installation instructions in the User Manual.
22. **CAUTION:** Keep small metallic objects such as pins and staples away from the handset receiver.

23. **CAUTION:** Use only the batteries indicated in this manual. There may be a risk of explosion if a wrong type of battery is used. Use only the supplied rechargeable battery or replacement battery pack. Do not dispose of batteries in a fire. They may explode. Dispose of used battery according to the information in The RBRC® seal.
24. **WARNING:** The product included (ITE) in this manual is to be connected only to PoE networks without routing to the outside plant.

## SAVE THESE INSTRUCTIONS

### Battery

---

- **CAUTION:** Use Only Supplied Battery.
- Do not dispose of the battery in a fire. Check with local waste management codes for special disposal instructions.
- Do not open or mutilate the battery. Released electrolyte is corrosive and may cause burns or injury to the eyes or skin. The electrolyte may be toxic if swallowed.
- Exercise care in handling batteries in order not to create a short circuit with conductive materials.
- Charge the battery provided with or identified for use with this product only in accordance with the instructions and limitations specified in this manual.

### About wireless mics

---

- **Privacy:** The same features that make a wireless mic convenient create some limitations. Calls on conference phones are transmitted between the base unit and the wireless mic by radio waves, so there is a possibility that the wireless mic conversations could be intercepted by radio receiving equipment within range of the wireless mic. For this reason, you should not think of conference phone conversations as being as private as those on corded telephones.
- **Electrical power:** The base unit of this conference phone must be connected to a working electrical outlet. The electrical outlet should not be controlled by a wall switch. Calls cannot be made from the conference phone if the base unit is unplugged, switched off or if the electrical power is interrupted.
- **Potential TV interference:** Wireless mic operates at frequencies that may cause interference to televisions and VCRs. To minimize or prevent such interference, do not place the base unit near or on top of a TV or VCR. If interference is experienced, moving the wireless mic farther away from the TV or VCR often reduces or eliminates the interference.
- **Rechargeable batteries:** Exercise care in handling batteries in order not to create a short circuit with conducting material such as rings, bracelets and keys. The battery or conductor may overheat and cause harm.
- **Nickel-metal hydride rechargeable batteries:** Dispose of these batteries in a safe manner. Do not burn or puncture. Like other batteries of this type, if burned or punctured, they could release caustic material which could cause injury.

## For C-UL compliance only

### Mesures de sécurité importantes



Ce symbole vous alertera d'informations importantes ou d'instructions d'entretien pouvant apparaître dans ce guide d'utilisation. Respectez toujours les mesures de sécurité et de sécurité de base lorsque vous utilisez ce produit, afin de réduire les risques de blessures, d'incendie, ou d'électrocution.

#### Mesures de sécurité importantes

---

Vous devez toujours observer des mesures de précaution lorsque vous utilisez le Téléphone de conférence à protocole d'initialisation de session SIP C620, afin d'éviter les risques d'incendie, d'électrocution et de blessures, incluant ce qui suit :

1. Cet appareil doit être installé par un technicien qualifié.
2. Cet appareil doit être branché à un équipement hôte et jamais branché à un réseau, tel qu'un réseau PSTN publique ou un réseau téléphonique standard (POTS).
3. Lisez et comprenez bien toutes les instructions.
4. Observez toutes les instructions et mises en garde inscrites sur l'appareil.
5. Débranchez ce téléphone de la prise murale avant de le nettoyer. N'utilisez pas de nettoyeurs liquides ni en aérosol. N'utilisez qu'un chiffon doux et légèrement humecté.
6. N'utilisez pas ce produit près de l'eau, tel que près d'un bain, d'un lavabo, d'un évier de cuisine, d'un bac de lavage ou d'une piscine, ou dans un sous-sol humide ou sous la douche.
7. Ne déposez pas ce téléphone sur un chariot, support ou table chancelants. L'appareil pourrait tomber et être sérieusement endommagé.
8. Les ouvertures situées à l'arrière ou sous le socle et le microphone sans fil servent à la ventilation. Afin d'empêcher la surchauffe, ces ouvertures ne doivent pas être obstruées en plaçant l'appareil sur un lit, divan, tapis ou autre surface similaires. Ne placez pas cet appareil à proximité d'un élément de chauffage ni d'une plinthe électrique. De plus, ne l'installez pas dans une unité murale ou un cabinet fermé qui ne possède pas d'aération adéquate.
9. Ne faites fonctionner cet appareil qu'avec le type d'alimentation indiqué sur les étiquettes de l'appareil. Si vous ne connaissez pas le voltage de votre maison, consultez votre marchand ou votre fournisseur d'électricité.
10. Ne déposez rien sur le cordon d'alimentation. Installez cet appareil dans un endroit sécuritaire, là où personne ne pourra trébucher sur la ligne d'alimentation ni le cordon téléphonique modulaire.
11. N'enfoncez jamais d'objets dans les fentes du socle ou du microphone sans fil, car ceci risquerait d'entrer en contact avec des points de tension dangereux ou

- provoquer un court-circuit. N'échappez pas de liquides dans l'appareil.
12. Afin de réduire les risques d'électrocution, ne démontez pas l'appareil, mais apportez-le plutôt à un centre de service qualifié s'il doit être réparé. L'ouverture ou le retrait de pièces du socle ou du microphone sans fil autre que les portes d'accès peuvent vous exposer à des tensions dangereuses et à d'autres risques. Débranchez l'appareil avant de procéder au nettoyage. Utilisez un chiffon humide et doux.
  13. Ne surchargez pas les prises de courant et les rallonges.
  14. Débranchez cet appareil de la prise de courant et communiquez avec le département de service à la clientèle de Snom dans les cas suivants :
    - A. Lorsque le cordon d'alimentation est endommagé ou écorché.
    - B. Si du liquide a été échappé dans l'appareil.
    - C. Si l'appareil a été exposé à une source d'humidité telle que la pluie ou l'eau.
    - D. Si le produit ne fonctionne pas normalement en respectant les instructions de fonctionnement. Réglez uniquement les commandes indiquées dans les instructions de fonctionnement. Les réglages incorrects des autres commandes pourraient provoquer un dommage qui pourrait exiger un travail exhaustif de la part d'un technicien autorisé afin de rétablir le fonctionnement normal de l'appareil.
    - E. Si le produit a été échappé et que le socle et/ou le microphone sans fil a été endommagé.
    - F. Si le produit affiche une nette diminution de sa performance.
  15. Évitez d'utiliser le Téléphone de conférence à protocole d'initialisation de session SIP C620 pendant un orage.
  16. N'utilisez pas le Téléphone de conférence à protocole d'initialisation de session SIP C620 pour rapporter une fuite de gaz à proximité de la fuite. En certaines circonstances, une flammèche pourrait être provoquée lorsque l'adaptateur est branché dans une prise de courant ou lorsque le microphone auxiliaire est déposé sur son socle. Ceci est un événement commun associé à la fermeture d'un circuit électrique. L'utilisateur ne doit pas brancher le téléphone dans une prise de courant ni insérer un microphone sans fil rechargé dans le socle, si le téléphone se trouve dans un environnement contenant des concentrations de matières inflammables ou autres gaz susceptibles de produire des flammes, sauf en présence d'une aération adéquate. Une flammèche dans un tel endroit pourrait provoquer un incendie ou une explosion. De tels environnements peuvent comprendre: des endroits où l'on utilise de l'oxygène médical sans ventilation adéquate; des gaz industriels (dissolvants de nettoyage, des vapeurs d'essence, etc.); une fuite de gaz naturel, etc.
  17. Ne déposez que le microphone sans fil près de votre oreille que lorsqu'il est en mode de conversation normale.
  18. Ces adaptateurs ont été conçus pour être orientés en position verticale ou montés au sol. Les broches ne sont pas conçues pour maintenir l'adaptateur en place si celui-ci est branché dans une prise au plafond ou sous une table/ armoire.

19. N'utilisez que les adaptateurs inclus avec ce produit. L'utilisation d'un adaptateur dont la polarité ou la tension serait inadéquate risque d'endommager sérieusement le produit et mettre votre sécurité en péril.
20. Pour les PRODUITS À BRANCHER À UNE PRISE DE COURANT, la prise de courant doit être installée près du produit, afin d'assurer une accessibilité sécuritaire à la prise de courant.
21. En position de montage mural, assurez-vous de monter le socle du téléphone sur le mur en alignant les œillets avec les goujons de fixation de la plaque murale. Ensuite, faites glisser le socle vers le bas sur les deux goujons de fixation jusqu'à ce qu'il se verrouille en place. Reportez-vous aux instructions complètes dans la section Installation dans ce guide d'utilisation.
22. MISE EN GARDE : Éloignez les petits objets métalliques tels que les broches de l'écouteur du combiné.
23. MISE EN GARDE : Il peut y avoir un risque d'explosion si vous utilisez le mauvais type de piles. N'utilisez que le bloc-piles rechargeable inclus ou le bloc-piles de rechange. N'incinerez pas les piles. Celles-ci risqueraient d'exploser. Jetez les piles usées selon les renseignements suivant le sceau du RBRC<sup>MD</sup>.
24. AVERTISSEMENT : Le produit inclus (ITE) dans ce guide doit être connecté uniquement aux réseaux PoE sans être acheminé vers l'installation extérieure.

## **CONSERVEZ CES INSTRUCTIONS**

## Pile

---

- **MISE EN GARDE :** N'utilisez que la pile incluse.
- Ne jetez pas la pile au feu. Vérifiez les instructions spécifiques de mise aux rebus auprès des autorités locales.
- N'ouvrez pas et ne mutilez pas la pile. L'électrolyte qui s'en échapperait est corrosif et pourrait causer des brûlures ou des blessures aux yeux ou à la peau. L'électrolyte est toxique si avalé.
- Soyez prudents lorsque vous manipulez les piles afin d'éviter les courts-circuits provoqués par des matériaux conducteurs.
- Rechargez la pile incluse avec cet appareil, selon les instructions et limites spécifiées dans ce guide d'utilisation.

## À propos des microphones sans fil

---

- **Confidentialité:** Les mêmes caractéristiques qui constituent des avantages pour les téléphones sans fil affichent également des restrictions. Les appels téléphoniques sur les téléphones conférence sans fil sont transmis entre le combiné sans fil et le socle par le biais d'ondes radio ; il y a donc la possibilité que vos conversations téléphoniques sans fil soient interceptées par des équipements de réception radio se trouvant dans la portée du combiné sans fil. Pour cette raison, vous ne devez pas percevoir les communications sur les téléphones conférence sans fil comme étant aussi confidentielles que celles des téléphones à cordons.
- **Alimentation électrique:** Le socle de ce téléphone conférence sans fil doit être branché à une prise électrique fonctionnelle. La prise électrique ne doit pas être contrôlée par un interrupteur mural. Les appels ne pourront pas être effectués du téléphone conférence sans fil si le socle est débranché ou mis hors tension ou si le courant est interrompu.
- **Possibilité d'interférences aux téléviseurs:** Certains microphones sans fil sans fil fonctionnent sur des fréquences pouvant causer des interférences aux téléviseurs et aux magnétoscopes. Pour réduire ou prévenir de telles interférences, ne placez pas le socle du téléphone sans fil à proximité ou sur un téléviseur ou magnétoscope. S'il y a présence de parasites, il est conseillé d'éloigner le téléphone sans fil du téléviseur ou du magnétoscope afin de réduire possiblement les interférences.
- **Piles rechargeables:** Manipulez les piles avec soin afin de ne pas les court-circuiter avec des bagues, bracelets ou clés. Les piles ou le conducteur peut surchauffer et causer des blessures.
- **Les bloc-piles rechargeables à l'hydruure métallique de nickel:** Jetez ces blocs-piles de manière écologique et sécuritaire. Ne les incinerez pas et ne les percez pas. Tel que les autres piles de ce type, elles pourraient dégager une matière toxique qui peut causer des blessures corporelles si elles sont brûlées ou percées.



# Compliance

## FCC part 15

---

This device complies with Part 15 of the FCC rules. Operation is subject to the following two conditions: (1) This device may not cause harmful interference, and (2) this device must accept any interference received, including interference that may cause undesired operation.

This equipment has been tested and found to comply with the limits for a Class B digital device, pursuant to Part 15 of the FCC rules. These limits are designed to provide reasonable protection against harmful interference in residential installation. This equipment generates, uses and can radiate radio frequency energy and, if not installed and used in accordance with the instructions, may cause harmful interference to radio communications. However, there is no guarantee that interference will not occur in a particular installation; if this equipment does cause harmful interference to radio or television reception, which can be determined by turning the equipment off and on, you are encouraged to try to correct the interference by one of the following measures:

- Reorient or relocate the receiving television or radio antenna.
- Increase the separation between the telephone equipment and the receiver.
- Connect the telephone equipment into an outlet on a circuit different from that to which the television, radio or other receiver is connected.
- Consult the dealer or an experienced Radio/TV Technician for help.

Privacy of communications may not be ensured when using this phone.

**Warning:** Changes or modifications to this equipment not expressly approved by the party responsible for compliance could void the user's authority to operate the equipment.

**Caution:** To maintain the compliance with the FCC's RF exposure guideline, place the base unit at least 20 cm from nearby persons.

The C620 base station has been tested and meets the FCC RF exposure guidelines when used with the accessories supplied or designated for this product. Use of other accessories may not ensure compliance with FCC RF exposure guidelines.

## Industry Canada

---

This Class B digital apparatus complies with Canadian requirements: CAN ICES-3 (B)/NMB-3(B). Cet appareil numérique de la classe B est conforme à la norme CAN ICES-3 (B)/NMB-3(B) du Canada.

This device contains licence-exempt transmitter(s)/receiver(s) that comply with Innovation, Science and Economic Development Canada's licence-exempt RSS(s).

Operation is subject to the following two conditions: (1) this device may not cause interference, and (2) this device must accept any interference, including interference that may cause undesired operation of the device.

Privacy of communications may not be ensured when using this telephone.

The term "IC:" before the certification/registration number only signifies that the Industry Canada technical specifications were met.

This product meets the applicable Innovation, Science and Economic Development Canada technical specifications.



