

snom



# C620

SIP Wireless Conference Phone

User Manual

EU/UK/AU

# Copyright, Trademarks, Legal Disclaimers

© 2024 Snom Technology GmbH. All Rights Reserved.

Snom, the names of Snom products, and Snom logos are trademarks owned by Snom Technology GmbH.

All product specifications are subject to change without notification. Snom Technology GmbH. reserves the right to revise and change this document at any time, without being obliged to announce such revisions or changes beforehand or after the fact.

Although due care has been taken in the compilation and presentation of the information in this document, the data upon which it is based may have changed in the meantime. Snom therefore disclaims all warranties and liability for the accurateness, completeness, and currentness of the information published, except in the case of intention or gross negligence on the part of Snom or where liability arises due to binding legal provisions.

## Important Information

Please read the instructions on safety and disposal and on how to set up and use the device before using it and also give them to other users to read or inform those users of their contents. Save this manual and do not give the device to third parties without it.

# Table of contents

Introduction .....	1	Redialing a call.....	19
About the C620 SIP Wireless Conference phone .....	1	Adjusting call volume .....	19
Introduction .....	2	Muting active calls.....	19
Parts checklist.....	2	Temporarily silencing the ringer.....	20
Getting started .....	3	Putting a call on hold.....	20
Installing the base station.....	3	Transferring calls.....	21
Installing the conference phone battery 3		Making a conference call.....	23
Connecting power to the conference phone .....	3	Setting up a network conference .....	25
Installing the wireless mic battery .....	4	Retrieving messages.....	25
Conference phone overview .....	5	Paging.....	27
Wireless mic overview.....	7	Directory.....	28
Base unit overview (front).....	8	About the directory .....	28
Status indicators on the conference phone / wireless mics .....	9	Viewing a directory .....	28
Status indicators on the base station..	11	Adding a directory entry.....	29
Idle screen.....	12	Reviewing directory entries.....	30
Idle mode screen icons.....	12	Searching for a directory entry.....	30
Active call screen icons .....	12	Dialing a directory entry .....	30
Using the Main Menu .....	13	Editing a directory entry .....	31
Main menu items.....	13	Deleting a directory entry.....	31
Input Modes .....	14	Deleting all directory entries.....	32
Entering numerals, letters, and symbols 14		Call History .....	33
Conference phone operation .....	16	Call history .....	33
Making calls.....	16	Reviewing call history .....	33
Using a wireless microphone during a call .....	17	Dialing a call history entry .....	34
Ending the call.....	17	Saving a call history entry to the directory.....	34
Answering a call.....	17	Deleting a call history entry.....	35
Call waiting.....	18	Deleting all call history entries.....	35
Missed calls .....	18	Speed dial .....	36
		Speed dial.....	36
		Dialing a speed dial number.....	36
		Adding a speed dial entry.....	36
		Editing a speed dial entry.....	36

# Table of contents

Deleting a speed dial entry .....	37	Conference phone battery .....	56
Settings.....	38	Charging .....	56
Call Features Menu.....	38	Battery disposal.....	56
Call Features menu items.....	38	Factory reset the base station.....	57
Setting Do Not Disturb (DND).....	39	Troubleshooting .....	58
Setting Call Forwarding.....	39	Important information .....	62
Setting Block Anonymous .....	41	Important safety instructions.....	62
Setting Dial as Anonymous.....	41	Standards conformance.....	62
Setting Missed Call Alert .....	42	Technical specifications.....	63
Setting Call Waiting alert .....	42	Important battery information,,	63
To set call waiting alert:.....	42	Disposal .....	64
User Settings menu .....	42	Cleaning .....	64
User Settings menu items .....	43		
Setting Language .....	43		
Setting Date and time .....	44		
Renaming the phone .....	45		
Setting the display settings .....	46		
Setting the audio settings.....	47		
Registration .....	50		
Registering the conference phone to the base.....	50		
Deregistering the conference phone...	51		
Registering the wireless mics to the base 52			
Deregistering the wireless mics .....	53		
Register a C52-SP DECT Expansion Speakerphone .....	54		
Deregister a C52-SP DECT Expansion Speakerphone .....	55		

# Introduction

## About the C620 SIP Wireless Conference phone

---

The C620 SIP Wireless Conference phone is designed for use in office settings. It consists of a base station, conference phone, and two wireless mics, enabling participants in a meeting room to deliver clear conversation during a conference call.

# Introduction

## Parts checklist

Your C620 SIP Wireless Conference phone package contains the items shown below. Save your sales receipt and original packaging in the event warranty service is necessary.

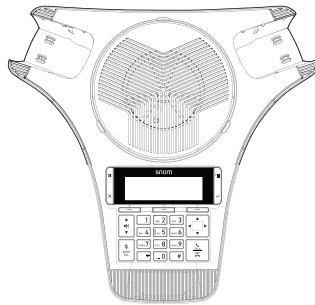
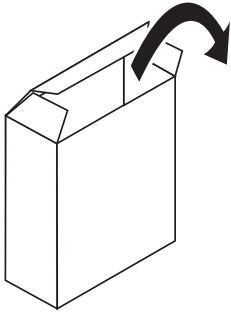

Conference Phone



Wireless Mic x2



Wireless Mic battery door x2



Wireless Mic battery x2

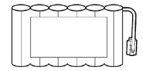

Conference Phone battery

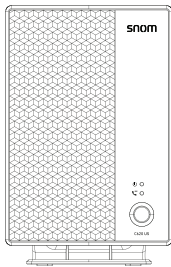

Base Station

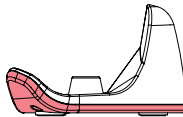

Charging Dock

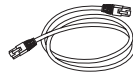

Ethernet cable



2 (two) screws for Conference Phone battery door



Screwdriver

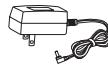

DC 12V 3A round jack power adapter for Charging Dock

**C620**

Quick  
Installation  
Guide

# Getting started

## Installing the base station

---

1. Plug one end of the Ethernet cable into the Ethernet port on the rear of the base station, and plug the other end of the cable into your network router or switch.
2. If the base station is not using power from a PoE-capable network router or switch, a power adapter, Manufacturer Mass Power, model no. NBS12E050200UV, Snom PN 00004570, is available separately.
  - Connect the power adapter to the base station power jack.
  - Plug the power adapter into an electrical outlet that is not controlled by a wall switch.

### IMPORTANT INFORMATION

- To order the power adapter, contact your vendor or Snom partner, or visit <https://service.snom.com/>.
- The power adapter is intended to be correctly oriented in a vertical or floor mount position. The prongs are not designed to hold the plug in place if it is plugged into a ceiling, under-the-table, or cabinet outlet.

## Installing the conference phone battery

---



- Risk of explosion! Batteries should not be exposed to excessive heat such as bright sunlight or fire.
  - Use only the supplied battery
1. After removing the battery door, plug the battery connector securely into the socket inside the battery compartment.
  2. Place the battery into the battery compartment with the label THIS SIDE UP facing up.
  3. Attach the battery door, and secure it in place with the provided screws.

## Connecting power to the conference phone

---

1. Plug the DC 12V 3A round jack end of the power adapter into the power jack on the back of the charging dock.
2. Plug the large end of the power adapter into a wall outlet not controlled by a switch.
3. Place the rear connectors of the conference phone into the charging dock.
  - The supplied DC 12V 3A round jack power adapter is designed for use only with the C620 conference phone. It is not designed to power other devices. Do not connect the supplied DC 12V 3A round jack power adapter to any other devices.

# Getting started

- The DC 12V 3A round jack power adapter is intended to be correctly oriented in a vertical or floor mount position. The prongs are not designed to hold the plug in place if it is plugged into a ceiling, under-the-table, or cabinet outlet.

## Installing the wireless mic battery

---

1. Plug the battery connector securely into the socket inside the battery compartment. Insert the battery (with the label THIS SIDE UP facing up) into the battery compartment.
2. Slide the battery door until it clicks into place.
3. Place the wireless mics into the charging cradles until they are flush.

NOTE: The status indicator on the wireless mic turns orange when charging, and turns off when the wireless mic is fully charged.

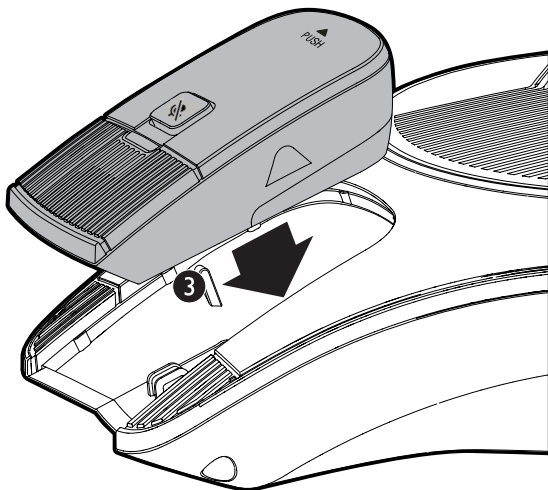
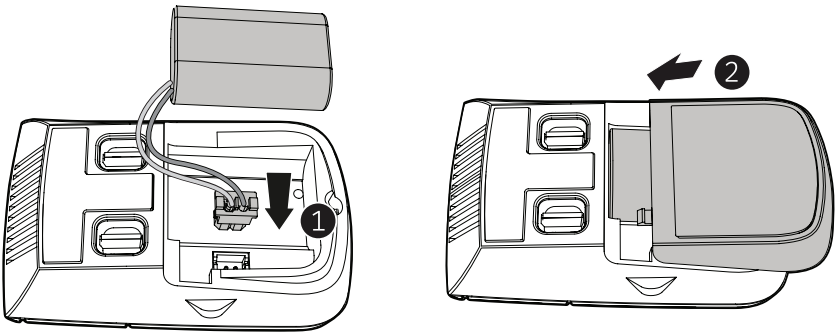



# Getting started

## Conference phone overview

---

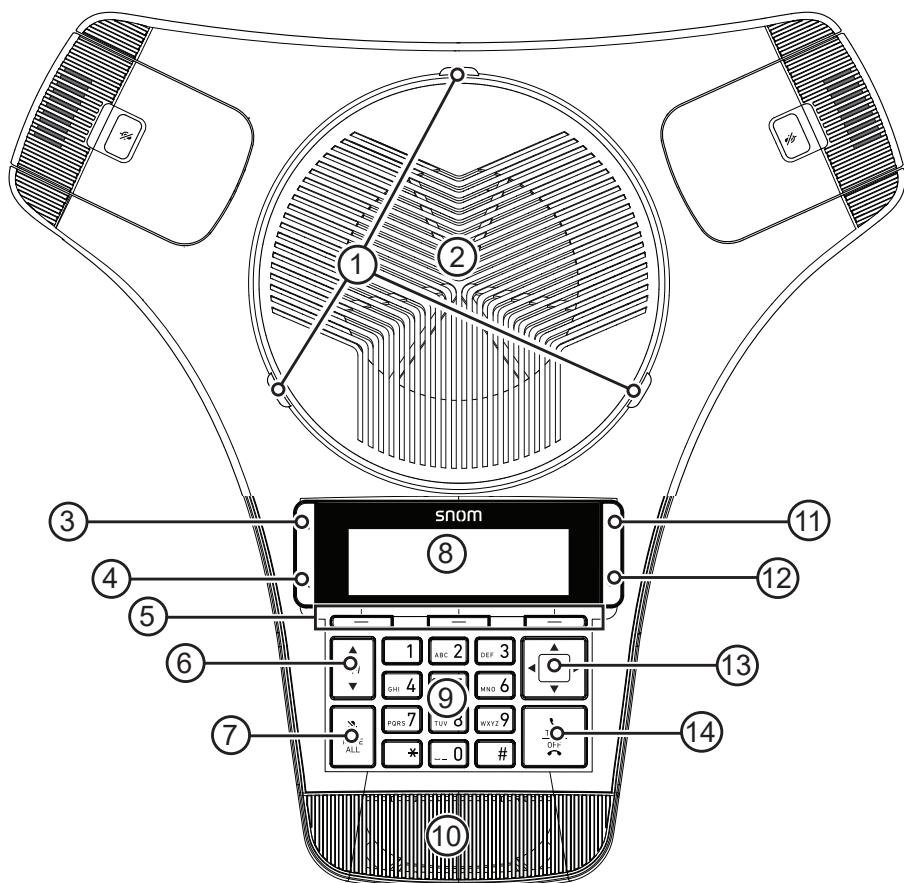

### 1. Status indicator

- Indicates the system status. See also "Status indicators on the conference phone / wireless mics" on page 9.

### 2. Speaker

### 3. (Hold)

- Press to put a call on hold. See "Putting a call on hold" on page 20.

### 4. (Cancel)

- Press to cancel an operation
- Press to exit the menu display
- Press to return to the idle screen.

# Getting started

## 5. Soft keys

- Press to perform actions as indicated by the on-screen labels.

## 6. VOL /

- When the phone is idle, press to adjust the ringer volume.
- During a call, press to adjust the listening volume.

## 7. MUTE ALL

- During a call, press to mute or end mute all microphones in the system.

## 8. LCD display screen

## 9. Dial pad keys

- Press to enter numbers or characters.
- See "Entering numerals, letters, and symbols" on page 14.

## 10. Front microphone

## 11. (Menu)

- Press to display the Main Menu.

## 12. (OK)

- Press to select a highlighted menu item
- Press to save an entry or setting in a menu.

## 13. Navigation keys p q / t u

- Press to scroll up or down while in the menu, directory, or call history.
- Press to move the cursor right or left while entering names or numbers.
- Press to view additional soft key labels.

## 14. TALK / OFF

- Press to make, answer, or end a call.

# Getting started

## Wireless mic overview

---

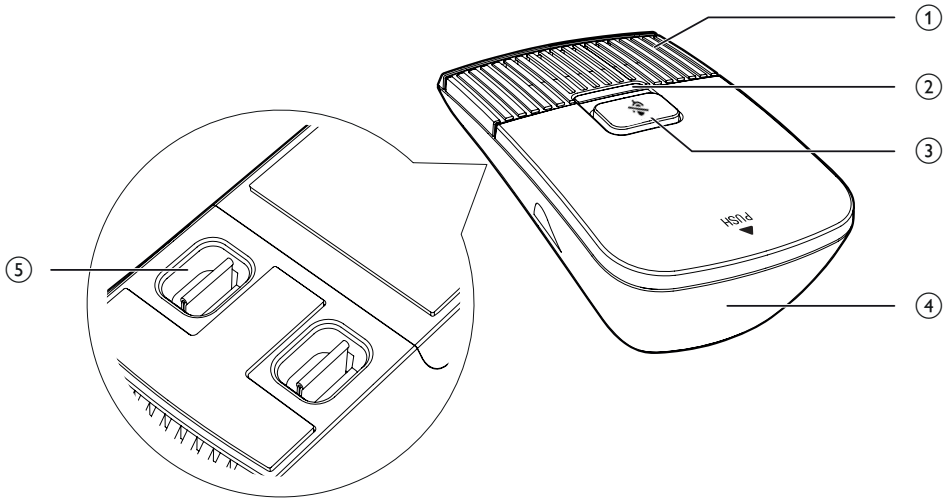

1. Microphone

- Functions as an extended microphone of the conference phone during a call.

2. Status indicator

- Indicates the system status. See "Status indicators on the conference phone / wireless mics" on page 9.

3.  (MUTE ALL)

- During a call, press to mute or end mute all microphones in the system.

4. Battery door



5. Charging contacts

# Getting started

## Base unit overview (front)

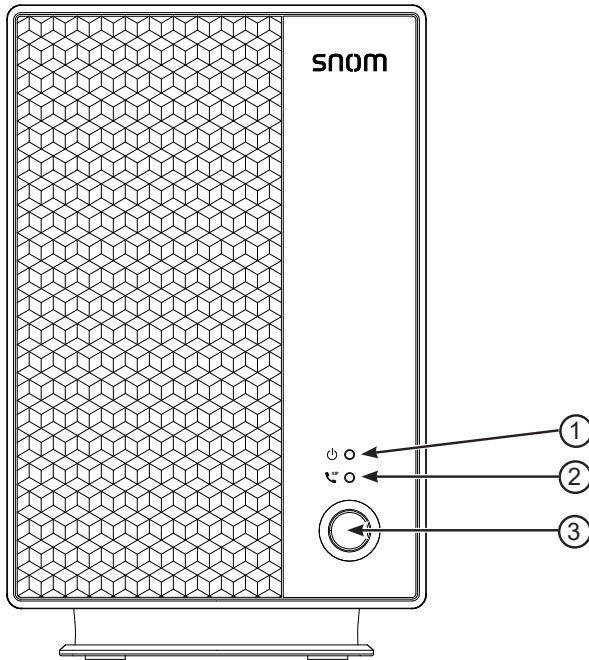
---



1.  (Power LED)
  - See "Status indicators on the base station" on page 11.
2.  (VoIP LED)
  - See "Status indicators on the base station" on page 11.
3. LINK key
  - Press to register the conference phone. See "Registration" on page 50.
  - Press to page the conference phone and wireless mics. See "Paging" on page 27.

# Getting started

## Status indicators on the conference phone / wireless mics

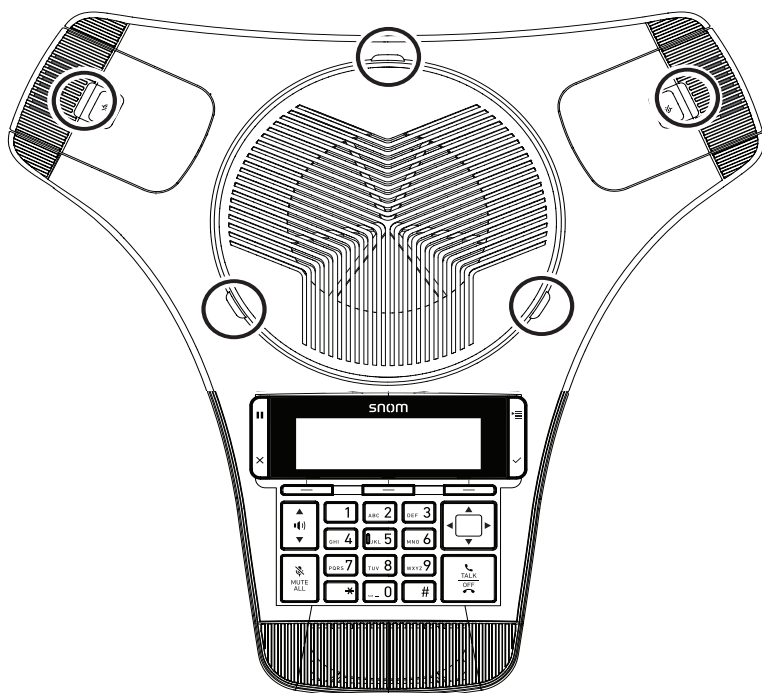

Function	Status indicator
Power up	<ul style="list-style-type: none"><li>Steady Orange for five seconds.</li></ul>
On a call	<ul style="list-style-type: none"><li>Steady Green during a call.</li><li>Steady Red when a call is muted, or if there are new messages.</li></ul>
Incoming call	<ul style="list-style-type: none"><li>Flashes Green quickly when there is an incoming call.</li></ul>
Charging	<ul style="list-style-type: none"><li>Steady Orange while charging</li><li>Steady Orange for five seconds when charging completed and you connect the conference phone to the charging dock.</li><li>Off when charging completed.</li></ul>
Low battery	<ul style="list-style-type: none"><li>Flashes Orange slowly</li></ul>
Stand by	<ul style="list-style-type: none"><li>Off when DECT linked; conference phone is idling; audio mode is not in use.</li></ul>

# Getting started

Function	Status indicator
Registration	<ul style="list-style-type: none"> <li>Flashes Red and Green alternately when DECT registration in progress.</li> <li>Steady Green for five seconds when registration successful.</li> <li>Steady Red for five seconds when registration failed or canceled.</li> </ul>
Paged by base station	<ul style="list-style-type: none"> <li>Flashes Green slowly</li> </ul>
DECT Searching Mode	<ul style="list-style-type: none"> <li>Flashes Red slowly when out of range or not registered.</li> </ul>
Reset mode	<ul style="list-style-type: none"> <li>Steady Orange</li> </ul>
CEC battery testing mode	<ul style="list-style-type: none"> <li>Flashes Red</li> </ul>

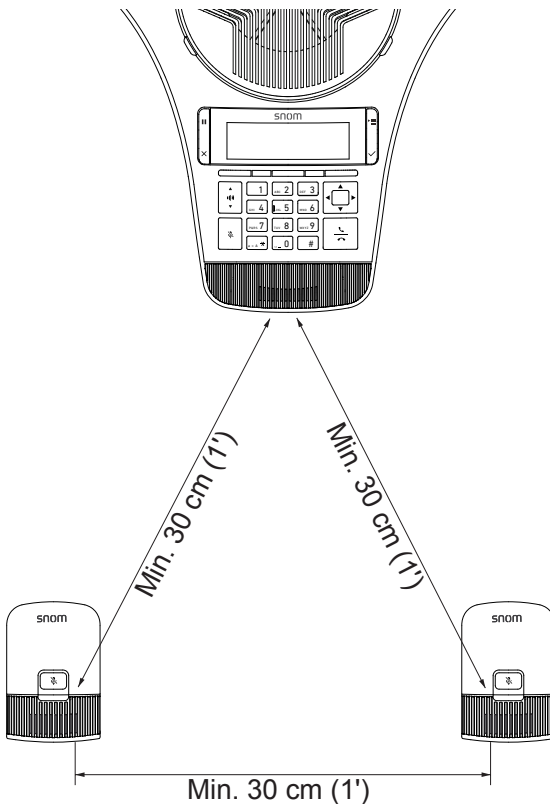

# Getting started

## Status indicators on the base station

---

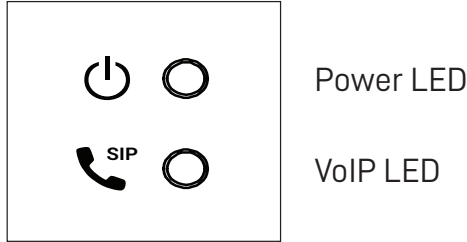

Power up	<ul style="list-style-type: none"><li>• Power LED is Steady Green.</li></ul>
Power down	<ul style="list-style-type: none"><li>• Power LED is Off.</li></ul>
Deregistration	<ul style="list-style-type: none"><li>• Power and VoIP LEDs flash Green quickly while ready to deregister devices.</li><li>• Power and VoIP LEDs are Steady Green for five seconds after the deregistration confirmation has elapsed.</li><li>• VoIP LED is Off when at least one SIP account is deregistered.</li></ul>
Registration	<ul style="list-style-type: none"><li>• Power and VoIP LEDs alternately flash Green slowly when base negotiating or checking with provisioning server.</li><li>• Power and VoIP LEDs flash Green slowly during device registration.</li><li>• VoIP LED is Steady Green when no SIP account is unregistered.</li></ul>
Firmware Upgrade	<ul style="list-style-type: none"><li>• Power and VoIP LEDs alternately flash Green quickly when firmware upgrade or configuration import in progress.</li></ul>

# Getting started

## Idle screen

The Idle screen appears after the phone is connected and configured for your SIP PBX service. The Idle screen indicates that you have no active or held calls.



From the Idle screen, you can press:

- **Dir** to view the directories that are available to you. See "Directory" on page 28.
- **Line** to select another line (account). When you make a call, the phone will use the selected line/account.
- **Call Log** to view the phone's call history. See "Call History" on page 33.

Note that the default Idle screen soft keys are shown above. Your phone's soft keys are programmable and may differ from what is listed here.

## Idle mode screen icons

In idle mode, the following screen icons indicate your phone's current settings.

Icon	Status
	Signal strength (1 to 4 bars).
	Ringer is OFF, or temporarily off during a call.
	Do not disturb is ON.
	Call Forward Always is ON.
	Battery level of conference phone (1 to 3 bars, blink for battery empty).

## Active call screen icons

During a call, the following screen icons indicate the call's status.

Icon	Status
	The conference phone is active.
	Microphone is muted on the conference phone and wireless microphones.







# Getting started

Icon	Status
1/2	Call counter - more than one call is active.
	More than one call is active. Press ▲ or ▼ to view another call.

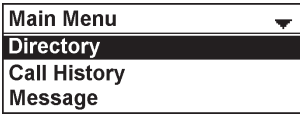
## Using the Main Menu

1. Press  to show the Main Menu.



2. Press ▼ or ▲ to highlight menu items.
3. Press  to select a highlighted menu item.
4. Press  or an appropriate soft key to save changes.
5. Press  to cancel an operation, exit the menu display or return to the idle screen.

## Main menu items

- Directory (see page 28)
- Call History (see page 33)
- Message (see page 25)
- Call Features (see page 38)
- Status & Settings (see page 42)

# Getting started

## Input Modes

---

When you dial a phone number, the input mode is always numerals.

When you edit directory entries, the current input mode is indicated by the label of the middle softkey. For example, **ABC** for uppercase letters.

To switch to the next input mode, press the middle softkey underneath the display.



- ABC** = Uppercase letters
- 123** = Numerals
- abc** = Lowercase letters

## Entering numerals, letters, and symbols

---

When entering letters and special characters, pause briefly after each character until the cursor has moved forward so that you won't overwrite the last character you entered. Pausing is not necessary when entering numerals.

### Numerals:

- When entering numerals, press the respective number key to type the number printed on the key.

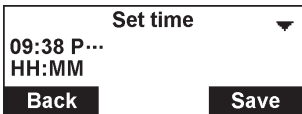

### Letters and Symbols:

- To switch between entering uppercase and lowercase letters, press the middle softkey until its label displays **ABC** or **abc**.
- When entering letters, press the alphanumeric key (**2-9**) with the respective letter one, two, three, or four times quickly to type the first, second, third, or fourth letter printed on the key. Pause briefly after each letter.

Example: When entering lowercase letters, press the "2" key once to type an "a", twice to type a "b", and three times to type a "c".

- When entering special characters and symbols, press the alphanumeric key (**0-9, \*, #**) as many times as needed. Pause briefly after each character or symbol. To see a list of symbols and which key to press, refer to the tables on the next page.

# Getting started

Input mode **ABC** :

	1x	2x	3x	4x	5x	6x	7x	8x	9x	10x	11x
1	~	^	`	%	!	&	-	_	+	=	
2	A	B	C	Æ	À	Á	Â	Ç	Œ		
3	D	E	F	È	É	Ê	Ë				
4	G	H	I	Í	Î	Ï					
5	J	K	L								
6	M	N	O	Ó	Ô	Ñ					
7	P	Q	R	S							
8	T	U	V	Ù	Ú	Û	Ü				
9	W	X	Y	Z	ÿ						
0	space	:	;	,	?						
✕	.	@	✕								
#	(	)	[	]	{	}	<	>	/	\	#

## Examples:

- Press the **1** key six times quickly to type the **&** character.
- Press the **2** key eight times quickly to type the **Ç** character.
- Press the **0** key once to type the space character.
- Press the **✕** key three times quickly to type the **✕** character.

Input mode **abc** :

	1x	2x	3x	4x	5x	6x	7x	8x	9x	10x	11x
1	~	^	`	%	!	&	-	_	+	=	
2	a	b	c	æ	à	á	â	ç	œ		
3	d	e	f	è	é	ê	ë				
4	g	h	i	í	î	ï					
5	j	k	l								
6	m	n	o	ó	ô	ñ					
7	p	q	r	s							
8	t	u	v	ù	ú	û	ü				
9	w	x	y	z	ÿ						
0	space	:	;	,	?						
✕	.	@	✕								
#	(	)	[	]	{	}	<	>	/	\	#

# Conference phone operation

## Making calls

---



You can make a call at any time by pressing  and then entering the number on the keypad. When the phone is in idle mode or has calls on hold, you can make a call

by entering the phone number on the keypad and then pressing  or **Dial** to call the number.

### Making a call:



1. Press  on the conference phone.

You will hear a dial tone.

2. Enter the phone number on the keypad.



- Press **Backspc** to delete an incorrect digit.

3. Press **Dial** or, if the number is valid, the phone dials the number after a short delay.



When the call is answered, the active call screen appears. The screen displays the elapsed time as you talk (in hours, minutes, and seconds).



Note that the default active call screen soft keys are shown above. Your phone's soft keys are programmable and may differ from what is shown here.

# Conference phone operation

## Making a call in idle mode or with call(s) on hold:

1. Enter the phone number on the keypad.

2125550178

**Backspc**

- Press **Backspc** to delete an incorrect digit.



2. Dial the number by pressing

When the call is answered, the active call screen appears.



Note that the default active call screen soft keys are shown above. Your phone's soft keys are programmable and may differ from what is shown here.

## Using a wireless microphone during a call

---

1. Take the wireless microphone from the phone's charging cradle and place it on the table near the intended person(s).
2. Speak towards the microphone.
  - For best performance, the person speaking should be at a distance of no more than 3 feet (91 cm).
  - Always return the wireless microphones to the charging cradles after use.

## Ending the call

---



- To end the call, press **End**.

## Answering a call

---



On the phone, press **Answer**.



On the incoming call screen, you can also press **Reject** to terminate the incoming call.

# Conference phone operation

## Call waiting

---

If you are on a call, and receive an incoming call from an outside number, the handset displays the Call Waiting screen. If you answer the call, your active call will be put on hold.



To answer the incoming call:

- Press **Reject** to terminate the incoming call.
- Press **Answer** to put the current call on hold and take the new call.
- Press ▼ or ▲ at any time to switch back and forth between calls. The call indicator (1/2, 2/2) shows which call is currently displayed.



## Missed calls

---

If you don't respond to an incoming call, the phone displays a missed-call alert screen.





If a missed call alert screen appears, you can press:

- **Exit** to return to the Idle screen.
- **Callback** to immediately dial the caller's number. If there is more than one missed call, your phone dials the number of the most recently missed call.
- **View** to display the Call History screen. Press twice to see the caller's information.

# Conference phone operation

## Redialing a call

---

1. When the phone is idle, press .
2. Press **▼** or **▲** to highlight **Call History**, then press .
3. Press **▼** or **▲** to highlight **Dialed Calls**, then press .

The Dialed Calls screen appears.

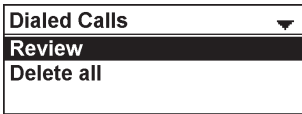

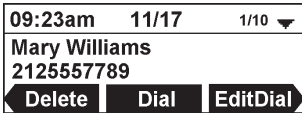

4. With **Review** selected, press .
5. Press **▼** and **▲** to select the number you want to redial.



6. Press **Dial** or .

## Adjusting call volume

---

During a call, press  **▲** or  **▼** to adjust the listening volume (1-9).

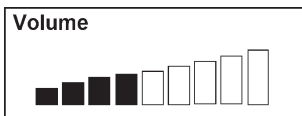



NOTE: When the volume reaches the minimum or maximum setting, you hear a beep.

## Muting active calls

---



The mute function enables you to hear the other party, but the other party cannot hear you.

### To mute all microphones:

- During a call, press **MUTE ALL** on the conference phone or press  on a wireless mic. The status indicators turn red, and the  symbol appears.

# Conference phone operation

## To end mute of all microphones:

- Press **MUTE ALL** on the conference phone or press  on a wireless mic.  
The status indicators turn green, and the  symbol disappears.

## Temporarily silencing the ringer

---

When the conference phone is ringing, you can temporarily silence the ringer without disconnecting the call. The next call rings normally at the preset volume.

### To silence the ringer:

- Press **MUTE ALL** on the conference phone.  
The  symbol appears.

NOTE: The conference phone rings when there is an incoming call unless the ringer volume of the conference phone is turned off.

## Putting a call on hold





---

Use this feature to hold one call while you access another. The phone also puts calls on hold automatically when you answer another call by pressing the **Answer** key, transfer a call, or create a conference.

During a call, press . The On hold screen appears.



From the **On hold** screen, you can press:

-  and  to select a call (if you have a call on hold and another call active or on hold).
-  and  to see the different softkeys available.
- **End** to end the call.
- **New** to dial a new call.  
See "Making a call in idle mode or with call(s) on hold:" on page 17
- **Resume** to take the call off hold.
- **Transfer** to transfer the held call to another party.  
See "Transferring calls" on page 21.
- **Conf.** to start a conference with the held call.  
See "To create a conference with a held call:" on page 24

Note that the default On hold screen soft keys are shown above. Your phone's soft keys are programmable and may differ from what is shown here.



# Conference phone operation

If another party puts you on hold, you may see the message **Held by far end**.

This message depends on compatibility between phones and PBX types, and may not always appear. Press **End** to end the call.



## Transferring calls

---

You can transfer a call to someone else at another phone.

If you talk to the transfer recipient before completing the transfer, you are making an **Attended transfer** (also called a **Supervised transfer**).

However, the transfer recipient does not have to talk to you before receiving the transferred call. If you do not talk to the transfer recipient before transferring the call, you are making a **Blind transfer**.

You can also transfer a call to a held call.

### To transfer a call (Attended transfer):

1. During a call, press **Transfer**.  
The Transfer to menu appears.

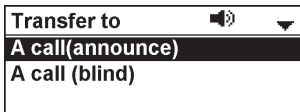

2. With **A call(announce)** highlighted, press .
3. Enter the number to which you want to transfer the call, and either press **Dial** or wait for the phone to dial automatically.
4. When the second call is established, you can talk to the party to notify them of the transfer, then press **Transfer** to transfer the call.





The **Call transferred** screen appears, and your phone returns to idle mode.



# Conference phone operation



## To cancel the transfer:

- Press  on the Transfer To screen. The active call screen reappears.  
-OR-  
Press  on the dialing screen. The On hold screen reappears.
- Press **End** when the second call is active. You will hang up on the second call.

## To transfer a call (Blind transfer):

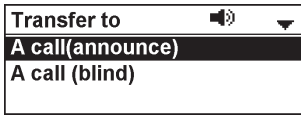
1. During a call, press **Transfer**.  
The Transfer to menu appears.



2. Press  or  to highlight **A call (blind)**, then press .
3. Dial the number to which you want to transfer the call, and press **Dial**.

The **Call transferred** screen appears, and your phone returns to idle mode.

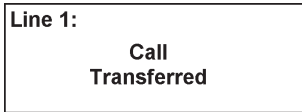

## To transfer a call to a held call:

1. During a call, press **Transfer**.  
The call is automatically put on hold, and the Transfer to screen appears, showing the held call.

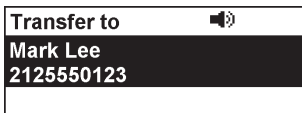

2. Press  to transfer the call to the held call.  
The Call transferred screen appears, and your phone returns to idle mode.

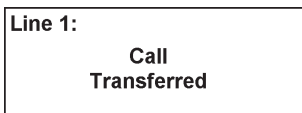

# Conference phone operation

## Making a conference call

---

You can hold a conference call between yourself and two other callers.

### To make a conference call using manual entry:

1. During a call, press **Conf.**.  
The call is automatically put on hold and the Conference with screen appears.

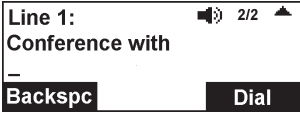

2. Enter the number for the party you want to join your conference, and press **Dial** or wait until phone dials automatically.
3. When the second call is established, you can talk to the party to advise them of the conference call.
4. Press **Conf.**.  
The conference begins and the conference screen appears.

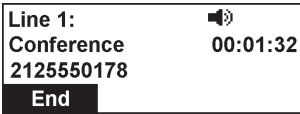

### To make a conference call using the directory or call history:

1. During a call, press **Conf.**.  
The call is automatically put on hold and the Conference with screen appears.



2. Press .
3. Press or to highlight **Directory** or **Call history**, and press .

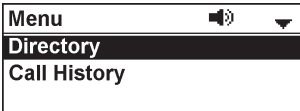

4. Press or to highlight the directory or call history you want to access, and press .

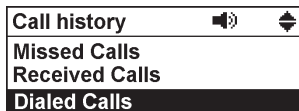

# Conference phone operation

5. For call history, press ▼ or ▲ to highlight **Review**, and press .

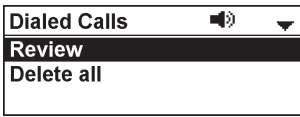

6. Press ▼ or ▲ to select the party you want to join your conference.

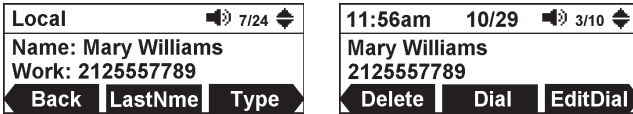

7. Press **Dial** or .

Your phone calls the number.

8. When the second call is established, you can talk to the party to advise them of the conference call.
9. Press **Conf.**

The conference begins and the conference screen appears.

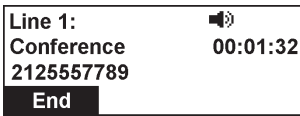

## To cancel the conference:

- Before dialing the second call: Press  on the Conference with screen. Press **Resume** to resume the held call.
- With the second call on the line: Press **End**. Press **Resume** to resume the held call.

## To create a conference with a held call:

When you have an active call and a held call, you can also create a conference with the held call.

1. During a call, press **Conf.**
- The Conference with screen appears, showing the held call.

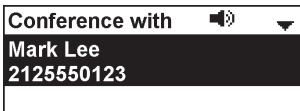

2. Press .

The conference begins and the conference screen appears.

# Conference phone operation



## Ending a conference call:

- Press **End** to hang up on both calls.

## Setting up a network conference

---

A network conference is hosted by your service provider and allows multiple parties to join a conference. A Network Conference works in a similar way to the regular conference described above.

In addition, the soft keys **Add** and/or **AddCall** will appear during a conference, allowing you to add more parties to the ongoing conference call.

## Retrieving messages

---

The conference phone displays the New Message(s) alert screen when you have a new voicemail message.



On the New Message(s) alert screen, you can press:

- **Exit** to return to the idle screen.
- **View** to access your messages. The Message Menu appears.

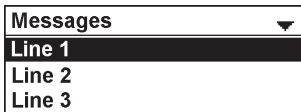



The message menu displays the mailboxes you can access from your phone. If your phone has more than one line, you may be able to access multiple mailboxes.

Press ▲ or ▼ to highlight the desired mailbox, and press  to access messages in that mailbox.

When there is no New Message(s) alert screen, you can access the Message menu using the phone menu.

# Conference phone operation

## To view the Messages menu:

1. When the phone is idle, press 
2. Press ▼ or ▲ to highlight **Message**, then press .

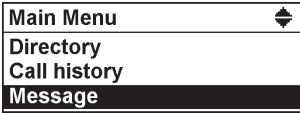

The Message menu appears.

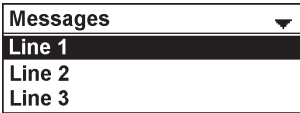

3. Press ▼ or ▲ to highlight a line, then press .
- Your conference phone dials the voicemail retrieval number.

# Conference phone operation

## Paging

---

This feature helps you find the conference phone and any misplaced wireless mics within the range of the base unit.

### To start the paging tone:

- Press the LINK key on the base station.

The Paging screen appears.



- The conference phone rings and the status indicators flash green.
- If the wireless mic is not in its cradle, the wireless mic beeps and the status indicator flashes red.

### To mute the paging tone:

- Press **Silence** on the conference phone.

-OR-

Press  (MUTE ALL) on the wireless mic or conference phone.

-OR-

Place the wireless mic in its cradle.

### To stop the paging tone:

- Press the LINK key on the base station.

-OR-

Press **Stop** on the conference phone.

Note: The paging tone automatically stops after 60 seconds has elapsed.

# Directory

## About the directory

---

The Directory menu enables you to store names and phone numbers in four types of directories:

- **Local** – available only on your conference phone.
- **Base** – available on all conference phones in your system.
- **Blacklist** – contains blocked numbers, and is available on all conference phones in your system.
- **Broadsoft directory** – enables access to your Broadsoft directories - Group, Group Common, Enterprise, Enterprise Common, or Personal.

Once directory entries are saved, you can dial them directly from the directory. You can also search directory entries by first or last name.

When adding an entry, you can enter numbers for work, mobile, and other. You can also select a ringtone and default line for that contact. Later, you can edit entries if their contact information changes.

## Viewing a directory

---

1. Press .

The Main Menu appears

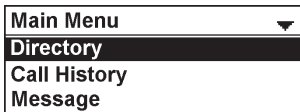

2. With **Directory** highlighted, press .

The Directory menu appears, listing all your available directories. Any directories other than Local are server-based and will vary with your installation. You can edit the Local directory, Base directory, and the Blacklist.

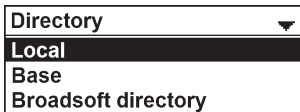

3. Press ▲ or ▼ to select the directory you wish to view, and then press .

The selected directory appears, showing the first entry (sorted alphabetically by first name).



4. Press ▲ or ▼ to view other entries.





# Directory

The following soft keys are available when viewing a directory entry. Press ◀ or ▶ to view the desired softkeys.

Back	Returns to Directory list screen	LastName	Sorts the list by last name / first name from the top of the list	Type	Displays the contact's other numbers: Work, Mobile, Other
		FirstName			
Dial	Dials the entry	Edit	Enables you to change the entry	Search	Enables you to search the list alphabetically by first or last name
Add	Enables you to add a new entry	Delete	Deletes the entry	Del. all	Deletes all entries

## Adding a directory entry

1. Press .
2. With **Directory** highlighted, press .
3. Press ▲ or ▼ to select the directory you want, and then press .
4. If the message "... directory is empty. Add new entry?" appears, press **Yes**. Otherwise, press ◀ or ▶ until the **Add** softkey appears, and then press **Add**.

The Add new screen appears.

**Add new** 1/25 ▼

**First Name:**  
\_







**Backspc** | **ABC** | **Next**

5. Use the keypad to enter the First name, Last name, Work, Mobile, and Other numbers. Press **Next** after entering each item.
  - To move the cursor left or right, press ◀ or ▶.
  - To erase a character/digit, press **Backspc**.
  - To move to the next item, press ▼ or **Next**.
  - To move back to the previous item, press ▲.
6. Press ◀ or ▶ to select a Ringer tone, and then press **Next**.
7. Press ◀ or ▶ to select a line.
8. To save the directory entry, press **Save**.

# Directory

## Reviewing directory entries







---

1. Press .
2. With **Directory** highlighted, press .
3. Press  or  to select the directory you want, and then press .
4. Press  or  to browse through the directory entries.

NOTE: When the directory is empty, the conference phone displays "... directory is empty. Add new entry?"

## Searching for a directory entry

---

1. Press .
2. With **Directory** highlighted, press .
3. Press  or  to select the directory you want, and then press .
4. Press  or  until the **Search** softkey appears.
5. Press **Search**.

The keyword search screen appears.



6. Use the dial pad keys to enter the first few characters of the name to be searched.
7. Press **Next**.

## Dialing a directory entry

---

1. Search for the desired entry in the directory (see "Reviewing directory entries" on page 30 or "Searching for a directory entry" on page 30).
2. To view other numbers for the entry, press **Type**.



3. When the desired number appears, press  or **Dial**.

Note: If you view a directory entry when the phone is in dial mode, press **Dial** to dial the number. You can use this feature when making a call and setting up a conference call.

# Directory

## Editing a directory entry

---

1. Search for the desired entry in the directory (see "Reviewing directory entries" on page 30 or "Searching for a directory entry" on page 30).
2. Press ◀ or ▶ until the **Edit** softkey appears.
3. Press **Edit**.

The Edit screen appears.



Edit ▼		
First Name: Mary		
Backspc	ABC	Next

4. Press ▲ or ▼ to select an item to edit.
5. Use the keypad to change the First name, Last name, Work, Mobile, and Other numbers. Press **Next** after entering each item.
  - To move the cursor left or right, press ◀ or ▶.
  - To erase a character/digit, press **Backspc**.
  - To move to the next item, press ▼ or **Next**.
  - To move back to the previous item, press ▲.
6. Press ◀ or ▶ to change the Ringer tone, and then press **Next**.
7. Press ◀ or ▶ to change the line.
8. To save your changes, press **Save**.

## Deleting a directory entry

---

1. Search for the desired entry in the directory (see "Reviewing directory entries" on page 30 or "Searching for a directory entry" on page 30).
2. Press ◀ or ▶ to until the **Delete** softkey appears.
3. Press **Delete**.

A confirmation screen appears.

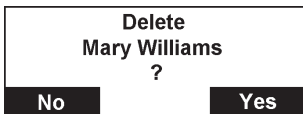

Delete	
Mary Williams	
?	
No	Yes

4. Press **Yes**.

# Directory

## Deleting all directory entries

---

1. From a directory entry, press ◀ or ▶ until the **Del. all** softkey appears.
2. Press **Del. all**.

A confirmation screen appears.



3. To confirm deletion, press **Yes**. To cancel deletion, press **No**.

# Call History

## Call history

---

The call history provides available name and number information for incoming and outgoing calls. The newest entries replace the oldest. You can view call history information for:

- Missed calls—incoming calls that were not answered.
- Received calls—incoming calls that you answered or silenced.  
Maximum 200 entries of combined Missed calls and Received calls.
- Dialed calls—all outgoing calls. You can use this as a redial list.  
Maximum 10 entries.





## Reviewing call history

---

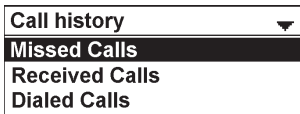
1. Press .
2. Press  or  to highlight **Call history**, then press .

The Call history screen appears.



3. Press  or  to highlight the desired call history folder, then press .
4. With **Review** highlighted, press .

The first entry appears.

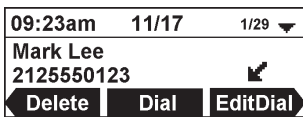

If the folder is empty, the message "No entries to display" appears.

5. Press  or  to view more entries.

The call history entry screen shows the time, date, name and number of the call, the number of entries in the folder, along with an icon indicating the type of call.



# Call History

The following soft keys are available when viewing a call history entry. Press ◀ or ▶ to view the desired softkeys.

<b>Delete</b>	Deletes the entry	<b>Dial</b>	Dials the entry	<b>Edit Dial</b>	Displays the predial screen so you can edit the number before dialing
<b>Save</b>	Saves the call information to the local directory				

## Dialing a call history entry

1. Search for the desired call history entry (see "Reviewing call history" on page 33).



2. While viewing the desired entry, press  or **Dial**.

The phone dials the number immediately.

-OR-

Press **Edit Dial**. The predial screen appears, allowing you to edit the number before pressing **Dial**.

- Press **Backspc** to delete a digit.

Note: If you view a call history entry when the phone is in dial mode, press **Dial** to dial the number. You can use this feature when making a call and setting up a conference call.

## Saving a call history entry to the directory

1. While viewing the desired entry, press ◀ or ▶ until the **Save** soft key appears.

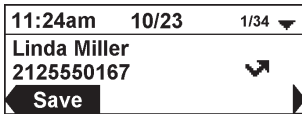

2. Press **Save**.
3. On the **Save to** menu, select the location to which you want to save the entry.



# Call History

The Add new screen appears. The phone automatically fills in the name and number, if available.

Add new ▾		
First Name:		
Linda		
Backspc	ABC	Next

- If necessary, edit the name and number.
  - To erase a character/digit, press **Backspc**.
  - To move to the next item, press ▾ or **Next**.
- Press ◀ or ▶ to change the line.
- To save the directory entry, press **Save**.





## Deleting a call history entry

---

- Search for the desired call history entry (see "Reviewing call history" on page 33).
- While viewing the desired entry, press **Delete**.



## Deleting all call history entries

---

- When the phone is idle, press .
- Press ▲ or ▼ to highlight **Call history**, then press .
- Press ▲ or ▼ to highlight the desired call history folder, then press .
- Press ▲ or ▼ to highlight **Delete all**, then press .

A confirmation screen appears.

<b>Delete all entries in Diald Calls ?</b>
--

- To confirm deletion, press . To cancel deletion, press .

# Speed dial

## Speed dial

---

The speed dial menu enables you to enter up to 10 numbers that you dial frequently.

### Dialing a speed dial number

---

- When the conference phone is not in use, press and hold a dialing key (**0-9**) that matches the speed dial entry number (for entry 10, press and hold **0**).

### Adding a speed dial entry

---

1. Press .

2. With **Directory** highlighted, press .

3. Press **▲** or **▼** to highlight **Speed Dial**, and then press .

The Speed Dial menu appears.

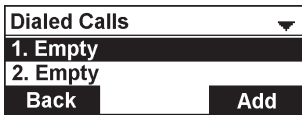

4. Press **▲** or **▼** to highlight a speed dial entry marked "Empty."

5. Press **Add**.

6. Use the keypad to change the Name and Number.

Press **Next** after entering each item.

- To move the cursor left or right, press **◀** or **▶**.
- To erase a character/digit, press **Backspc**.
- To move to the next item, press **▼** or **Next**.
- To move back to the previous item, press **▲**.

7. Press **◀** or **▶** to change the line, and then press **Next**.

8. To save the speed dial entry, press **Save**.

### Editing a speed dial entry

---

1. Press .

2. With **Directory** highlighted, press .

3. Press **▲** or **▼** to highlight **Speed Dial**, and then press .

4. Press **▲** or **▼** to highlight the speed dial entry you want to reassign.

5. Press **Edit**.





## Speed dial

- Use the dial pad keys to change the Name and Number.  
Press **Next** after entering each item.
  - To select a character/digit, press ◀ or ▶.
  - To erase a character/digit, press **Backspc**.
  - To move to the next item, press ▼ or **Next**.
  - To move back to the previous item, press ▲.
- Press ◀ or ▶ to change the line, and then press **Next**.
- To save your changes, press **Save**.

### Deleting a speed dial entry

---

- Press .
- With **Directory** highlighted, press .
- Press ▲ or ▼ to highlight **Speed Dial**, and then press .
- Press ▲ or ▼ to highlight the speed dial entry you want to delete.
- Press **Delete**.

A confirmation screen appears.

Delete Mary Williams ?	
No	Yes

- Press **Yes**.

# Settings





You can change the conference phone settings from the Call Features menu (see below) and the User Settings menu (see page 42).

The following pages describe how to change the conference phone settings from both menus.

## Call Features Menu





---

### To display the Call Features menu:

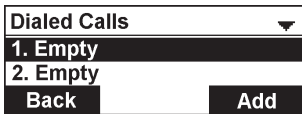
1. Press  when the conference phone is not in use.
2. Press  or  to highlight **Call Features**, and then press .

The Call Features menu appears.



3. Press  or  to highlight menu items.
4. Press  to select a highlighted menu item.
5. Press  to save changes.
6. Press  to cancel an operation or return to the previous menu.

### Call Features menu items

---

- Do Not Disturb (see page 39)
- Call Forwarding (see page 39)
- Block Anonymous (see page 41)
- Dial as Anonymous (see page 41)
- Missed Call Alert (see page 42)
- Call Waiting Alert (see page 42)

# Settings

## Setting Do Not Disturb (DND)

---

You can set Do Not Disturb (DND) for each line assigned to your phone. When DND is set, the ringer is silenced and the phone rejects incoming calls and pages; the caller receives the busy signal. After rejecting a call, the phone displays the Missed Calls screen.

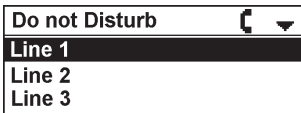

### To turn DND on or off:

1. From the Call Features menu, press ▲ or ▼ to highlight **DND**, and then press .  
The Do not Disturb menu appears.

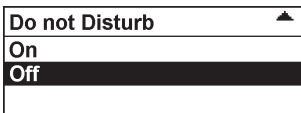

2. Press ▲ or ▼ to highlight the desired line, and then press .
3. Press ▼ or ▲ to highlight **On** or **Off**.



4. Press  to save your selection. You will hear a confirmation tone.  
When DND is on,  appears on the idle screen.

## Setting Call Forwarding

---

Call forwarding automatically forwards incoming calls depending on the setting. You can enable the following types of call forwarding:

- **Always:** incoming calls are forwarded immediately and the phone does not ring.
- **Busy:** incoming calls are forwarded if all your available lines are busy.
- **No answer:** incoming calls are forwarded after the no answer delay expires.

### To set call forward:

1. From the Call Features menu, press ▲ or ▼ to highlight **Call forwarding**, and then press .  
The Call forward menu appears.

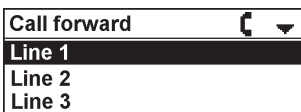

# Settings

2. Press ▲ or ▼ to highlight the line for which you want to configure call forward settings, and then press .
3. Press ▼ or ▲ to highlight the desired option:
  - Always
  - Busy
  - No answer

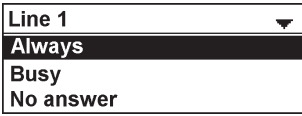

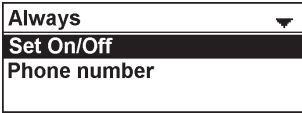

4. Press .
5. On the next screen, with **Set On/Off** highlighted, press .

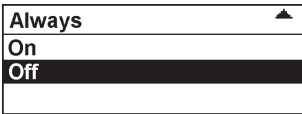

6. Press ▼ or ▲ to highlight **On** or **Off**, and then press .



7. Press ▼ or ▲ to highlight **Phone number**, and then press .
8. Enter the phone number to which you would like to forward calls.
  - To erase a digit, press **Backspc**.
9. To save your call forward settings, press **Save**.  
You will hear a confirmation tone.
10. If you selected No answer earlier, press ▼ or ▲ to highlight **No ans. delay**, and then press .
11. Press ▼ or ▲ to highlight the No Answer delay between 1 and 10 rings, and then press .

When Call forward Always is on,  appears on the idle screen.

# Settings

## Setting Block Anonymous

---

Block Anonymous enables the phone to reject incoming calls that have no caller ID.

### To set block anonymous:

1. From the Call Features menu, press ▲ or ▼ to highlight **Block anonymous**, and then press .

The Block Anonymous menu appears.

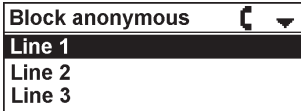

2. Press ▲ or ▼ to highlight the desired line, and then press .
3. Press ▼ or ▲ to highlight **On** or **Off**.

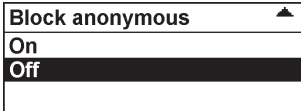

4. Press  to save your selection. You will hear a confirmation tone.

## Setting Dial as Anonymous

---

Dial as Anonymous enables the phone to make outgoing calls with the Caller ID hidden from the far end.

### To set dial as anonymous:

1. From the Call Features menu, press ▲ or ▼ to highlight **Dial as anonyms**, and then press .

The Dial as anonyms menu appears.

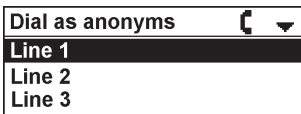

2. Press ▲ or ▼ to highlight the desired line, and then press .
3. Press ▼ or ▲ to highlight **On** or **Off**.

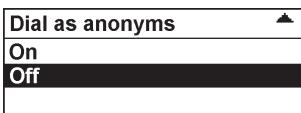

4. Press  to save your selection. You will hear a confirmation tone.

# Settings

## Setting Missed Call Alert

---

The Missed call alert setting enables the phone to display the missed call alert screen (see "Missed calls" on page 18).

### To set missed call alert:

1. From the Call Features menu, press ▲ or ▼ to highlight **Miss call alert**, and then press .
2. Press ▼ or ▲ to highlight **Show alert** or **Hide alert**.

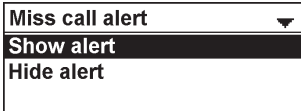

3. Press  to save your selection. You will hear a confirmation tone.

## Setting Call Waiting alert

---

The Call waiting setting enables or disables incoming call alerts while you are on another call.

### To set call waiting alert:

1. From the Call Features menu, press ▲ or ▼ to highlight **Call waiting**, and then press .
2. Press ▼ or ▲ to highlight **Show alert** or **Hide alert**.

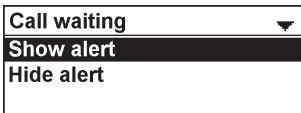

3. Press  to save your selection. You will hear a confirmation tone.

## User Settings menu

---

### To display the User Settings menu:

1. Press  when the conference phone is not in use.

The Main Menu appears

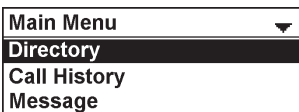

# Settings

2. Press ▼ or ▲ to highlight **Status & Settings**, and press .

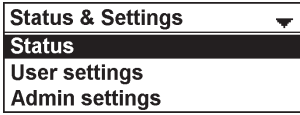

The Status & Settings menu appears.

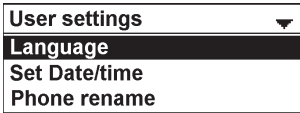

3. Press ▼ or ▲ to highlight **User settings**, and press .

The User settings menu appears.



4. Press ▼ or ▲ to highlight menu items.
5. Press  to select a highlighted menu item.
6. Press  to save changes.
7. Press  to cancel an operation or return to the previous menu.

## User Settings menu items

---

- Language (see page 43)
- Set Date/Time (see page 44)
- Phone rename (see page 45)
- Display (see page 46)
- Audio (see page 47)
- Registration (see page 50)

## Setting Language

---

You can select English, French, or Spanish to be used in the conference phone screen display.

### To set the language:

1. From the User settings menu, press ▲ or ▼ to highlight **Language**, and then press .

The Language menu appears.

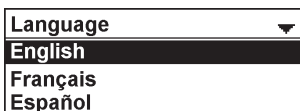

# Settings

2. Press ▲ or ▼ to select the desired language.
3. Press  to save your selection. You will hear a confirmation tone.

## Setting Date and time

---

Before using the C620, set the date and time as follows. The date and time will be displayed on the conference phone when idle.

### To set the date format:

1. From the User settings menu, press ▼ or ▲ to highlight **Set Date/Time**, and then press .

The Set Date/Time menu appears.

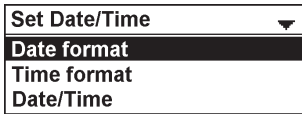

2. With **Date format** highlighted, press .

The Date format screen appears.

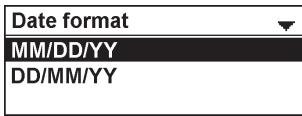

3. Press ▼ or ▲ to select the desired date format (MM/DD/YY or DD/MM/YY).
4. Press  to save your selection. You will hear a confirmation tone.

### To set the time format:

1. From the User settings menu, press ▼ or ▲ to highlight **Set Date/Time**, and then press .

2. Press ▼ or ▲ to highlight **Time format**, and then press .

The Time format screen appears.

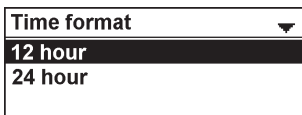



3. Press ▼ or ▲ to select the desired time format (12 hour or 24 hour).
4. Press  to save your selection. You will hear a confirmation tone.



# Settings

## To manually set the date and time:

1. From the User settings menu, press ▼ or ▲ to highlight **Set Date/Time**, and then press .
2. Press ▼ or ▲ to highlight **Date/Time**, and then press .
3. On the Set date screen, enter the date.





Set date 

11/24/19  
MM/DD/YY

Back Next

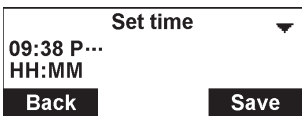
- The currently selected month/day/year is flashing.
  - Use the dialing keys to enter a two-digit number, or press ▲ or ▼ to select a number.  
The conference phone beeps twice if you enter an invalid number.
  - To move to the next number, press **Next**.
  - To move to the previous number, press **Back**.
4. On the Set time screen, enter the time.



Set time 

09:38 P...  
HH:MM

Back Save

- The currently selected hour/minute is flashing.
  - Use the dialing keys to enter a two-digit number, or press ▲ or ▼ to select a number.  
The conference phone beeps twice if you enter an invalid number.
  - To move to the next number, press **Next**.
  - To move to the previous number, press **Back**.
  - For 12-hour time format, press ▲ or ▼ to select ... (AM) or P... (PM).
5. Press **Save** to save your selection. You will hear a confirmation tone.

## Renaming the phone

---

You can rename the conference phone from the default "SPEAKER BOX".

### To rename the conference phone:

1. From the User settings menu, press ▼ to highlight **Phone rename**, and then press .
- The Phone rename screen appears.

# Settings



2. Use the dialing pad to enter the new name.
  - To delete a character, press **Backspc**.
3. Press **Save** to save your selection. You will hear a confirmation tone.

## Setting the display settings

---

Use the display menu to set the screen appearance and backlight behavior.

### To set the contrast:

1. From the User settings menu, press ▼ or ▲ to highlight **Display**, and then press .

The Display menu appears.



2. With **Contrast** highlighted, press .

The Contrast screen appears.



3. Press ▼ or ▲ to select the desired contrast level (1 to 7).
4. Press  to save your selection. You will hear a confirmation tone.

### To set backlight:

1. From the User settings menu, press ▼ or ▲ to highlight **Display**, and then press .

2. press ▼ or ▲ to highlight **Backlight On**, **BackLight Idle**, or **Timeout\***, and then press .

- If you selected **Backlight On** or **BackLight Idle**, press ▼ or ▲ to select **On** or **Off**.
- If you selected **Timeout**, press ▼ or ▲ to choose the timeout period between 10 and 60 seconds.

# Settings

Being triggered ▼ On Off	During idle ▲ On Off	Backlight Time ▼ 10 seconds 15 seconds 20 seconds
--------------------------------	----------------------------	--

3. Press  to save your selection. You will hear a confirmation tone.

## \* NOTES:

- If **Backlight On** is off and **BackLight Idle** is on, the LCD backlight always lights up.
- If **Backlight On** is on and **BackLight Idle** is off, the LCD backlight turns off after being idle for as long as the set **Timeout** period.
- If **Backlight On** and **BackLight Idle** are both off, the LCD backlight is always off.

## Setting the audio settings

---

Use the audio menu to set the ringer tone and advisory tones for low battery, link lost, key press, hold reminder tone, and on cradle tone.

### To set the ringer tone:

1. From the User settings menu, press ▼ or ▲ to highlight **Audio**, and then press .

The Audio menu appears.

Audio ▼
Ringer Tone
Advisory Tones

2. With **Ringer Tone** highlighted, press .

The Ringer Tone screen appears.

Ringer Tone  ▼
Line 1
Line 2
Line 3

3. Press ▲ or ▼ to highlight the desired line, and then press .

4. Press ▼ or ▲ to sample each ringer tone (Melody 1 to Melody 10).

Line 1 
Melody 5
Melody 6
Melody 7

5. Press  to save your selection. You will hear a confirmation tone.

# Settings

## To set the ringer volume:



When the phone is idle, press  or  to change the ringer volume level as desired.

## To set the low battery tone:

1. From the User settings menu, press  or  to highlight **Audio**, and then press .

2. press  or  to highlight **Advisory Tones**, and then press .

The Advisory Tones screen appears.

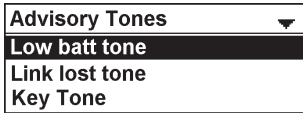

3. With **Low batt tone** highlighted, press .

4. Press  or  to select **On** or **Off**.

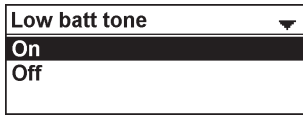

5. Press  to save your selection. You will hear a confirmation tone.

## To set the link lost tone:

1. From the User settings menu, press  or  to highlight **Audio**, and then press .

2. Press  or  to highlight **Advisory Tones**, and then press .

3. Press  or  to highlight **Link lost tone**, and then press .

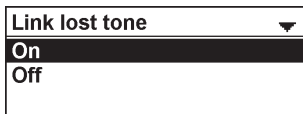

4. Press  or  to select **On** or **Off**.





5. Press  to save your selection. You will hear a confirmation tone.

# Settings

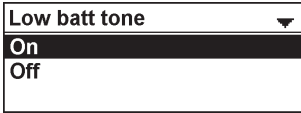

## To set the key tone:

1. From the User settings menu, press ▼ or ▲ to highlight **Audio**, and then press .
2. Press ▼ or ▲ to highlight **Advisory Tones**, and then press .
3. Press ▼ or ▲ to highlight **Key Tone**, and then press .
4. Press ▼ or ▲ to select **On** or **Off**.



5. Press  to save your selection. You will hear a confirmation tone.

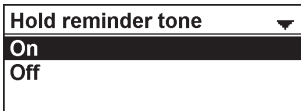

## To set the hold reminder tone:

1. From the User settings menu, press ▼ or ▲ to highlight **Audio**, and then press .
2. Press ▼ or ▲ to highlight **Advisory Tones**, and then press .
3. Press ▼ or ▲ to highlight **Hold reminder tone**, and then press .
4. Press ▼ or ▲ to select **On** or **Off**.



5. Press  to save your selection. You will hear a confirmation tone.

## To set the on cradle tone:

1. From the User settings menu, press ▼ or ▲ to highlight **Audio**, and then press .
2. Press ▼ or ▲ to highlight **Advisory Tones**, and then press .
3. Press ▼ or ▲ to highlight **On cradle tone**, and then press .
4. Press ▼ or ▲ to select **On** or **Off**.

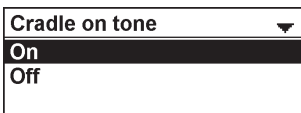

5. Press  to save your selection. You will hear a confirmation tone.

# Registration

## Registering the conference phone to the base

Your conference phone is pre-registered to the base station. If you need to manually re-register the conference phone, follow these steps:

1. Place the conference phone in the charging dock, and make sure it is connected to power.

2. If the conference phone is displaying



go to step 6.

3. If the conference phone is displaying

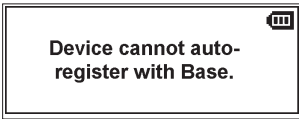

go to step 7.

4. If the conference phone is displaying

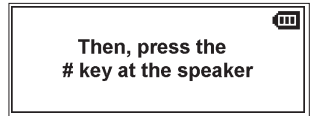
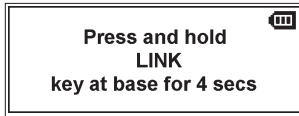
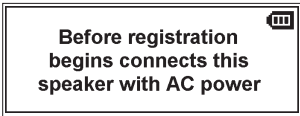

go to step 8.

5. If the conference phone is displaying



go to step 7.

6. Press **Cancel**.

The conference phone displays the following messages:

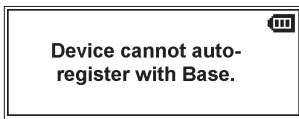

7. Press **Yes**.

The conference phone displays the following message:

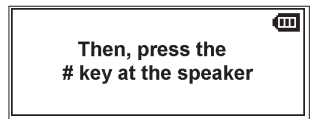
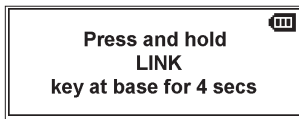
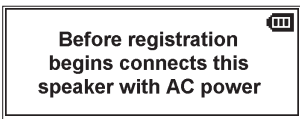





8. On the base station, press and hold the LINK key for 4 seconds. Both LEDs on the base station begin to flash.

# Registration

9. Press the # key on the conference phone to begin registration.  
The conference phone displays the message "Registering... please wait."  
When registration is complete, the conference phone beeps and then displays "Speaker Registered."  
If the conference phone fails to register, remove it from the charger for a few seconds, replace it in the charger, and repeat the registration procedure.

## Deregistering the conference phone

---

1. Press .
2. Press ▼ or ▲ to highlight **Status & Settings**, and then press .
3. Press ▼ or ▲ to highlight **User Settings**, and then press .
4. Press ▼ or ▲ to highlight **Registration**, and then press .
5. Press ▼ or ▲ to highlight **Deregistration**, and then press .

<b>Registration</b> ▲
<b>This Speaker</b>
<b>Wireless Microphone</b>
<b>Deregistration</b>

6. Press ▼ or ▲ to highlight the <device name> of the conference phone.  
For example, "SPEAKERBOX 1".

<b>Deregistration</b> ▼
<b>SPEAKER BOX</b> 1
<b>MICROPHONE</b> 2
<b>MICROPHONE</b> 3

7. Enter the PIN. Default PIN is 1590.

If deregistration is successful, the conference phone displays a message.  
For example, "SPEAKER BOX 1 Handset is deregistered."





# Registration

## Registering the wireless mics to the base

---

Your wireless mics are pre-registered to the base station.

If you need to manually re-register the wireless mics, follow these steps:

1. Press .
2. Press ▼ or ▲ to highlight **Status & Settings**, and then press .
3. Press ▼ or ▲ to highlight **User Settings**, and then press .
4. Press ▼ or ▲ to highlight **Registration**, and then press .
5. Press ▼ or ▲ to highlight **Wireless microphone**, and then press .

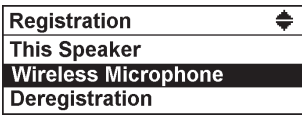

6. Press ▼ or ▲ to highlight **with Base station**, and then press .

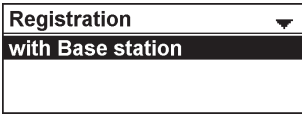





7. Follow the instructions on the conference phone screen.  
Press **NEXT** to move through the screens.
  - a. Connect the conference phone with AC power (by placing it in the charging dock).
  - b. Put one wireless mic on the conference phone charge cradle
  - c. Press and hold the LINK key on the base station for 4 seconds.
  - d. Press and hold the  key on the wireless mic for 3 seconds.  
If registration is successful, the mic LED lights up in green for 5 seconds  
If registration is unsuccessful, the mic LED lights up in red for 5 seconds.
8. To register the second wireless mic, repeat step 6 to 7.



# Registration

## Deregistering the wireless mics

---

1. Press .
2. Press **▼** or **▲** to highlight **Status & Settings**, and then press .
3. Press **▼** or **▲** to highlight **User Settings**, and then press .
4. Press **▼** or **▲** to highlight **Registration**, and then press .
5. Press **▼** or **▲** to highlight **Deregistration**, and then press .

<b>Registration</b>	
<b>This Speaker</b>	
<b>Wireless Microphone</b>	
<b>Deregistration</b>	

6. Press **▼** or **▲** to highlight the wireless microphone you want to deregister.

<b>Deregistration</b>	
<b>SPEAKER BOX</b>	<b>1</b>
<b>MICROPHONE</b>	<b>2</b>
<b>MICROPHONE</b>	<b>3</b>

7. Enter the PIN. Default PIN is 1590.  
If deregistration is successful, the conference phone displays a message.  
For example, "MICROPHONE 3 Handset is deregistered."
8. To deregister another wireless mic, go to step 5.

# Registration

## Register a C52-SP DECT Expansion Speakerphone

---

You can register up to two C52-SP DECT Expansion Speakerphones to your C620 SIP Wireless Conference Phone.

### If your organization uses DECT auto registration:

The C52-SP will automatically register to the C620. You do not need to take any further action.

### If your organization does NOT use DECT auto registration (or if you are not sure):

You must first turn off auto registration on the C52-SP by performing the following steps:

1. Press and hold the **MUTE ALL** button on the C52-SP for five seconds.
2. Press and hold the **TALK/OFF** button on the C52-SP for five seconds.

The C52-SP LEDs turn steady orange for five seconds, then slowly flash orange.



At this point, you can manually register the C52-SP to the C620 by following the instructions below.

### Manually register the C52-SP to the C620

1. Press and hold the REGISTRATION button on the bottom of the C52-SP unit for five seconds.

When you release the button, the C52-SP LEDs will flash red and green alternately. This indicates the C52-SP is ready for registration.

2. Press and hold the LINK key on the C620 base unit for four seconds.

The  and  LEDs flash green for about 10 seconds, then turn steady green.

If registration is successful, the LEDs on the C52-SP turn green for five seconds.







If registration fails, the LEDs on the C52-SP turn red for five seconds.

3. To register an additional C52-SP speakerphone, follow the instructions in "Register a C52-SP DECT Expansion Speakerphone", above.

# Registration

## Deregister a C52-SP DECT Expansion Speakerphone

---

1. Press .
2. Press ▼ or ▲ to highlight **Status & Settings**, and then press .
3. Press ▼ or ▲ to highlight **User Settings**, and then press .
4. Press ▼ or ▲ to highlight **Registration**, and then press .
5. Press ▼ or ▲ to highlight **Deregistration**, and then press .
6. On the Deregistration menu, press ▼ to select **WIRELESS SPE**, and then press .
7. Enter the PIN. Default PIN Is 1590.  
The conference phone displays the message "WIRELESS SPE X is deregistered."

# Conference phone battery

## Charging

---

It takes up to 11 hours for the conference phone battery to be fully charged (the battery icon has 3 bars ). When the conference phone is fully charged, you can expect the following operating times:

Operation	Operating time
While the conference phone is in use (talking)	Up to 5 hours
The conference phone is not charging and not in use (standby)	Up to 7 days

### The battery needs charging when:

- A new battery is installed into the conference phone.
- The battery icon has no bars and is flashing .

### CAUTION:

#### To reduce the risk of fire or injury, read and follow these instructions:

- Use only the batteries provided or equivalent. To order a replacement, visit our website at [snomamericas.com](http://snomamericas.com).
- Do not dispose of the batteries in a fire. Check with local waste management codes for special disposal instructions.
- Do not open or mutilate the batteries. Released electrolyte is corrosive and may cause burns or injury to the eyes or skin. The electrolyte may be toxic if swallowed.
- Exercise care in handling batteries in order not to create a short circuit with conductive materials.
- Charge the batteries provided with or identified for use with this product only in accordance with the instructions and limitations specified in this manual.
- Observe proper polarity orientation between the battery and metallic contacts.
- To prevent fire or shock hazard, do not expose this product to water or any type of moisture.

## Battery disposal

---

Disposal of electrical and electronic products and of batteries should be done in line with local regulations. Please contact local authorities for further information.

# Factory reset

## Factory reset the base station

---

1. Using a paperclip, or something similar, press and hold the reset button on the back of the base station for 15 seconds.
2. Release the reset button. During the next one to two minutes, the following occurs:
  - The conference phone displays "Please wait".
  - The VoIP LED on the base station flashes quickly, then the Power LED and the VoIP LED flash alternately.
  - The conference phone beeps once and displays "Out of range or no power at base".
  - The status indicators on the conference phone flash red quickly.
  - The conference phone displays the idle screen. This indicates the factory reset has completed.

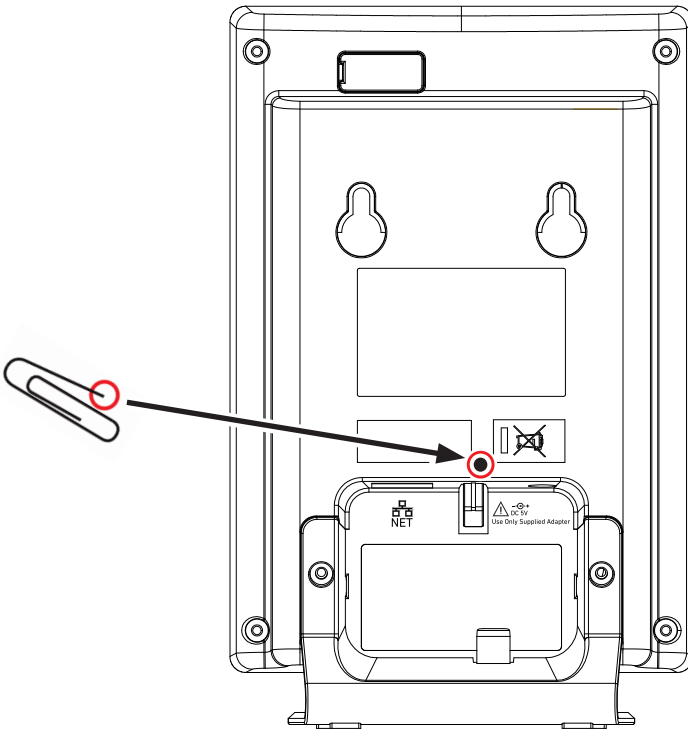

# Troubleshooting

If you have difficulty with your conference phone, please try the suggestions below. For customer service, visit our Service Hub at <https://service.snom.com/>.

## My C620 SIP Wireless Conference phone does not work at all.

After powering up the base station (see page 3), the LCD display will show



the idle screen. Press  and you will hear a dial tone. If any of this does not happen, please try the following:

- Make sure the PoE cable or the power adapter is securely connected to the base station, and, if using the power adapter, plugged into a wall outlet not controlled by a wall switch.
- Make sure the DC 12V 3A round jack power adapter is securely connected to the conference phone charging dock, and plugged into a wall outlet not controlled by a wall switch.

## I cannot dial out.

- Try all the above suggestions.
- Make sure there is a dial tone before dialing.
- If other telephones in your office are having the same problem, the problem is in the wiring or telephone service. Contact your IP PBX system administrator.
- Eliminate any background noise. Dial from another room in your office with less background noise.

## The conference phone does not ring when there is an incoming call.

- Make sure there is a dial tone before dialing.
- Make sure the ringer volume of the conference phone is not set to off (page 48).
- Make sure the PoE cable, or the ethernet cable and the base station DC 5V 2A power adapter, and the charging dock DC 12V 3A power adapter are plugged in properly (see page 3).
- If other telephones in your office are having the same problem, the problem is in the wiring or IP PBX service. Contact your service provider (charges may apply) or system administrator.
- Other electronic products such as ham radios and other DECT phones can cause interference with your conference phone. Try installing your conference phone as far away as possible from these types of electronic devices.
- Unplug the base station from its power source (PoE cable or power adapter). Wait for approximately 15 seconds, and then plug it back in. If you still cannot get a dial tone, please contact our customer service website designated above for assistance.

# Troubleshooting

## My wireless mic does not work at all.

The status indicator on the wireless mic turns green within 2 seconds when a call has been established on the conference phone.

If the status indicator remains off and inactive, please follow the steps below:

1. Remove the wireless mic from the charging cradle.
2. Remove the battery from the wireless mic, then install the battery again (page 4).
3. Return the wireless mic to the charging cradle. Make sure the wireless mic is placed in the charging cradle correctly.

The status indicator under the  button should turn orange.

If the status indicator remains off at the time the wireless mic returned to the charging cradle, the wireless mic or the charging cradle is probably defective. Please contact customer service for assistance.

If the status indicator does not turn orange, please follow the steps below:

1. Remove the wireless mic from the charging cradle.
2. Remove the battery from the wireless mic, then install the battery again (page 4).
3. Return the wireless mic to the charging cradle. Make sure the wireless mic is placed in the charging cradle correctly.

The status indicator under the  button should turn orange.  
The wireless mic is charging now.

4. Allow the wireless mic to be charged for at least 30 minutes.
5. Remove the wireless mic from the charging cradle again.
6. Establish a call on the phone. The status indicator under the  button should turn green within 2 seconds.

If that still does not work, the wireless mic might have lost its connection to the base station.

1. Deregister all the wireless mics from the base station (see page 53).
2. Register all the wireless mics to the base station (see page 52).
3. Establish a call on the phone. The status indicator under the  button should turn green.

If that still does not work, you might have a defective battery or a defective wireless mic. Please contact customer service for assistance.

**Note:** Every time the base station is powered up, the wireless mics will need some time to connect to the base station. Please allow at least one minute for the wireless mic and base station to synchronize before use after the base station has powered up.

**Note:** If you have more than one C620 SIP Wireless Conference phone in the office, use the **Paging** function (page 27) to identify the wireless mics that are

# Troubleshooting

connected to the corresponding base station. Make sure that they are not mixed up between each of your C620 SIP Wireless Conference phone.

## **The callers cannot hear me when I am using the wireless mic.**

Try one of the following:

- Make sure the wireless mic is not muted during a call.
- Move the wireless mic closer to the conference phone. It may be out of range.
- Speak into the wireless mic from a distance of no more than 3 feet (91 cm).
- Reset the base station. Unplug the base station from its power source (PoE cable or power adapter). Wait for approximately 15 seconds, and then plug it back in. Allow at least one minute for the wireless mics and base station to synchronize.
- If you have more than one C620 SIP Wireless Conference phone in the office, use the **Paging** function (page 27) to identify the wireless mics that are connected to the corresponding base station. Make sure that they are not mixed up between each of your C620 SIP Wireless Conference phones.
- Other electronic products such as ham radios and other DECT phones can cause interference with your C620 SIP Wireless Conference phone. Try installing your C620 SIP Wireless Conference phone as far away as possible from these types of electronic devices.

## **Status Indicator on the wireless mic flashes orange.**

The wireless mic has low battery.

- Place the wireless mic onto the charging cradle for recharging.

For optimal battery life performances:

- Charge the wireless mics for up to 8 hours before the first time of use.
- Return the wireless mics to the charging cradle after use. Charge them for at least 30 minutes before subsequent uses.

## **Status Indicator on the wireless mic flashes orange even after a long period of charging.**

The efficiency of the battery might have been reduced after being used for some time.

- Make sure the wireless mic is placed in the charging cradle correctly when charging.
- Remove and install the battery again and use it until the battery is fully depleted, and then charge the wireless mic in charging cradle for 8 hours.
- If the above measures do not solve the problem, replace the battery.



# Troubleshooting

## The status indicator on the wireless mic does not turn orange when in charging cradle.





- The wireless mic might be fully charged.
- Clean the charging contacts on the wireless mic and the charging cradles each month with a pencil eraser or a dry non-abrasive fabric.
- Make sure the base station PoE cable (or the ethernet cable and the DC 5V 2A power adapter), telephone line, and the charging dock DC 12V 3A round jack power adapter are plugged in properly (see page 3).
- Make sure the wireless mic is placed in the charging cradle correctly.
- Unplug the base station PoE cable or the power adapter. Wait for 15 seconds before plugging it back in. Allow up to one minute for the wireless mic and base station to reset.
- Lift the wireless mic and place it back into the charging cradle. If the wireless mic status indicator turns orange for 5 seconds, and then turns off, the battery is fully charged.

## There is interference during a telephone conversation.

### My calls fade out when I am using the wireless mic.

- Move the wireless mic closer to the conference phone. It may be out of range.
- Appliances plugged into the same circuit as the base station can cause interference. Try moving the appliance or base station to another outlet.
- Other electronic products such as ham radios and other DECT phones can cause interference with your conference phone. Try installing your conference phone as far away as possible from these types of electronic devices.

## I have accidentally set my conference phone language to Spanish or French, and I don't know how to change it back to English.

1. Press  when the conference phone is not in use or on a call.
2. Press ▼ or ▲ to highlight **Estado y configuración** or **Statuts et réglages**, and then press .
3. Press ▼ or ▲ to highlight **Ajustes usuario** or **Régl. utilisat.**, and then press .
4. Press ▼ or ▲ to highlight **Idioma** or **Langage**, and then press .
5. Press ▼ or ▲ to highlight **English**, and then press .

# Important information

Please read the instructions on safety and disposal and on how to set up and use the device before using it and also give them to other users to read or inform those users of their contents. Save this manual and do not give the device to third parties without it.

The name plate is located at the bottom or at the rear of the product.

## Safety instructions

Follow the instructions in this manual and other applicable documentation of the device.

- The product detailed in this document is to be connected only to PoE networks without routing to the outside plant.
- Mount the device only at heights not exceeding 2m.
- The socket outlet for pluggable equipment must be near the equipment and easily accessible.
- If the phone is not supplied with power via the Ethernet cable, use only the power adapter included in the delivery. Other power supplies may damage or destroy the phone, affect its behavior, or induce noise.
- Avoid placing the cables where people may trip over them or where they may be exposed to mechanical pressure as this may damage them.
- Recommended temperature range for operation: +5°C to +35°C, max. humidity 85%.
- This device is NOT FOR OUTDOOR USE! Indoor use only.
- Do not install the device in rooms with high humidity (for example, in bathrooms, laundry rooms, damp basements). Do not immerse the device in water and do not spill or pour liquids of any kind onto or into the device.
- Do not install the device in surroundings at risk for explosions (paint shops, for example). Do not use the device if you smell gas or other potentially explosive fumes.
- Lightning striking the power grid may cause electric shocks. Do not use the device during thunderstorms.
- Operation of any equipment emitting radio frequency signals may interfere with the functionality of inadequately shielded medical devices. Consult the manufacturer of the medical device to determine if they are adequately shielded from external radio frequency (RF) energy or if you have any other questions concerning this topic.
- If you have an implanted medical device (e.g., pacemaker), use only if the manufacturer's directions expressly permit the use of devices emitting pulsating radio frequency signals. Recommended MINIMUM distance to the device: 100 cm.

## Standards conformance

 This device complies with Directive 2014/53/EU, the Radio Equipment Regulations 2017 of the UK, and the essential health, safety, and environmental requirements of all relevant European, Australian, and UK directives.





The declaration of conformity can be downloaded at [www.snom.com/conformity](http://www.snom.com/conformity).

**SELV (Safety Extra Low Voltage) Compliance:** Safety status of input/output connections comply with SELV requirements.

Unauthorized opening, changing, or modifying the device will cause the warranty to lapse and may also result in the loss of conformity. In case of malfunction contact authorized service personnel, your seller, or Snom.

## Technical specifications

- **Safety:** IEC 62368-1
- **Connectors:**
  - **Base station:**
    - 1 x RJ45 (Ethernet) - LAN
    - 1 x coaxial power port
  - **Charging dock:** 1 x coaxial power port
- **Ethernet:** 10/100 MB
- **Batteries**



- **Phone:** CORUN, model no. Ni-MH 18670-4000 7.2V
- **Wireless mics:** CORUN, model no. Ni-MH 2/3AAA400mAh 2.4V
- **Power over Ethernet** (base station): IEEE 802.3af, Class 2. If PoE not available, a power adapter is available separately.

### • Power adapter



- **Base station:**
  - Manufacturer Mass Power, model no. NBS12E050200UV, Snom PN 00004570 (not included in delivery)
- **Charger:**
  - EU: Csec - model no. CS36M120300FGF
  - UK: Csec - model no. CS36M120300FBF
  - AU: Csec - model no. CS36M120300FAF
- **DECT:** 5 registers (2 wireless mics + 3 others)
- **Optimal distance** between base unit or wireless mic and participant: 60 cm
- **Minimum distance** between microphones: 30 cm

## Important battery information

Use only the batteries that came with the product or contact Snom if you need replacement batteries. **Caution:** do not use any other type of battery since this may lead to leakage, fire, explosion, or other dangerous situations. Never disassemble, alter, or short-circuit batteries or use them for purposes other than the intended one. Charge batteries only within the phone and the detachable wireless microphones.

### Charging and discharging, storage

- The full performance of a new batteries is achieved only after two or three complete charge and dis-charge cycles.

- The batteries can be charged and discharged hundreds of times, but they will eventually wear out. Contact Snom if you need to replace the batteries.
- If left unused, a fully charged battery will lose its charge over time.
- Use the batteries only for their intended purpose. Do not short-circuit the batteries. Short-circuiting the terminals may damage the batteries or the connecting object. Do not use a damaged charger or battery. Using a damaged battery may cause it to explode.
- Do not place or store the batteries, inside or outside the microphone, in the immediate vicinity of open fire or other heat sources.
- Leaving the batteries in hot or cold places will reduce their capacity and lifetime. Charge batteries within an ambient temperature range of +5° C to +40° C, max. humidity 85%. A device with a hot or cold battery may not work temporarily, even when the battery is fully charged.
- Avoid overcharging. Repeated overcharging can lead to deterioration in batteries performance. Never attempt charging the batteries with reversed polarity as this may cause the gas pressure inside the batteries to rise and lead to leakages.
- Remove batteries if storing product for more than 1 month.
- Store batteries in a cool, dry place without corrosive gases. Temperature range for storage of charged batteries up to 6 months: -20° C to +45° C ; up to 2 years: -20° C to +35° C; humidity 65±20%. Discharge and charge batteries every 3 months.

## Disposal of the device and batteries



This device is subject to European Directive 2012/19/EU and may not be disposed of with general household garbage.



The batteries provided with this product are subject to European Directive 2006/66/EC and may not be disposed of with general household garbage.



Never throw batteries into a fire! Do not mechanically crush or cut batteries, as that can result in an explosion.

If you do not know where to dispose of the device or the batteries at the end of their lifespan, contact your municipality, local waste management provider, or vendor

## For countries outside the European Union

Disposal of electrical and electronic products and batteries in countries outside the European Union should be done in line with local regulations. Please contact local authorities for further information.

## Cleaning

To clean the device, use an anti-static cloth. Please avoid cleaning liquids as they might damage the surface or internal electronics of the device.

Snom Technology GmbH  
Aroser Allee 66  
13407 Berlin, Deutschland  
office.de@snom.com

Snom Technology GmbH  
Via Milano 1  
20020 Lainate, Italia  
office.it@snom.com

Snom Technology GmbH  
The Courtyard, High Street  
Ascot, Berkshire SL5 7HP, UK  
office.uk@snom.com

Snom Technology GmbH  
130 avenue Joseph Kessel  
78960 Voisins-le-Bretonneux,  
France  
office.fr@snom.com

VTech Communications Inc.  
Snom Americas  
9020 SW Washington Square  
Road,  
Suite 555  
Tigard, OR 97223  
U.S.A.

VTech Technologies Canada Ltd.  
Suite 222  
12888 Wireless Way  
Richmond, B.C. V6V 0A3  
Canada

**Manufacturer:**

VTech Telecommunications Ltd.  
23/F., Tai Ping Industrial Centre,  
Block 1,  
57 Ting Kok Road, Tai Po  
HONG KONG