

snom



C620

SIP Wireless Conference Phone

User Manual

Copyright, Trademarks, Legal Disclaimers

© 2024 Snom Technology GmbH. All Rights Reserved.

Snom, the names of Snom products, and Snom logos are trademarks owned by Snom Technology GmbH.

All product specifications are subject to change without notification. Snom Technology GmbH. reserves the right to revise and change this document at any time, without being obliged to announce such revisions or changes beforehand or after the fact.

Although due care has been taken in the compilation and presentation of the information in this document, the data upon which it is based may have changed in the meantime. Snom therefore disclaims all warranties and liability for the accurateness, completeness, and currentness of the information published, except in the case of intention or gross negligence on the part of Snom or where liability arises due to binding legal provisions.

Important Information

Please read the instructions on safety and disposal and on how to set up and use the device before using it and also give them to other users to read or inform those users of their contents. Save this manual and do not give the device to third parties without it.

Table of contents

Introduction.....	1	Adjusting call volume.....	19
About the C620 SIP Wireless Conference phone.....	1	Muting active calls.....	19
Introduction.....	2	Temporarily silencing the ringer.....	20
Parts checklist.....	2	Putting a call on hold.....	20
Getting started	3	Transferring calls	21
Installing the base station	3	Making a conference call.....	23
Installing the conference phone battery.....	3	Setting up a network conference	25
Connecting power to the conference phone.....	3	Retrieving messages.....	25
Installing the wireless mic battery	4	Paging	27
Conference phone overview.....	5	Directory.....	28
Wireless mic overview	7	About the directory	28
Base unit overview (front).....	8	Viewing a directory.....	28
Status indicators on the conference phone / wireless mics	9	Adding a directory entry	29
Status indicators on the base station	11	Reviewing directory entries	30
Idle screen.....	12	Searching for a directory entry.....	30
Idle mode screen icons.....	12	Dialing a directory entry	30
Active call screen icons	12	Editing a directory entry	31
Using the Main Menu	13	Deleting a directory entry.....	31
Main menu items	13	Deleting all directory entries.....	32
Input Modes.....	14	Call History.....	33
Entering numerals, letters, and symbols.....	14	Call history	33
Conference phone operation.....	16	Reviewing call history	33
Making calls.....	16	Dialing a call history entry	34
Using a wireless microphone during a call	17	Saving a call history entry to the directory	34
Ending the call.....	17	Deleting a call history entry.....	35
Answering a call	17	Deleting all call history entries.....	35
Call waiting.....	18	Speed dial	36
Missed calls.....	18	Speed dial.....	36
Redialing a call	19	Dialing a speed dial number	36
		Adding a speed dial entry	36
		Editing a speed dial entry	36
		Deleting a speed dial entry.....	37

Table of contents

Settings	38	Appendix	57
Call Features Menu	38	Conference phone battery	57
Call Features menu items	38	Battery disposal	57
Setting Do Not Disturb (DND)	39	Factory reset the base station	58
Setting Call Forwarding	39	Troubleshooting	59
Setting Block Anonymous	41	Important safety instructions	63
Setting Dial as Anonymous	41	Important safety instructions	63
Setting Missed Call Alert	42	Battery	66
Setting Call Waiting alert	42	About wireless mics	66
To set call waiting alert	42	Maintenance	67
User Settings menu	42	FCC and IC regulations	68
User Settings menu items	43	FCC part 15	68
Setting Language	43	Industry Canada	69
Setting Date and time	44	The RBRC® seal	69
Renaming the phone	45	California Energy Commission (CEC) battery charging testing instructions	70
Setting the display settings	46	For cUL compliance only	71
Setting the audio settings	47	Mesures de sécurité importantes .	71
Registration	50	À propos des microphones sans fil	74
Registering the conference phone to the base	50	Technical specifications	75
Deregistering the conference phone	51		
Registering the wireless mics to the base 52			
Deregistering the wireless mics	53		
Register a C52-SP DECT Expansion Speakerphone	54		
Deregister a C52-SP DECT Expansion Speakerphone	55		
Password warning on idle screen	55		

Introduction

About the C620 SIP Wireless Conference phone

The C620 SIP Wireless Conference phone is designed for use in office settings. It consists of a base station, conference phone, and two wireless mics, enabling participants in a meeting room to deliver clear conversation during a conference call.

Introduction

Parts checklist

Your C620 SIP Wireless Conference phone package contains the items shown below. Save your sales receipt and original packaging in the event warranty service is necessary.

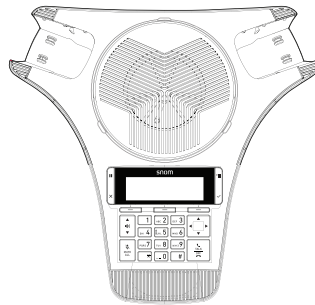
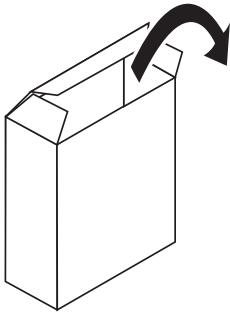

Conference Phone



Wireless Mic x2



Wireless Mic battery door x2



Wireless Mic battery x2

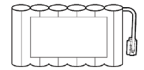

Conference Phone battery

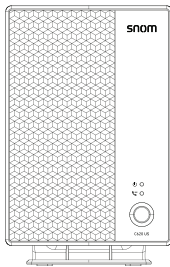

Base Station

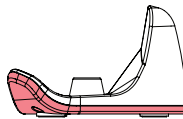

Charging Dock

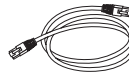

Ethernet cable



2 (two) screws for Conference Phone battery door



Screwdriver



DC 5V 800mA power adapter for Base Station

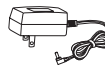

DC 12V 3A round jack power adapter for Charging Dock

C620

Quick
Installation
Guide

To purchase any accessories or replacements, visit our website at www.snomamericas.com.

Getting started

Installing the base station

1. Plug one end of the Ethernet cable into the Ethernet port on the rear of the base station, and plug the other end of the cable into your network router or switch.
2. If the base station is not using power from a PoE-capable network router or switch:
 - Connect the provided DC 5V 800mA power adapter to the base station power jack.
 - Plug the power adapter into an electrical outlet that is not controlled by a wall switch.

IMPORTANT INFORMATION

- Use only the DC 5V 800mA power adapter provided with the product. To order a replacement power adapter, visit our website at **www.snomamericas.com**.
- The power adapter is intended to be correctly oriented in a vertical or floor mount position. The prongs are not designed to hold the plug in place if it is plugged into a ceiling, under-the-table, or cabinet outlet.

Installing the conference phone battery



- Risk of explosion! Batteries should not be exposed to excessive heat such as bright sunlight or fire.
 - Use only the supplied battery
1. After removing the battery door, plug the battery connector securely into the socket inside the battery compartment.
 2. Place the battery into the battery compartment with the label **THIS SIDE UP** facing up.
 3. Attach the battery door, and secure it in place with the provided screws.

Connecting power to the conference phone

1. Plug the DC 12V 3A round jack end of the power adapter into the power jack on the back of the charging dock.
2. Plug the large end of the power adapter into a wall outlet not controlled by a switch.
3. Place the rear connectors of the conference phone into the charging dock.
 - The supplied DC 12V 3A round jack power adapter is designed for use only with the C620 conference phone. It is not designed to power other devices. Do not connect the supplied DC 12V 3A round jack power adapter to any other devices.

Getting started

- The DC 12V 3A round jack power adapter is intended to be correctly oriented in a vertical or floor mount position. The prongs are not designed to hold the plug in place if it is plugged into a ceiling, under-the-table, or cabinet outlet.

Installing the wireless mic battery

1. Plug the battery connector securely into the socket inside the battery compartment. Insert the battery (with the label **THIS SIDE UP** facing up) into the battery compartment.
2. Slide the battery door until it clicks into place.
3. Place the wireless mic into the charging cradles until they are flush.

NOTE: The status indicator on the wireless mic turns orange when charging, and turns off when the wireless mic is fully charged.

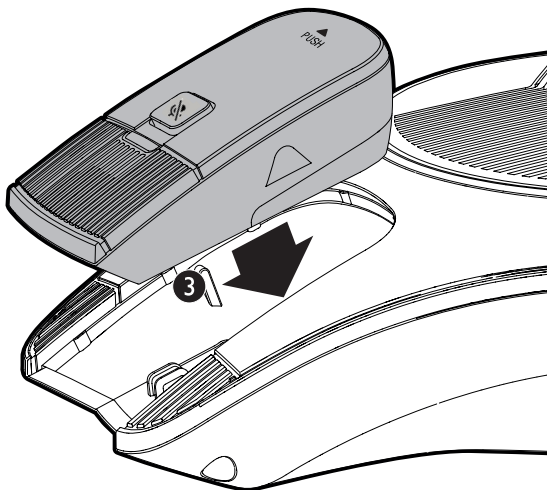
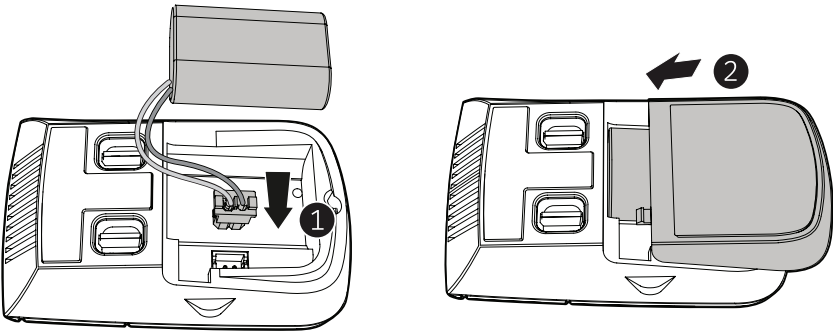

Getting started

Conference phone overview

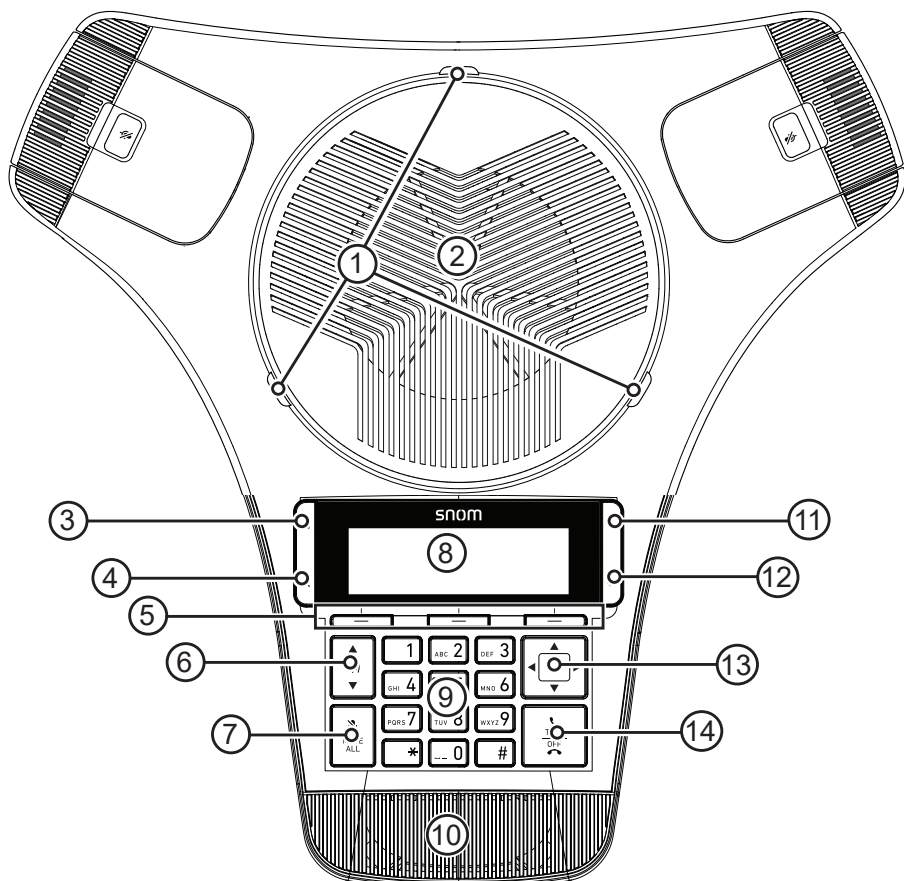

1. Status indicator

- Indicates the system status. See also "Status indicators on the conference phone / wireless mics" on page 9.

2. Speaker

3. (Hold)

- Press to put a call on hold. See "Putting a call on hold" on page 20.

4. (Cancel)

- Press to cancel an operation
- Press to exit the menu display
- Press to return to the idle screen.

Getting started

5. Soft keys

- Press to perform actions as indicated by the on-screen labels.

6. VOL /

- When the phone is idle, press to adjust the ringer volume.
- During a call, press to adjust the listening volume.

7. MUTE ALL

- During a call, press to mute or end mute all microphones in the system.

8. LCD display screen

9. Dial pad keys

- Press to enter numbers or characters.
- See "Entering numerals, letters, and symbols" on page 14.

10. Front microphone

11. (Menu)

- Press to display the Main Menu.

12. (OK)

- Press to select a highlighted menu item
- Press to save an entry or setting in a menu.

13. Navigation keys /

- Press to scroll up or down while in the menu, directory, or call history.
- Press to move the cursor right or left while entering names or numbers.
- Press to view additional soft key labels.

14 TALK / OFF

- Press to make, answer, or end a call.

Getting started

Wireless mic overview

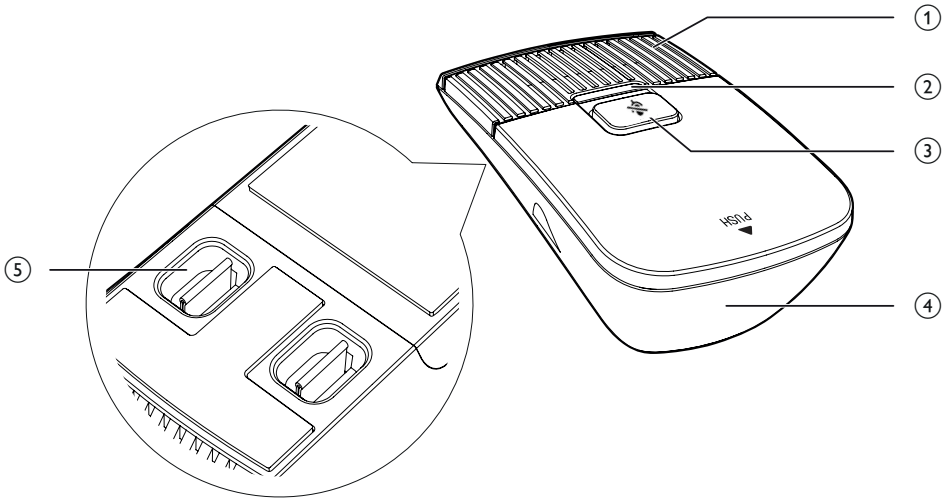

1. Microphone

- Functions as an extended microphone of the conference phone during a call.

2. Status indicator

- Indicates the system status. See "Status indicators on the conference phone / wireless mics" on page 9.

3. (MUTE ALL)

- During a call, press to mute or end mute all microphones in the system.

4. Battery door

5. Charging contacts

Getting started

Base unit overview (front)

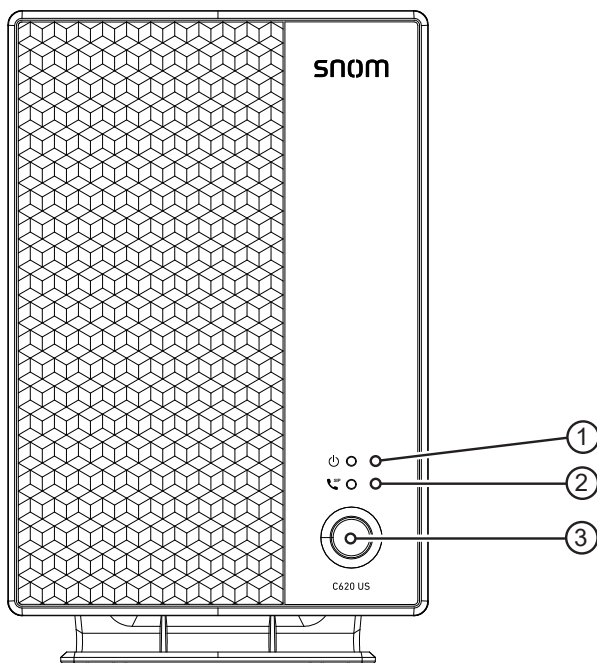

1. (Power LED)

- See "Status indicators on the base station" on page 11.

2. (VoIP LED)

- See "Status indicators on the base station" on page 11.

3. LINK key

- Press to register the conference phone. See "Registration" on page 50.
- Press to page the conference phone and wireless mics. See "Paging" on page 27.

Getting started

Status indicators on the conference phone / wireless mics

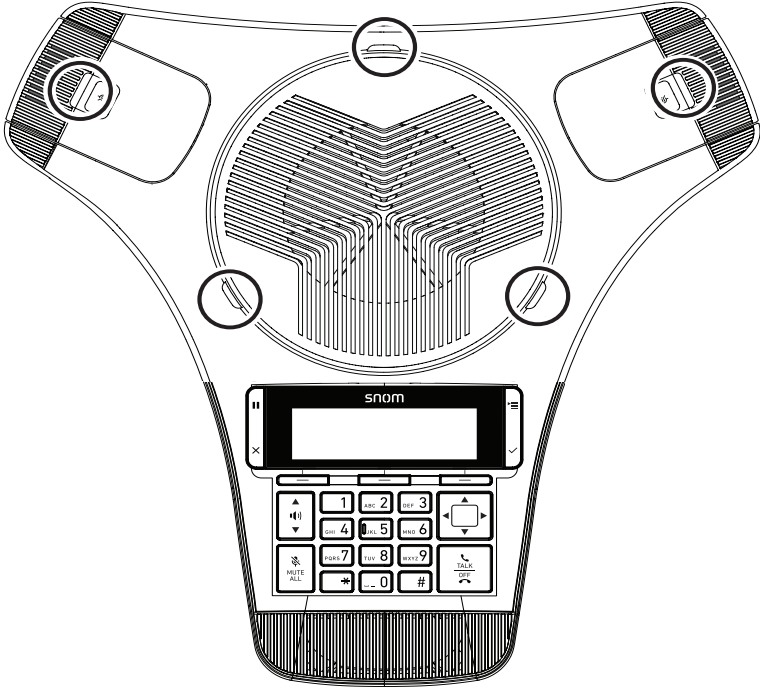

Function	Status indicator
Power up	<ul style="list-style-type: none">Steady Orange for five seconds.
On a call	<ul style="list-style-type: none">Steady Green during a call.Steady Red when a call is muted, or if there are new messages.
Incoming call	<ul style="list-style-type: none">Flashes Green quickly when there is an incoming call.
Charging	<ul style="list-style-type: none">Steady Orange while chargingSteady Orange for five seconds when charging completed and you connect the conference phone to the charging dock.Off when charging completed.
Low battery	<ul style="list-style-type: none">Flashes Orange slowly
Stand by	<ul style="list-style-type: none">Off when DECT linked; conference phone is idling; audio mode is not in use.

Getting started

Function	Status indicator
Registration	<ul style="list-style-type: none">• Flashes Red and Green alternately when DECT registration in progress.• Steady Green for five seconds when registration successful.• Steady Red for five seconds when registration failed or canceled.
Paged by base station	<ul style="list-style-type: none">• Flashes Green slowly
DECT Searching Mode	<ul style="list-style-type: none">• Flashes Red slowly when out of range or not registered.
Reset mode	<ul style="list-style-type: none">• Steady Orange
CEC battery testing mode	<ul style="list-style-type: none">• Flashes Red

Getting started

Status indicators on the base station

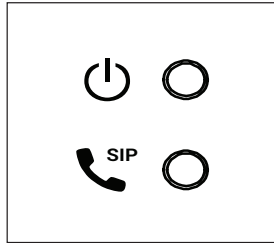

Power LED

VoIP LED

Power up	<ul style="list-style-type: none">• Power LED is Steady Green.
Power down	<ul style="list-style-type: none">• Power LED is Off.
Deregistration	<ul style="list-style-type: none">• Power and VoIP LEDs flash Green quickly while ready to deregister devices.• Power and VoIP LEDs are Steady Green for five seconds after the deregistration confirmation has elapsed.• VoIP LED is Off when at least one SIP account is deregistered.
Registration	<ul style="list-style-type: none">• Power and VoIP LEDs alternately flash Green slowly when base negotiating or checking with provisioning server.• Power and VoIP LEDs flash Green slowly during device registration.• VoIP LED is Steady Green when no SIP account is unregistered.
Firmware Upgrade	<ul style="list-style-type: none">• Power and VoIP LEDs alternately flash Green quickly when firmware upgrade or configuration import in progress.

Getting started

Idle screen

The Idle screen appears after the phone is connected and configured for your SIP PBX service. The Idle screen indicates that you have no active or held calls.



From the Idle screen, you can press:

- **Dir** to view the directories that are available to you. See "Directory" on page 28.
- **Line** to select another line (account). When you make a call, the phone will use the selected line/account.
- **Call Log** to view the phone's call history. See "Call History" on page 33.

Note that the default Idle screen soft keys are shown above. Your phone's soft keys are programmable and may differ from what is listed here.

Idle mode screen icons

In idle mode, the following screen icons indicate your phone's current settings.

Icon	Status
	Signal strength (1 to 4 bars).
	Ringer is OFF, or temporarily off during a call.
	Do not disturb is ON.
	Call Forward Always is ON.
	Battery level of conference phone (1 to 3 bars, blink for battery empty).

Active call screen icons

During a call, the following screen icons indicate the call's status.

Icon	Status
	The conference phone is active.
	Microphone is muted on the conference phone and wireless microphones.



Getting started

Icon	Status
1/2	Call counter - more than one call is active.
	More than one call is active. Press ▲ or ▼ to view another call.

Using the Main Menu

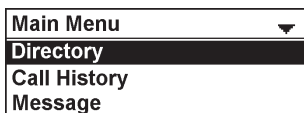
1. Press  to show the Main Menu.



2. Press ▼ or ▲ to highlight menu items.
3. Press  to select a highlighted menu item.
4. Press  or an appropriate soft key to save changes.
5. Press  to cancel an operation, exit the menu display or return to the idle screen.

Main menu items

- Directory (see page 28)
- Call History (see page 33)
- Message (see page 25)
- Call Features (see page 38)
- Status & Settings (see page 42)

Getting started

Input Modes

When you dial a phone number, the input mode is always numerals.

When you edit directory entries, the current input mode is indicated by the label of the middle softkey. For example, **ABC** for uppercase letters.

To switch to the next input mode, press the middle softkey underneath the display.



ABC = Uppercase letters

123 = Numerals

abc = Lowercase letters

Entering numerals, letters, and symbols

When entering letters and special characters, pause briefly after each character until the cursor has moved forward so that you won't overwrite the last character you entered. Pausing is not necessary when entering numerals.

Numerals:

- When entering numerals, press the respective number key to type the number printed on the key.



Letters and Symbols:

- To switch between entering uppercase and lowercase letters, press the middle softkey until its label displays **ABC** or **abc**.
- When entering letters, press the alphanumeric key (**2-9**) with the respective letter one, two, three, or four times quickly to type the first, second, third, or fourth letter printed on the key. Pause briefly after each letter.

Example: When entering lowercase letters, press the "2" key once to type an "a", twice to type a "b", and three times to type a "c".

- When entering special characters and symbols, press the alphanumeric key (**0-9, *, #**) as many times as needed. Pause briefly after each character or symbol. To see a list of symbols and which key to press, refer to the tables on the next page.

Getting started

Input mode **ABC** :

	1x	2x	3x	4x	5x	6x	7x	8x	9x	10x	11x
1	~	^	`	%	!	&	-	_	+	=	
2	A	B	C	Æ	À	Á	Â	Ç	Œ		
3	D	E	F	È	É	Ê	Ë				
4	G	H	I	Í	Î	Ï					
5	J	K	L								
6	M	N	O	Ó	Ô	Ñ					
7	P	Q	R	S							
8	T	U	V	Ù	Ú	Û	Ü				
9	W	X	Y	Z	ÿ						
0	space	:	;	,	?						
✕	.	@	✕								
#	()	[]	{	}	<	>	/	\	#

Examples:

- Press the **1** key six times quickly to type the **&** character.
- Press the **2** key eight times quickly to type the **Ç** character.
- Press the **0** key once to type the space character.
- Press the **✕** key three times quickly to type the **✕** character.

Input mode **abc** :

	1x	2x	3x	4x	5x	6x	7x	8x	9x	10x	11x
1	~	^	`	%	!	&	-	_	+	=	
2	a	b	c	æ	à	á	â	ç	œ		
3	d	e	f	è	é	ê	ë				
4	g	h	i	í	î	ï					
5	j	k	l								
6	m	n	o	ó	ô	ñ					
7	p	q	r	s							
8	t	u	v	ù	ú	û	ü				
9	w	x	y	z	ÿ						
0	space	:	;	,	?						
✕	.	@	✕								
#	()	[]	{	}	<	>	/	\	#

Conference phone operation

Making calls



You can make a call at any time by pressing  and then entering the number on the keypad. When the phone is in idle mode or has calls on hold, you can make a call

by entering the phone number on the keypad and then pressing  or **Dial** to call the number.

Making a call:



1. Press  on the conference phone.

You will hear a dial tone.

2. Enter the phone number on the keypad.



- Press **Backspc** to delete an incorrect digit.

3. Press **Dial** or, if the number is valid, the phone dials the number after a short delay.



When the call is answered, the active call screen appears. The screen displays the elapsed time as you talk (in hours, minutes, and seconds).



Note that the default active call screen soft keys are shown above. Your phone's soft keys are programmable and may differ from what is shown here.

Conference phone operation

Making a call in idle mode or with call(s) on hold:

1. Enter the phone number on the keypad.



- Press **Backspc** to delete an incorrect digit.



2. Dial the number by pressing

When the call is answered, the active call screen appears.



Note that the default active call screen soft keys are shown above. Your phone's soft keys are programmable and may differ from what is shown here.

Using a wireless microphone during a call

1. Take the wireless microphone from the phone's charging cradle and place it on the table near the intended person(s).
2. Speak towards the microphone.
 - For best performance, the person speaking should be at a distance of no more than 3 feet (91 cm).
 - Always return the wireless microphones to the charging cradles after use.

Ending the call



- To end the call, press **TALK OFF** or **End**.

Answering a call



On the phone, press **TALK OFF** or **Answer**.



On the incoming call screen, you can also press **Reject** to terminate the incoming call.

Conference phone operation

Call waiting

If you are on a call, and receive an incoming call from an outside number, the handset displays the Call Waiting screen. If you answer the call, your active call will be put on hold.



To answer the incoming call:

- Press **Reject** to terminate the incoming call.
- Press **Answer** to put the current call on hold and take the new call.
- Press ▼ or ▲ at any time to switch back and forth between calls. The call indicator (1/2, 2/2) shows which call is currently displayed.



Missed calls

If you don't respond to an incoming call, the phone displays a missed-call alert screen.









If a missed call alert screen appears, you can press:

- **Exit** to return to the Idle screen.
- **Callback** to immediately dial the caller's number. If there is more than one missed call, your phone dials the number of the most recently missed call.
- **View** to display the Call History screen. Press  twice to see the caller's information.



Conference phone operation

Redialing a call

1. When the phone is idle, press .
2. Press  or  to highlight **Call History**, then press .
3. Press  or  to highlight **Dialed Calls**, then press .

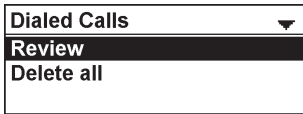
The Dialed Calls screen appears.





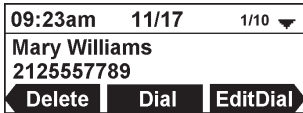

4. With **Review** selected, press .
5. Press  and  to select the number you want to redial.



6. Press **Dial** or .

Adjusting call volume

During a call, press   or   to adjust the listening volume (1-9).

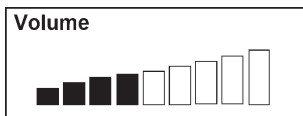



NOTE: When the volume reaches the minimum or maximum setting, you hear a beep.

Muting active calls



The mute function enables you to hear the other party, but the other party cannot hear you.

To mute all microphones:

- During a call, press **MUTE ALL** on the conference phone or press  on a wireless mic. The status indicators turn red, and the  symbol appears.

Conference phone operation

To end mute of all microphones:

- Press **MUTE ALL** on the conference phone or press  on a wireless mic.
The status indicators turn green, and the  symbol disappears.

Temporarily silencing the ringer

When the conference phone is ringing, you can temporarily silence the ringer without disconnecting the call. The next call rings normally at the preset volume.

To silence the ringer:

- Press **MUTE ALL** on the conference phone.
The  symbol appears.

NOTE: The conference phone rings when there is an incoming call unless the ringer volume of the conference phone is turned off.





Putting a call on hold

Use this feature to hold one call while you access another. The phone also puts calls on hold automatically when you answer another call by pressing the **Answer** key, transfer a call, or create a conference.

During a call, press . The On hold screen appears.



From the **On hold** screen, you can press:

-  and  to select a call (if you have a call on hold and another call active or on hold).
-  and  to see the different softkeys available.
- **End** to end the call.
- **New** to dial a new call.
See "Making a call in idle mode or with call(s) on hold:" on page 17
- **Resume** to take the call off hold.
- **Transfer** to transfer the held call to another party.
See "Transferring calls" on page 21.
- **Conf.** to start a conference with the held call.
See "To create a conference with a held call:" on page 24

Note that the default On hold screen soft keys are shown above. Your phone's soft keys are programmable and may differ from what is shown here.

Conference phone operation

If another party puts you on hold, you may see the message **Held by far end**.

This message depends on compatibility between phones and PBX types, and may not always appear. Press **End** to end the call.



Transferring calls

You can transfer a call to someone else at another phone.

If you talk to the transfer recipient before completing the transfer, you are making an **Attended transfer** (also called a **Supervised transfer**).

However, the transfer recipient does not have to talk to you before receiving the transferred call. If you do not talk to the transfer recipient before transferring the call, you are making a **Blind transfer**.

You can also transfer a call to a held call.

To transfer a call (Attended transfer):

1. During a call, press **Transfer**.
The Transfer to menu appears.

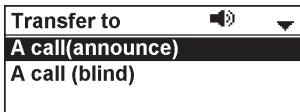

2. With **A call(announce)** highlighted, press .
3. Enter the number to which you want to transfer the call, and either press **Dial** or wait for the phone to dial automatically.
4. When the second call is established, you can talk to the party to notify them of the transfer, then press **Transfer** to transfer the call.



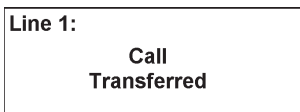

The **Call transferred** screen appears, and your phone returns to idle mode.



Conference phone operation



To cancel the transfer:

- Press  on the Transfer To screen. The active call screen reappears.
-OR-
Press  on the dialing screen. The On hold screen reappears.
- Press **End** when the second call is active. You will hang up on the second call.

To transfer a call (Blind transfer):

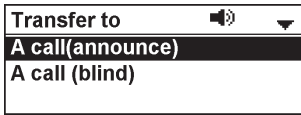
1. During a call, press **Transfer**.
The Transfer to menu appears.



2. Press  or  to highlight **A call (blind)**, then press .
3. Dial the number to which you want to transfer the call, and press **Dial**.

The **Call transferred** screen appears, and your phone returns to idle mode.



To transfer a call to a held call:

1. During a call, press **Transfer**.
The call is automatically put on hold, and the Transfer to screen appears, showing the held call.

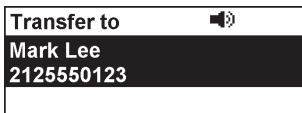

2. Press  to transfer the call to the held call.
The Call transferred screen appears, and your phone returns to idle mode.

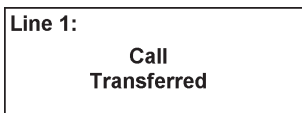

Conference phone operation

Making a conference call

You can hold a conference call between yourself and two other callers.

To make a conference call using manual entry:

1. During a call, press **Conf.**.
The call is automatically put on hold and the Conference with screen appears.



2. Enter the number for the party you want to join your conference, and press **Dial** or wait until phone dials automatically.
3. When the second call is established, you can talk to the party to advise them of the conference call.
4. Press **Conf.**.
The conference begins and the conference screen appears.

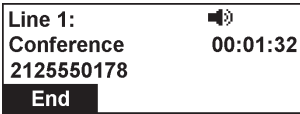



To make a conference call using the directory or call history:

1. During a call, press **Conf.**.
The call is automatically put on hold and the Conference with screen appears.

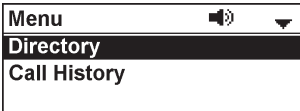

2. Press .
3. Press **▼** or **▲** to highlight **Directory** or **Call history**, and press .



4. Press **▼** or **▲** to highlight the directory or call history you want to access, and press .

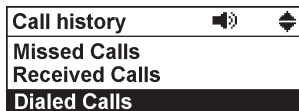

Conference phone operation

5. For call history, press ▼ or ▲ to highlight **Review**, and press .

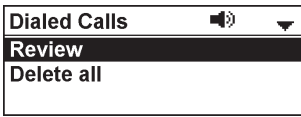

6. Press ▼ or ▲ to select the party you want to join your conference.

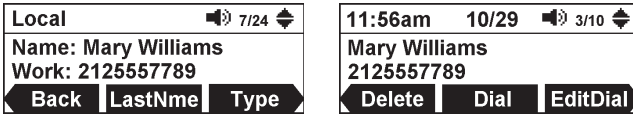

7. Press **Dial** or .

Your phone calls the number.

8. When the second call is established, you can talk to the party to advise them of the conference call.
9. Press **Conf.**

The conference begins and the conference screen appears.

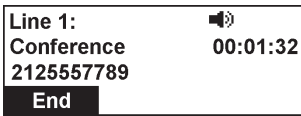

To cancel the conference:

- Before dialing the second call: Press  on the Conference with screen. Press **Resume** to resume the held call.
- With the second call on the line: Press **End**. Press **Resume** to resume the held call.

To create a conference with a held call:

When you have an active call and a held call, you can also create a conference with the held call.

1. During a call, press **Conf.**
- The Conference with screen appears, showing the held call.



2. Press .

The conference begins and the conference screen appears.

Conference phone operation



Ending a conference call:

- Press **End** to hang up on both calls.

Setting up a network conference

A network conference is hosted by your service provider and allows multiple parties to join a conference. A Network Conference works in a similar way to the regular conference described above.

In addition, the soft keys **Add** and/or **AddCall** will appear during a conference, allowing you to add more parties to the ongoing conference call.

Retrieving messages

The conference phone displays the New Message(s) alert screen when you have a new voicemail message.



On the New Message(s) alert screen, you can press:

- **Exit** to return to the idle screen.
- **View** to access your messages. The Message Menu appears.

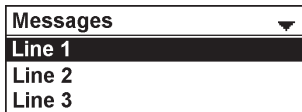



The message menu displays the mailboxes you can access from your phone. If your phone has more than one line, you may be able to access multiple mailboxes.

Press ▲ or ▼ to highlight the desired mailbox, and press  to access messages in that mailbox.

When there is no New Message(s) alert screen, you can access the Message menu using the phone menu.

Conference phone operation

To view the Messages menu:

1. When the phone is idle, press 
2. Press ▼ or ▲ to highlight **Message**, then press .

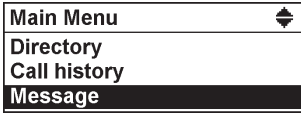

The Message menu appears.

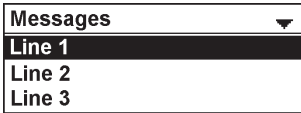

3. Press ▼ or ▲ to highlight a line, then press .
- Your conference phone dials the voicemail retrieval number.

Conference phone operation

Paging

This feature helps you find the conference phone and any misplaced wireless mics within the range of the base unit.

To start the paging tone:

- Press the LINK key on the base station.

The Paging screen appears.



- The conference phone rings and the status indicators flash green.
- If the wireless mic is not in its cradle, the wireless mic beeps and the status indicator flashes red.

To mute the paging tone:

- Press **Silence** on the conference phone.

-OR-

Press  (MUTE ALL) on the wireless mic or conference phone.

-OR-

Place the wireless mic in its cradle.

To stop the paging tone:

- Press the LINK key on the base station.

-OR-

Press **Stop** on the conference phone.

Note: The paging tone automatically stops after 60 seconds has elapsed.

Directory

About the directory

The Directory menu enables you to store names and phone numbers in four types of directories:

- **Local** – available only on your conference phone.
- **Base** – available on all conference phones in your system.
- **Blacklist** – contains blocked numbers, and is available on all conference phones in your system.
- **Broadsoft directory** – enables access to your Broadsoft directories - Group, Group Common, Enterprise, Enterprise Common, or Personal.

Once directory entries are saved, you can dial them directly from the directory. You can also search directory entries by first or last name.

When adding an entry, you can enter numbers for work, mobile, and other. You can also select a ringtone and default line for that contact. Later, you can edit entries if their contact information changes.

Viewing a directory

1. Press .

The Main Menu appears

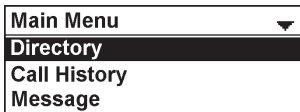

2. With **Directory** highlighted, press .

The Directory menu appears, listing all your available directories. Any directories other than Local are server-based and will vary with your installation. You can edit the Local directory, Base directory, and the Blacklist.

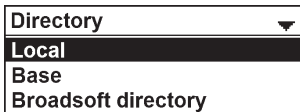

3. Press ▲ or ▼ to select the directory you wish to view, and then press .

The selected directory appears, showing the first entry (sorted alphabetically by first name).





4. Press ▲ or ▼ to view other entries.

Directory

The following soft keys are available when viewing a directory entry. Press ◀ or ▶ to view the desired softkeys.

Back	Returns to Directory list screen	LastName	Sorts the list by last name / first name from the top of the list	Type	Displays the contact's other numbers: Work, Mobile, Other
		FirstName			
Dial	Dials the entry	Edit	Enables you to change the entry	Search	Enables you to search the list alphabetically by first or last name
Add	Enables you to add a new entry	Delete	Deletes the entry	Del. all	Deletes all entries

Adding a directory entry

1. Press .
2. With **Directory** highlighted, press .
3. Press ▲ or ▼ to select the directory you want, and then press .
4. If the message "... directory is empty. Add new entry?" appears, press **Yes**. Otherwise, press ◀ or ▶ until the **Add** softkey appears, and then press **Add**.

The Add new screen appears.

Add new 1/25 ▼







First Name:
_

Backspc | **ABC** | **Next**

5. Use the keypad to enter the First name, Last name, Work, Mobile, and Other numbers. Press **Next** after entering each item.
 - To move the cursor left or right, press ◀ or ▶.
 - To erase a character/digit, press **Backspc**.
 - To move to the next item, press ▼ or **Next**.
 - To move back to the previous item, press ▲.
6. Press ◀ or ▶ to select a Ringer tone, and then press **Next**.
7. Press ◀ or ▶ to select a line.
8. To save the directory entry, press **Save**.







Directory

Reviewing directory entries

1. Press .
2. With **Directory** highlighted, press .
3. Press  or  to select the directory you want, and then press .
4. Press  or  to browse through the directory entries.

NOTE: When the directory is empty, the conference phone displays "... directory is empty. Add new entry?"

Searching for a directory entry

1. Press .
2. With **Directory** highlighted, press .
3. Press  or  to select the directory you want, and then press .
4. Press  or  until the **Search** softkey appears.
5. Press **Search**.

The keyword search screen appears.



6. Use the dial pad keys to enter the first few characters of the name to be searched.
7. Press **Next**.

Dialing a directory entry

1. Search for the desired entry in the directory (see "Reviewing directory entries" on page 30 or "Searching for a directory entry" on page 30).
2. To view other numbers for the entry, press **Type**.



3. When the desired number appears, press  or **Dial**.

Note: If you view a directory entry when the phone is in dial mode, press **Dial** to dial the number. You can use this feature when making a call and setting up a conference call.

Directory

Editing a directory entry

1. Search for the desired entry in the directory (see "Reviewing directory entries" on page 30 or "Searching for a directory entry" on page 30).
2. Press ◀ or ▶ until the **Edit** softkey appears.
3. Press **Edit**.

The Edit screen appears.



Edit ▼		
First Name: Mary		
Backspc	ABC	Next

4. Press ▲ or ▼ to select an item to edit.
5. Use the keypad to change the First name, Last name, Work, Mobile, and Other numbers. Press **Next** after entering each item.
 - To move the cursor left or right, press ◀ or ▶.
 - To erase a character/digit, press **Backspc**.
 - To move to the next item, press ▼ or **Next**.
 - To move back to the previous item, press ▲.
6. Press ◀ or ▶ to change the Ringer tone, and then press **Next**.
7. Press ◀ or ▶ to change the line.
8. To save your changes, press **Save**.

Deleting a directory entry

1. Search for the desired entry in the directory (see "Reviewing directory entries" on page 30 or "Searching for a directory entry" on page 30).
2. Press ◀ or ▶ to until the **Delete** softkey appears.
3. Press **Delete**.

A confirmation screen appears.

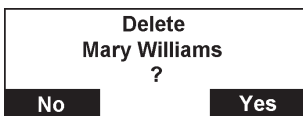

Delete	
Mary Williams	
?	
No	Yes

4. Press **Yes**.

Directory

Deleting all directory entries

1. From a directory entry, press ◀ or ▶ until the **Del. all** softkey appears.
2. Press **Del. all**.

A confirmation screen appears.



3. To confirm deletion, press **Yes**. To cancel deletion, press **No**.

Call History

Call history

The call history provides available name and number information for incoming and outgoing calls. The newest entries replace the oldest. You can view call history information for:





- Missed calls—incoming calls that were not answered.
- Received calls—incoming calls that you answered or silenced.
Maximum 200 entries of combined Missed calls and Received calls.
- Dialed calls—all outgoing calls. You can use this as a redial list.
Maximum 10 entries.

Reviewing call history

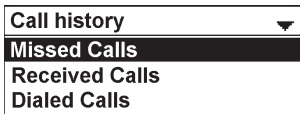
1. Press .
2. Press  or  to highlight **Call history**, then press .

The Call history screen appears.



3. Press  or  to highlight the desired call history folder, then press .
4. With **Review** highlighted, press .

The first entry appears.

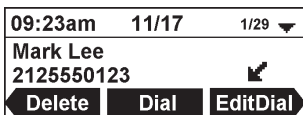

If the folder is empty, the message "No entries to display" appears.

5. Press  or  to view more entries.

The call history entry screen shows the time, date, name and number of the call, the number of entries in the folder, along with an icon indicating the type of call.



Call History

The following soft keys are available when viewing a call history entry. Press ◀ or ▶ to view the desired softkeys.

Delete	Deletes the entry	Dial	Dials the entry	Edit Dial	Displays the predial screen so you can edit the number before dialing
Save	Saves the call information to the local directory				

Dialing a call history entry

1. Search for the desired call history entry (see "Reviewing call history" on page 33).



2. While viewing the desired entry, press  or **Dial**.

The phone dials the number immediately.

-OR-

Press **Edit Dial**. The predial screen appears, allowing you to edit the number before pressing **Dial**.

- Press **Backspc** to delete a digit.

Note: If you view a call history entry when the phone is in dial mode, press **Dial** to dial the number. You can use this feature when making a call and setting up a conference call.

Saving a call history entry to the directory

1. While viewing the desired entry, press ◀ or ▶ until the **Save** soft key appears.

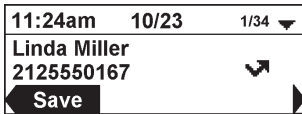

2. Press **Save**.
3. On the **Save to** menu, select the location to which you want to save the entry.



Call History

The Add new screen appears. The phone automatically fills in the name and number, if available.





Add new ▼		
First Name: Linda		
Backspc	ABC	Next

- If necessary, edit the name and number.
 - To erase a character/digit, press **Backspc**.
 - To move to the next item, press ▼ or **Next**.
- Press ◀ or ▶ to change the line.
- To save the directory entry, press **Save**.

Deleting a call history entry

- Search for the desired call history entry (see "Reviewing call history" on page 33).
- While viewing the desired entry, press **Delete**.

Deleting all call history entries

- When the phone is idle, press .
- Press ▲ or ▼ to highlight **Call history**, then press .
- Press ▲ or ▼ to highlight the desired call history folder, then press .
- Press ▲ or ▼ to highlight **Delete all**, then press .

A confirmation screen appears.

Delete all entries in Dialed Calls ?

- To confirm deletion, press . To cancel deletion, press .

Speed dial

Speed dial

The speed dial menu enables you to enter up to 10 numbers that you dial frequently.

Dialing a speed dial number

- When the conference phone is not in use, press and hold a dialing key (**0-9**) that matches the speed dial entry number (for entry 10, press and hold **0**).

Adding a speed dial entry

1. Press .

2. With **Directory** highlighted, press .

3. Press **▲** or **▼** to highlight **Speed Dial**, and then press .

The Speed Dial menu appears.

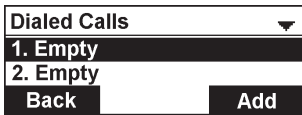

4. Press **▲** or **▼** to highlight a speed dial entry marked "Empty."

5. Press **Add**.

6. Use the keypad to change the Name and Number.

Press **Next** after entering each item.

- To move the cursor left or right, press **◀** or **▶**.
- To erase a character/digit, press **Backspc**.
- To move to the next item, press **▼** or **Next**.
- To move back to the previous item, press **▲**.

7. Press **◀** or **▶** to change the line, and then press **Next**.

8. To save the speed dial entry, press **Save**.

Editing a speed dial entry

1. Press .

2. With **Directory** highlighted, press .

3. Press **▲** or **▼** to highlight **Speed Dial**, and then press .



4. Press **▲** or **▼** to highlight the speed dial entry you want to reassign.

5. Press **Edit**.

Speed dial

- Use the dial pad keys to change the Name and Number.
Press **Next** after entering each item.
 - To select a character/digit, press ◀ or ▶.
 - To erase a character/digit, press **Backspc**.
 - To move to the next item, press ▼ or **Next**.
 - To move back to the previous item, press ▲.
- Press ◀ or ▶ to change the line, and then press **Next**.
- To save your changes, press **Save**.

Deleting a speed dial entry

- Press .
- With **Directory** highlighted, press .
- Press ▲ or ▼ to highlight **Speed Dial**, and then press .
- Press ▲ or ▼ to highlight the speed dial entry you want to delete.
- Press **Delete**.

A confirmation screen appears.

Delete Mary Williams ?	
No	Yes

- Press **Yes**.





Settings

You can change the conference phone settings from the Call Features menu (see below) and the User Settings menu (see page 42).

The following pages describe how to change the conference phone settings from both menus.





Call Features Menu

To display the Call Features menu:

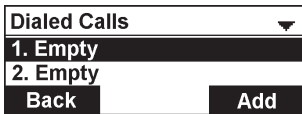
1. Press  when the conference phone is not in use.
2. Press  or  to highlight **Call Features**, and then press .

The Call Features menu appears.



3. Press  or  to highlight menu items.
4. Press  to select a highlighted menu item.
5. Press  to save changes.
6. Press  to cancel an operation or return to the previous menu.

Call Features menu items

- Do Not Disturb (see page 39)
- Call Forwarding (see page 39)
- Block Anonymous (see page 41)
- Dial as Anonymous (see page 41)
- Missed Call Alert (see page 42)
- Call Waiting Alert (see page 42)

Settings

Setting Do Not Disturb (DND)

You can set Do Not Disturb (DND) for each line assigned to your phone. When DND is set, the ringer is silenced and the phone rejects incoming calls and pages; the caller receives the busy signal. After rejecting a call, the phone displays the Missed Calls screen.

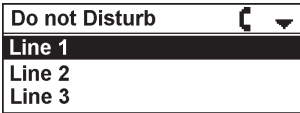

To turn DND on or off:

1. From the Call Features menu, press ▲ or ▼ to highlight **DND**, and then press .
The Do not Disturb menu appears.

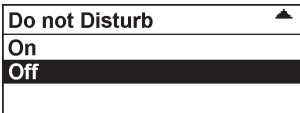

2. Press ▲ or ▼ to highlight the desired line, and then press .
3. Press ▼ or ▲ to highlight **On** or **Off**.



4. Press  to save your selection. You will hear a confirmation tone.
When DND is on,  appears on the idle screen.

Setting Call Forwarding

Call forwarding automatically forwards incoming calls depending on the setting. You can enable the following types of call forwarding:

- **Always:** incoming calls are forwarded immediately and the phone does not ring.
- **Busy:** incoming calls are forwarded if all your available lines are busy.
- **No answer:** incoming calls are forwarded after the no answer delay expires.

To set call forward:

1. From the Call Features menu, press ▲ or ▼ to highlight **Call forwarding**, and then press .
The Call forward menu appears.

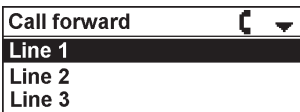

Settings

2. Press ▲ or ▼ to highlight the line for which you want to configure call forward settings, and then press .
3. Press ▼ or ▲ to highlight the desired option:
 - Always
 - Busy
 - No answer

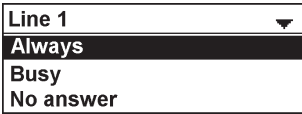

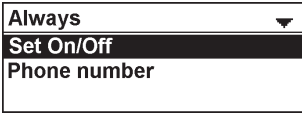

4. Press .
5. On the next screen, with **Set On/Off** highlighted, press .

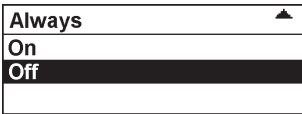

6. Press ▼ or ▲ to highlight **On** or **Off**, and then press .



7. Press ▼ or ▲ to highlight **Phone number**, and then press .
8. Enter the phone number to which you would like to forward calls.
 - To erase a digit, press **Backspc**.
9. To save your call forward settings, press **Save**.
You will hear a confirmation tone.
10. If you selected No answer earlier, press ▼ or ▲ to highlight **No ans. delay**, and then press .
11. Press ▼ or ▲ to highlight the No Answer delay between 1 and 10 rings, and then press .

When Call forward Always is on,  appears on the idle screen.

Settings

Setting Block Anonymous

Block Anonymous enables the phone to reject incoming calls that have no caller ID.

To set block anonymous:

1. From the Call Features menu, press ▲ or ▼ to highlight **Block anonymous**, and then press .

The Block Anonymous menu appears.



2. Press ▲ or ▼ to highlight the desired line, and then press .
3. Press ▼ or ▲ to highlight **On** or **Off**.

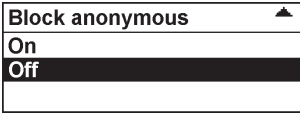

4. Press  to save your selection. You will hear a confirmation tone.

Setting Dial as Anonymous

Dial as Anonymous enables the phone to make outgoing calls with the Caller ID hidden from the far end.

To set dial as anonymous:

1. From the Call Features menu, press ▲ or ▼ to highlight **Dial as anonyms**, and then press .

The Dial as anonyms menu appears.

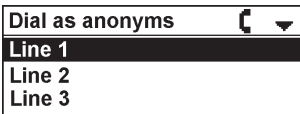

2. Press ▲ or ▼ to highlight the desired line, and then press .
3. Press ▼ or ▲ to highlight **On** or **Off**.

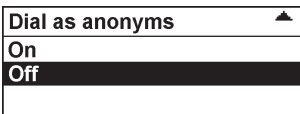

4. Press  to save your selection. You will hear a confirmation tone.

Settings

Setting Missed Call Alert

The Missed call alert setting enables the phone to display the missed call alert screen (see "Missed calls" on page 18).

To set missed call alert:

1. From the Call Features menu, press ▲ or ▼ to highlight **Miss call alert**, and then press .
2. Press ▼ or ▲ to highlight **Show alert** or **Hide alert**.

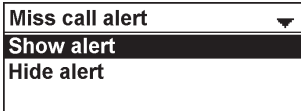

3. Press  to save your selection. You will hear a confirmation tone.

Setting Call Waiting alert

The Call waiting setting enables or disables incoming call alerts while you are on another call.

To set call waiting alert:

1. From the Call Features menu, press ▲ or ▼ to highlight **Call waiting**, and then press .
2. Press ▼ or ▲ to highlight **Show alert** or **Hide alert**.

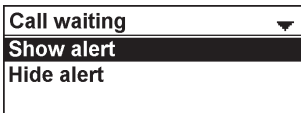

3. Press  to save your selection. You will hear a confirmation tone.

User Settings menu

To display the User Settings menu:

1. Press  when the conference phone is not in use.

The Main Menu appears

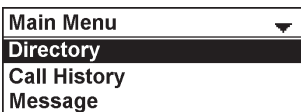

Settings

2. Press ▼ or ▲ to highlight **Status & Settings**, and press .

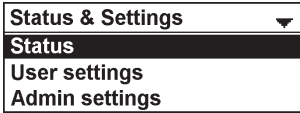

The Status & Settings menu appears.

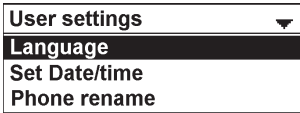

3. Press ▼ or ▲ to highlight **User settings**, and press .

The User settings menu appears.



4. Press ▼ or ▲ to highlight menu items.
5. Press  to select a highlighted menu item.
6. Press  to save changes.
7. Press  to cancel an operation or return to the previous menu.

User Settings menu items

- Language (see page 43)
- Set Date/Time (see page 44)
- Phone rename (see page 45)
- Display (see page 46)
- Audio (see page 47)
- Registration (see page 50)

Setting Language

You can select English, French, or Spanish to be used in the conference phone screen display.

To set the language:

1. From the User settings menu, press ▲ or ▼ to highlight **Language**, and then press .

The Language menu appears.

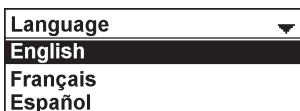

Settings

2. Press ▲ or ▼ to select the desired language.
3. Press  to save your selection. You will hear a confirmation tone.

Setting Date and time

Before using the C620, set the date and time as follows. The date and time will be displayed on the conference phone when idle.

To set the date format:

1. From the User settings menu, press ▼ or ▲ to highlight **Set Date/Time**, and then press .

The Set Date/Time menu appears.

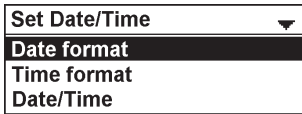

2. With **Date format** highlighted, press .

The Date format screen appears.

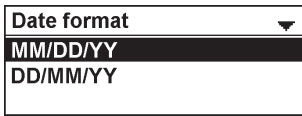

3. Press ▼ or ▲ to select the desired date format (MM/DD/YY or DD/MM/YY).
4. Press  to save your selection. You will hear a confirmation tone.

To set the time format:

1. From the User settings menu, press ▼ or ▲ to highlight **Set Date/Time**, and then press .

2. Press ▼ or ▲ to highlight **Time format**, and then press .

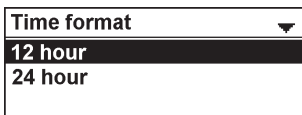

The Time format screen appears.



3. Press ▼ or ▲ to select the desired time format (12 hour or 24 hour).
4. Press  to save your selection. You will hear a confirmation tone.

Settings

To manually set the date and time:

1. From the User settings menu, press ▼ or ▲ to highlight **Set Date/Time**, and then press .
2. Press ▼ or ▲ to highlight **Date/Time**, and then press .
3. On the Set date screen, enter the date.



- The currently selected month/day/year is flashing.
 - Use the dialing keys to enter a two-digit number, or press ▲ or ▼ to select a number.
The conference phone beeps twice if you enter an invalid number.
 - To move to the next number, press **Next**.
 - To move to the previous number, press **Back**.
4. On the Set time screen, enter the time.

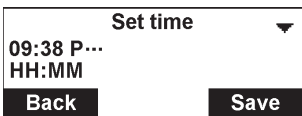

- The currently selected hour/minute is flashing.
 - Use the dialing keys to enter a two-digit number, or press ▲ or ▼ to select a number.
The conference phone beeps twice if you enter an invalid number.
 - To move to the next number, press **Next**.
 - To move to the previous number, press **Back**.
 - For 12-hour time format, press ▲ or ▼ to select ... (AM) or P... (PM).
5. Press **Save** to save your selection. You will hear a confirmation tone.

Renaming the phone

You can rename the conference phone from the default "SPEAKER BOX".

To rename the conference phone:

1. From the User settings menu, press ▼ to highlight **Phone rename**, and then press .
- The Phone rename screen appears.

Settings



2. Use the dialing pad to enter the new name.
 - To delete a character, press **Backspc**.
3. Press **Save** to save your selection. You will hear a confirmation tone.

Setting the display settings

Use the display menu to set the screen appearance and backlight behavior.

To set the contrast:

1. From the User settings menu, press ▼ or ▲ to highlight **Display**, and then press .

The Display menu appears.



2. With **Contrast** highlighted, press .

The Contrast screen appears.



3. Press ▼ or ▲ to select the desired contrast level (1 to 7).
4. Press  to save your selection. You will hear a confirmation tone.

To set backlight:

1. From the User settings menu, press ▼ or ▲ to highlight **Display**, and then press .

2. press ▼ or ▲ to highlight **Backlight On**, **BackLight Idle**, or **Timeout***, and then press .

- If you selected **Backlight On** or **BackLight Idle**, press ▼ or ▲ to select **On** or **Off**.
- If you selected **Timeout**, press ▼ or ▲ to choose the timeout period between 10 and 60 seconds.

Settings

Being triggered ▼ On Off	During idle ▲ On Off	Backlight Time ▼ 10 seconds 15 seconds 20 seconds
--------------------------------	----------------------------	------------------------------------------------------------

3. Press  to save your selection. You will hear a confirmation tone.

* NOTES:

- If **Backlight On** is off and **BackLight Idle** is on, the LCD backlight always lights up.
- If **Backlight On** is on and **BackLight Idle** is off, the LCD backlight turns off after being idle for as long as the set **Timeout** period.
- If **Backlight On** and **BackLight Idle** are both off, the LCD backlight is always off.

Setting the audio settings

Use the audio menu to set the ringer tone and advisory tones for low battery, link lost, key press, hold reminder tone, and on cradle tone.

To set the ringer tone:

1. From the User settings menu, press ▼ or ▲ to highlight **Audio**, and then press .

The Audio menu appears.

Audio ▼ Ringer Tone Advisory Tones

2. With **Ringer Tone** highlighted, press .

The Ringer Tone screen appears.

Ringer Tone  ▼ Line 1 Line 2 Line 3

3. Press ▲ or ▼ to highlight the desired line, and then press .

4. Press ▼ or ▲ to sample each ringer tone (Melody 1 to Melody 10).

Line 1  Melody 5 Melody 6 Melody 7

5. Press  to save your selection. You will hear a confirmation tone.

Settings

To set the ringer volume:



When the phone is idle, press  or  to change the ringer volume level as desired.

To set the low battery tone:

1. From the User settings menu, press  or  to highlight **Audio**, and then press .

2. press  or  to highlight **Advisory Tones**, and then press .

The Advisory Tones screen appears.

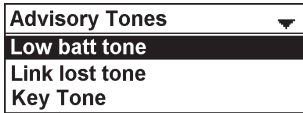

3. With **Low batt tone** highlighted, press .

4. Press  or  to select **On** or **Off**.

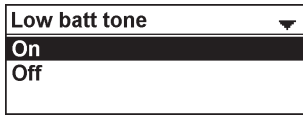

5. Press  to save your selection. You will hear a confirmation tone.

To set the link lost tone:

1. From the User settings menu, press  or  to highlight **Audio**, and then press .

2. Press  or  to highlight **Advisory Tones**, and then press .

3. Press  or  to highlight **Link lost tone**, and then press .

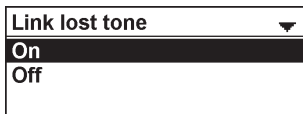

4. Press  or  to select **On** or **Off**.





5. Press  to save your selection. You will hear a confirmation tone.

Settings

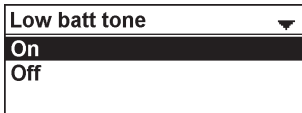

To set the key tone:

1. From the User settings menu, press ▼ or ▲ to highlight **Audio**, and then press .
2. Press ▼ or ▲ to highlight **Advisory Tones**, and then press .
3. Press ▼ or ▲ to highlight **Key Tone**, and then press .
4. Press ▼ or ▲ to select **On** or **Off**.



5. Press  to save your selection. You will hear a confirmation tone.

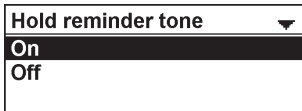

To set the hold reminder tone:

1. From the User settings menu, press ▼ or ▲ to highlight **Audio**, and then press .
2. Press ▼ or ▲ to highlight **Advisory Tones**, and then press .
3. Press ▼ or ▲ to highlight **Hold reminder tone**, and then press .
4. Press ▼ or ▲ to select **On** or **Off**.



5. Press  to save your selection. You will hear a confirmation tone.

To set the on cradle tone:

1. From the User settings menu, press ▼ or ▲ to highlight **Audio**, and then press .
2. Press ▼ or ▲ to highlight **Advisory Tones**, and then press .
3. Press ▼ or ▲ to highlight **On cradle tone**, and then press .
4. Press ▼ or ▲ to select **On** or **Off**.

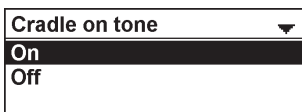

5. Press  to save your selection. You will hear a confirmation tone.

Registration

Registering the conference phone to the base

Your conference phone is pre-registered to the base station. If you need to manually re-register the conference phone, follow these steps:

1. Place the conference phone in the charging dock, and make sure it is connected to power.

2. If the conference phone is displaying



go to step 6.

3. If the conference phone is displaying

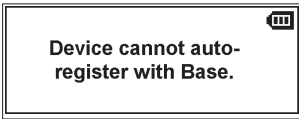

go to step 7.

4. If the conference phone is displaying

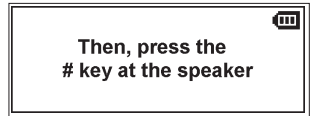
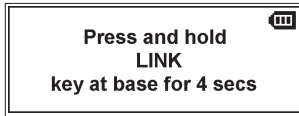
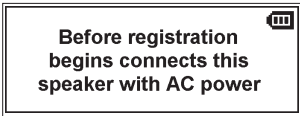

go to step 8.

5. If the conference phone is displaying



go to step 7.

6. Press **Cancel**.

The conference phone displays the following messages:

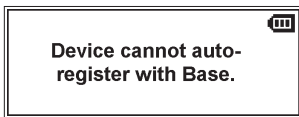

7. Press **Yes**.

The conference phone displays the following message:

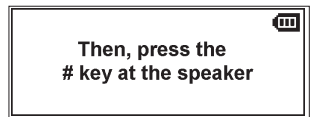
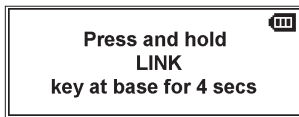
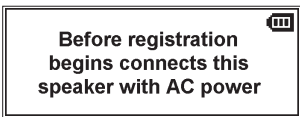





8. On the base station, press and hold the LINK key for 4 seconds. Both LEDs on the base station begin to flash.

Registration

9. Press the # key on the conference phone to begin registration.
The conference phone displays the message "Registering... please wait."
When registration is complete, the conference phone beeps and then displays "Speaker Registered."
If the conference phone fails to register, remove it from the charger for a few seconds, replace it in the charger, and repeat the registration procedure.

Deregistering the conference phone

1. Press .
2. Press ▼ or ▲ to highlight **Status & Settings**, and then press .
3. Press ▼ or ▲ to highlight **User Settings**, and then press .
4. Press ▼ or ▲ to highlight **Registration**, and then press .
5. Press ▼ or ▲ to highlight **Deregistration**, and then press .

Registration ▲
This Speaker
Wireless Microphone
Deregistration

6. Press ▼ or ▲ to highlight the <device name> of the conference phone.
For example, "SPEAKERBOX 1".

Deregistration ▼
SPEAKER BOX 1
MICROPHONE 2
MICROPHONE 3

7. Enter the PIN. Default PIN is 1590.





If deregistration is successful, the conference phone displays a message.
For example, "SPEAKER BOX 1 Handset is deregistered."

Registration

Registering the wireless mics to the base

Your wireless mics are pre-registered to the base station.

If you need to manually re-register the wireless mics, follow these steps:

1. Press .
2. Press ▼ or ▲ to highlight **Status & Settings**, and then press .
3. Press ▼ or ▲ to highlight **User Settings**, and then press .
4. Press ▼ or ▲ to highlight **Registration**, and then press .
5. Press ▼ or ▲ to highlight **Wireless microphone**, and then press .

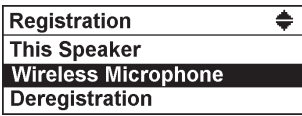



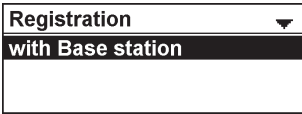

6. Press ▼ or ▲ to highlight **with Base station**, and then press .



7. Follow the instructions on the conference phone screen.
Press **NEXT** to move through the screens.
 - a. Connect the conference phone with AC power (by placing it in the charging dock).
 - b. Put one wireless mic on the conference phone charge cradle
 - c. Press and hold the LINK key on the base station for 4 seconds.
 - d. Press and hold the  key on the wireless mic for 3 seconds.
If registration is successful, the mic LED lights up in green for 5 seconds
If registration is unsuccessful, the mic LED lights up in red for 5 seconds.
8. To register the second wireless mic, repeat step 6 to 7.

Registration

Deregistering the wireless mics

1. Press .
2. Press **▼** or **▲** to highlight **Status & Settings**, and then press .
3. Press **▼** or **▲** to highlight **User Settings**, and then press .
4. Press **▼** or **▲** to highlight **Registration**, and then press .
5. Press **▼** or **▲** to highlight **Deregistration**, and then press .

Registration ▲
This Speaker
Wireless Microphone
Deregistration

6. Press **▼** or **▲** to highlight the wireless microphone you want to deregister.

Deregistration ▼
SPEAKER BOX 1
MICROPHONE 2
MICROPHONE 3

7. Enter the PIN. Default PIN is 1590.
If deregistration is successful, the conference phone displays a message.
For example, "MICROPHONE 3 Handset is deregistered."
8. To deregister another wireless mic, go to step 5.

Registration

Register a C52-SP DECT Expansion Speakerphone

You can register up to two C52-SP DECT Expansion Speakerphones to your C620 SIP Wireless Conference Phone.

If your organization uses DECT auto registration:

The C52-SP will automatically register to the C620. You do not need to take any further action.

If your organization does NOT use DECT auto registration (or if you are not sure):

You must first turn off auto registration on the C52-SP by performing the following steps:

1. Press and hold the **MUTE ALL** button on the C52-SP for five seconds.
2. Press and hold the **TALK/OFF** button on the C52-SP for five seconds.

The C52-SP LEDs turn steady orange for five seconds, then slowly flash orange.



At this point, you can manually register the C52-SP to the C620 by following the instructions below.

Manually register the C52-SP to the C620

1. Press and hold the REGISTRATION button on the bottom of the C52-SP unit for five seconds.

When you release the button, the C52-SP LEDs will flash red and green alternately. This indicates the C52-SP is ready for registration.

2. Press and hold the LINK key on the C620 base unit for four seconds.

The  and  LEDs flash green for about 10 seconds, then turn steady green.















If registration is successful, the LEDs on the C52-SP turn green for five seconds.

If registration fails, the LEDs on the C52-SP turn red for five seconds.

3. To register an additional C52-SP speakerphone, follow the instructions in "Register a C52-SP DECT Expansion Speakerphone", above.

Registration

Deregister a C52-SP DECT Expansion Speakerphone

1. Press .
2. Press  or  to highlight **Status & Settings**, and then press .
3. Press  or  to highlight **User Settings**, and then press .
4. Press  or  to highlight **Registration**, and then press .
5. Press  or  to highlight **Deregistration**, and then press .
6. On the Deregistration menu, press  to select **WIRELESS SPE**, and then press .
7. Enter the PIN. Default PIN Is 1590.
The conference phone displays the message "WIRELESS SPE X is deregistered."



Password warning on idle screen

The conference phone will display a warning message if the Administrator Password and/or User Password has not been changed from their default values. You must change these passwords in order to access the conference phone's WebUI pages.

**For security reason,
please edit the
User PW
Admin PW**

NOTE: You can press  on the conference phone to temporarily clear the warning message and display the idle screen. After 15 minutes, the warning message reappears.

To change the Administrator Password and User Password:

1. Press , and select **Status & Settings > Status > Network > IPv4 or IPv6**.
2. Press  to scroll down to display the **IP Address**.
3. Enter the IP address in the address bar of a web browser and press ENTER.
The Passwords page of the C620 WebUI appears.

Registration

SNOM
C620

STATUS SYSTEM NETWORK

Passwords

For security reason, please change the default password. Otherwise, the phone cannot be configured.

Administrator Password

Enter New Password:

Re-enter New Password:

User Password

Enter New Password:

Save

4. Enter and re-enter a new Administrator Password.
5. Enter a new User Password.
6. Click **Save**.

The WebUI page refreshes. You can now open pages on the WebUI.

Appendix

Conference phone battery

It takes up to 11 hours for the conference phone battery to be fully charged (the battery icon has 3 bars ). When the conference phone is fully charged, you can expect the following operating times:

Operation	Operating time
While the conference phone is in use (talking)	Up to 5 hours
he conference phone is not charging and not in use (standby)	Up to 7 days

The battery needs charging when:

- A new battery is installed into the conference phone.
- The battery icon has no bars and is flashing .

CAUTION:

To reduce the risk of fire or injury, read and follow these instructions:

- Use only the batteries provided or equivalent. To order a replacement, visit our website at snomamericas.com.
- Do not dispose of the batteries in a fire. Check with local waste management codes for special disposal instructions.
- Do not open or mutilate the batteries. Released electrolyte is corrosive and may cause burns or injury to the eyes or skin. The electrolyte may be toxic if swallowed.
- Exercise care in handling batteries in order not to create a short circuit with conductive materials.
- Charge the batteries provided with or identified for use with this product only in accordance with the instructions and limitations specified in this manual.
- Observe proper polarity orientation between the battery and metallic contacts.
- To prevent fire or shock hazard, do not expose this product to water or any type of moisture.

Battery disposal

Disposal of electrical and electronic products and of batteries should be done in line with local regulations. Please contact local authorities for further information.

Appendix

Factory reset the base station

1. Using a paperclip, or something similar, press and hold the reset button on the back of the base station for 15 seconds.
2. Release the reset button. During the next one to two minutes, the following occurs:
 - The conference phone displays "Please wait".
 - The VoIP LED on the base station flashes quickly, then the Power LED and the VoIP LED flash alternately.
 - The conference phone beeps once and displays "Out of range or no power at base".
 - The status indicators on the conference phone flash red quickly.
 - The conference phone displays the idle screen. This indicates the factory reset has completed.

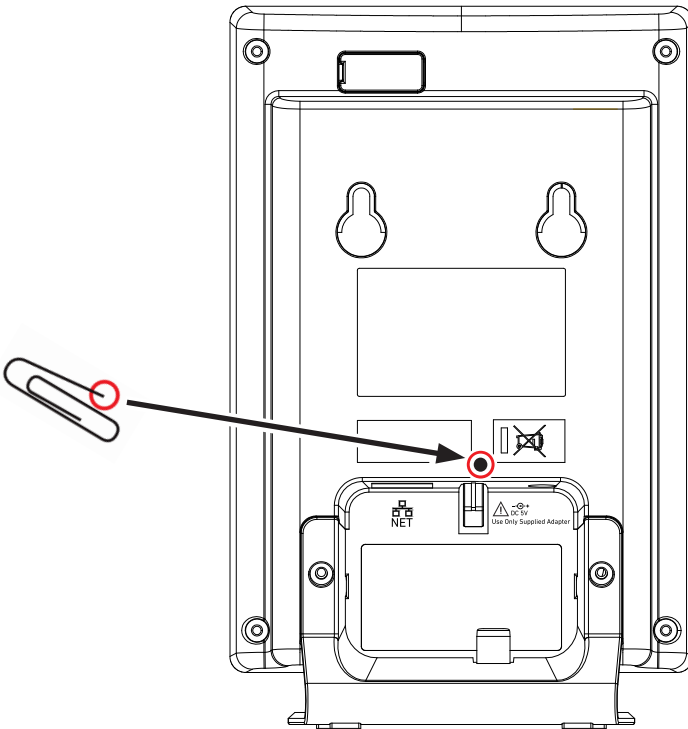

Troubleshooting

If you have difficulty with your conference phone, please try the suggestions below. For customer service, visit our website at snomamericas.com.

My C620 SIP Wireless Conference phone does not work at all.

After powering up the base station (see page 3), the LCD display will show



the idle screen. Press  and you will hear a dial tone. If any of this does not happen, please try the following:

- Make sure the DC 5V 800 mA power adapter is securely connected to the base station, and plugged into a wall outlet not controlled by a wall switch.
- Make sure the DC 12V 3A round jack power adapter is securely connected to the conference phone charging dock, and plugged into a wall outlet not controlled by a wall switch.

I cannot dial out.

- Try all the above suggestions.
- Make sure there is a dial tone before dialing.
- If other telephones in your office are having the same problem, the problem is in the wiring or telephone service. Contact your IP PBX system administrator.
- Eliminate any background noise. Dial from another room in your office with less background noise.

The conference phone does not ring when there is an incoming call.

- Make sure there is a dial tone before dialing.
- Make sure the ringer volume of the conference phone is not set to off (page 48).
- Make sure the base station DC 5V 800 mA power adapter, ethernet cable, and the charging dock DC 12V 3A round jack power adapter are plugged in properly (see page 3).
- If other telephones in your office are having the same problem, the problem is in the wiring or IP PBX service. Contact your service provider (charges may apply) or system administrator.
- Other electronic products such as ham radios and other DECT phones can cause interference with your conference phone. Try installing your conference phone as far away as possible from these types of electronic devices.
- Unplug the base station DC 5V 800 mA power adapter from the wall outlet. Wait for approximately 15 seconds, and then plug it back in. If you still cannot get a dial tone, please contact our customer service website designated above for assistance.

Troubleshooting

My wireless mic does not work at all.

The status indicator on the wireless mic turns green within 2 seconds when a call has been established on the conference phone.

If the status indicator remains off and inactive, please follow the steps below:

1. Remove the wireless mic from the charging cradle.
2. Remove the battery from the wireless mic, then install the battery again (page 4).
3. Return the wireless mic to the charging cradle. Make sure the wireless mic is placed in the charging cradle correctly.

The status indicator under the  button should turn orange.

If the status indicator remains off at the time the wireless mic returned to the charging cradle, the wireless mic or the charging cradle is probably defective. Please contact customer service for assistance.

If the status indicator does not turn orange, please follow the steps below:

1. Remove the wireless mic from the charging cradle.
2. Remove the battery from the wireless mic, then install the battery again (page 4).
3. Return the wireless mic to the charging cradle. Make sure the wireless mic is placed in the charging cradle correctly.

The status indicator under the  button should turn orange.
The wireless mic is charging now.

4. Allow the wireless mic to be charged for at least 30 minutes.
5. Remove the wireless mic from the charging cradle again.
6. Establish a call on the phone. The status indicator under the  button should turn green within 2 seconds.

If that still does not work, the wireless mic might have lost its connection to the base station.

1. Deregister all the wireless mics from the base station (see page 53).
2. Register all the wireless mics to the base station (see page 52).
3. Establish a call on the phone. The status indicator under the  button should turn green.

If that still does not work, you might have a defective battery or a defective wireless mic. Please contact customer service for assistance.

Note: Every time the base station is powered up, the wireless mics will need some time to connect to the base station. Please allow at least one minute for the wireless mic and base station to synchronize before use after the base station has powered up.

Note: If you have more than one C620 SIP Wireless Conference phone in the office, use the **Paging** function (page 27) to identify the wireless mics that are

Troubleshooting

connected to the corresponding base station. Make sure that they are not mixed up between each of your C620 SIP Wireless Conference phone.

The callers cannot hear me when I am using the wireless mic.

Try one of the following:

- Make sure the wireless mic is not muted during a call.
- Move the wireless mic closer to the conference phone. It may be out of range.
- Speak into the wireless mic from a distance of no more than 3 feet (91 cm).
- Reset the base station. Unplug the base station DC 5V 800 mA power adapter from the wall outlet. Wait for approximately 15 seconds, and then plug it back in. Allow at least one minute for the wireless mics and base station to synchronize.
- If you have more than one C620 SIP Wireless Conference phone in the office, use the **Paging function (page 27)** to identify the wireless mics that are connected to the corresponding base station. Make sure that they are not mixed up between each of your C620 SIP Wireless Conference phones.
- Other electronic products such as ham radios and other DECT phones can cause interference with your C620 SIP Wireless Conference phone. Try installing your C620 SIP Wireless Conference phone as far away as possible from these types of electronic devices.

Status Indicator on the wireless mic flashes orange.

The wireless mic has low battery.

- Place the wireless mic onto the charging cradle for recharging.

For optimal battery life performances:

- Charge the wireless mics for up to 8 hours before the first time of use.
- Return the wireless mics to the charging cradle after use. Charge them for at least 30 minutes before subsequent uses.

Status Indicator on the wireless mic flashes orange even after a long period of charging.

The efficiency of the battery might have been reduced after being used for some time.

- Make sure the wireless mic is placed in the charging cradle correctly when charging.
- Remove and install the battery again and use it until the battery is fully depleted, and then charge the wireless mic in charging cradle for 8 hours.
- If the above measures do not solve the problem, replace the battery.

Troubleshooting

The status indicator on the wireless mic does not turn orange when in charging cradle.













- The wireless mic might be fully charged.
- Clean the charging contacts on the wireless mic and the charging cradles each month with a pencil eraser or a dry non-abrasive fabric.
- Make sure the base station DC 5V 800 mA power adapter, telephone line, and the charging dock DC 12V 3A round jack power adapter are plugged in properly (see page 3).
- Make sure the wireless mic is placed in the charging cradle correctly.
- Unplug the base station DC 5V 800 mA power adapter . Wait for 15 seconds before plugging it back in. Allow up to one minute for the wireless mic and base station to reset.
- Lift the wireless mic and place it back into the charging cradle. If the wireless mic status indicator turns orange for 5 seconds, and then turns off, the battery is fully charged.

There is interference during a telephone conversation.

My calls fade out when I am using the wireless mic.

- Move the wireless mic closer to the conference phone. It may be out of range.
- Appliances plugged into the same circuit as the base station can cause interference. Try moving the appliance or base station to another outlet.
- Other electronic products such as ham radios and other DECT phones can cause interference with your conference phone. Try installing your conference phone as far away as possible from these types of electronic devices.

I have accidentally set my conference phone language to Spanish or French, and I don't know how to change it back to English.

1. Press  when the conference phone is not in use or on a call.
2. Press  or  to highlight **Estado y configuración** or **Statuts et réglages**, and then press .
3. Press  or  to highlight **Ajustes usuario** or **Régl. utilisat.**, and then press .
4. Press  or  to highlight **Idioma** or **Langage**, and then press .
5. Press  or  to highlight **English**, and then press .

Important safety instructions



This symbol is to alert you to important operating or servicing instructions that may appear on the product or in this user's manual. Always follow basic safety precautions when using this product to reduce the risk of injury, fire, or electric shock.

Important safety instructions

When using your C620 SIP Wireless Conference phone, basic safety precautions should always be followed to reduce the risk of fire, electric shock and injury to persons, including the following:

1. This product should be installed by a qualified technician.
2. This product should only be connected to the host equipment and never directly to the network such as Public Switch Telephone Network (PSTN) or Plain Old Telephone Services (POTS).
3. Read and understand all instructions.
4. Follow all warnings and instructions marked on the product.
5. Unplug this product from the wall outlet before cleaning. Do not use liquid or aerosol cleaners. Use a damp cloth for cleaning.
6. Do not use this product near water such as near a bathtub, wash bowl, kitchen sink, laundry tub or swimming pool, or in a wet basement or shower.
7. Do not place this product on an unstable table, shelf, stand or other unstable surfaces.
8. Slots and openings in the back or bottom of the base unit and wireless mic are provided for ventilation. To protect them from overheating, these openings must not be blocked by placing the product on a soft surface such as a bed, sofa or rug. This product should never be placed near or over a radiator or heat register. This product should not be placed in any area where proper ventilation is not provided.
9. This product should be operated only from the type of power source indicated on the marking label. If you are not sure of the type of power supply in your office, consult your dealer or local power company.
10. Do not allow anything to rest on the power cord. Do not install this product where the cord may be walked on.
11. Never push objects of any kind into this product through the slots in the base unit or wireless mic because they may touch dangerous voltage points or create a short circuit. Never spill liquid of any kind on the product.
12. To reduce the risk of electric shock, do not disassemble this product, but take it to an authorized service facility. Opening or removing parts of the base unit or wireless mic other than specified access doors may expose you to dangerous voltages or other risks. Incorrect reassembling can cause electric shock when the product is subsequently used.
13. Do not overload wall outlets and extension cords.

Important safety instructions

14. Unplug this product from the wall outlet and refer servicing to an authorized service facility under the following conditions:
 - A. When the power supply cord or plug is damaged or frayed.
 - B. If liquid has been spilled onto the product.
 - C. If the product has been exposed to rain or water.
 - D. If the product does not operate normally by following the operating instructions. Adjust only those controls that are covered by the operation instructions. Improper adjustment of other controls may result in damage and often requires extensive work by an authorized technician to restore the product to normal operation.
 - E. If the product has been dropped and the base unit and/or wireless mic has been damaged.
 - F. If the product exhibits a distinct change in performance.
15. Avoid using the C620 SIP Wireless Conference phone during an electrical storm. There is a remote risk of electric shock from lightning.
16. Do not use the C620 SIP Wireless Conference phone to report a gas leak in the vicinity of the leak. Under certain circumstances, a spark may be created when the adapter is plugged into the power outlet, or when the wireless mic is replaced in its cradle. This is a common event associated with the closing of any electrical circuit. The user should not plug the phone into a power outlet, and should not put a charged wireless mic onto the charging cradle, if the phone is located in an environment containing concentrations of flammable or flame-supporting gases, unless there is adequate ventilation. A spark in such an environment could create a fire or explosion. Such environments might include: medical use of oxygen without adequate ventilation; industrial gases (cleaning solvents; gasoline vapors; etc.); a leak of natural gas; etc.
17. Only put the wireless mic next to your mouth when it is in normal talk mode.
18. The power cables are intended to be correctly oriented in a vertical or floor mount position. The prongs are not designed to hold the plug in place if it is plugged into a ceiling or cabinet outlet.
19. Use only the adapter included with this product. Incorrect adapter polarity or voltage can seriously damage the product.
20. For pluggable equipment, the socket-outlet shall be installed near the equipment and shall be easily accessible.
21. In wall mounting position, make sure to mount the telephone base on the wall by aligning the eyelets with the mounting studs of the wall plate. Then slide the telephone base down on both mounting studs until it locks into place. Refer to the full installation instructions in the User Manual.
22. CAUTION: Keep small metallic objects such as pins and staples away from the handset receiver.

Important safety instructions

23. **CAUTION:** Use only the batteries indicated in this manual. There may be a risk of explosion if a wrong type of battery is used. Use only the supplied rechargeable battery or replacement battery pack. Do not dispose of batteries in a fire. They may explode. Dispose of used battery according to the information in The RBRC® seal.
24. **WARNING:** The product included (ITE) in this manual is to be connected only to PoE networks without routing to the outside plant.

SAVE THESE INSTRUCTIONS

Important safety instructions

Battery

- **CAUTION:** Use Only Supplied Battery.
- Do not dispose of the battery in a fire. Check with local waste management codes for special disposal instructions.
- Do not open or mutilate the battery. Released electrolyte is corrosive and may cause burns or injury to the eyes or skin. The electrolyte may be toxic if swallowed.
- Exercise care in handling batteries in order not to create a short circuit with conductive materials.
- Charge the battery provided with or identified for use with this product only in accordance with the instructions and limitations specified in this manual.

About wireless mics

- **Privacy:** The same features that make a wireless mic convenient create some limitations. Calls on conference phones are transmitted between the base unit and the wireless mic by radio waves, so there is a possibility that the wireless mic conversations could be intercepted by radio receiving equipment within range of the wireless mic. For this reason, you should not think of conference phone conversations as being as private as those on corded telephones.
- **Electrical power:** The base unit of this conference phone must be connected to a working electrical outlet. The electrical outlet should not be controlled by a wall switch. Calls cannot be made from the conference phone if the base unit is unplugged, switched off or if the electrical power is interrupted.
- **Potential TV interference:** Wireless mic operates at frequencies that may cause interference to televisions and VCRs. To minimize or prevent such interference, do not place the base unit near or on top of a TV or VCR. If interference is experienced, moving the wireless mic farther away from the TV or VCR often reduces or eliminates the interference.
- **Rechargeable batteries:** Exercise care in handling batteries in order not to create a short circuit with conducting material such as rings, bracelets and keys. The battery or conductor may overheat and cause harm.
- **Nickel-metal hydride rechargeable batteries:** Dispose of these batteries in a safe manner. Do not burn or puncture. Like other batteries of this type, if burned or punctured, they could release caustic material which could cause injury.

Maintenance

Taking care of your C620 SIP Wireless Conference phone

Your conference phone contains sophisticated electronic parts, so it must be treated with care.

Avoid rough treatment

Place the wireless mic down gently. Save the original packing materials to protect your C620 SIP Wireless Conference phone if you ever need to ship it.

Avoid water

Your C620 SIP Wireless Conference phone can be damaged if it gets wet. Do not use the wireless mic outdoors in the rain, or handle it with wet hands. Do not install the base unit near a sink, bathtub or shower.

Electrical storms

Electrical storms can sometimes cause power surges harmful to electronic equipment. For your own safety, take caution when using electrical appliances during storms.

Cleaning your C620 SIP Wireless Conference phone

Your C620 SIP Wireless Conference phone has a durable plastic casing that should retain its luster for many years. Clean it only with a soft cloth slightly dampened with water or mild soap. Do not use excess water or cleaning solvents of any kind.

Remember that electrical appliances can cause serious injury if used when you are wet or standing in water. If the base unit should fall into water, **DO NOT RETRIEVE IT UNTIL YOU UNPLUG THE AC POWER CORD FROM THE WALL.** Then, remove the telephone by the unplugged cords.

FCC and IC regulations

FCC part 15

This device complies with Part 15 of the FCC rules. Operation is subject to the following two conditions: (1) This device may not cause harmful interference, and (2) this device must accept any interference received, including interference that may cause undesired operation.

This equipment has been tested and found to comply with the limits for a Class B digital device, pursuant to Part 15 of the FCC rules. These limits are designed to provide reasonable protection against harmful interference in residential installation.

This equipment generates, uses and can radiate radio frequency energy and, if not installed and used in accordance with the instructions, may cause harmful interference to radio communications. However, there is no guarantee that interference will not occur in a particular installation; if this equipment does cause harmful interference to radio or television reception, which can be determined by turning the equipment off and on, you are encouraged to try to correct the interference by one of the following measures:

- Reorient or relocate the receiving television or radio antenna.
- Increase the separation between the telephone equipment and the receiver.
- Connect the telephone equipment into an outlet on a circuit different from that to which the television, radio or other receiver is connected.
- Consult the dealer or an experienced Radio/TV Technician for help.

Privacy of communications may not be ensured when using this phone.

Warning: Changes or modifications to this equipment not expressly approved by the party responsible for compliance could void the user's authority to operate the equipment.

Caution: To maintain the compliance with the FCC's RF exposure guideline, place the base unit at least 20 cm from nearby persons.

The C620 base station has been tested and meets the FCC RF exposure guidelines when used with the accessories supplied or designated for this product. Use of other accessories may not ensure compliance with FCC RF exposure guidelines.

FCC and IC regulations

Industry Canada

This Class B digital apparatus complies with Canadian requirements: CAN ICES-3 (B)/NMB-3(B). Cet appareil numérique de la classe B est conforme à la norme CAN ICES-3 (B)/NMB-3(B) du Canada.

This device contains licence-exempt transmitter(s)/receiver(s) that comply with Innovation, Science and Economic Development Canada's licence-exempt RSS(s).

Operation is subject to the following two conditions: (1) this device may not cause interference, and (2) this device must accept any interference, including interference that may cause undesired operation of the device.

Privacy of communications may not be ensured when using this telephone.

The term "IC:" before the certification/registration number only signifies that the Industry Canada technical specifications were met.

This product meets the applicable Innovation, Science and Economic Development Canada technical specifications.

The RBRC® seal



The RBRC® Seal means that the manufacturer is voluntarily participating in an industry program to collect and recycle nickel-metal hydride rechargeable batteries when taken out of service within the United States. These batteries may be taken to a participating local retailer of replacement batteries or recycling center. Or you may call 1 (800) 8 BATTERY® for locations accepting spent Ni-MH batteries.

RBRC® and 1 (800) 8 BATTERY® are registered trademarks of the Rechargeable Battery Recycling Corporation.

California Energy Commission (CEC) battery charging testing instructions

This telephone is set up to comply with the energy-conserving standards right out of the box. These instructions are intended for CEC compliance testing only. When the CEC battery charging testing mode is activated, all telephone functions, except battery charging, will be disabled.

These instructions assume that all devices have been registered to the base unit before activating this test mode.

To activate the CEC battery charging testing mode:

1. Remove the conference phone from the charging dock.
2. Remove the battery from the conference phone.
3. Press and hold **MUTE ALL** on the conference phone.
4. With the **MUTE ALL** key pressed, insert the battery in the conference phone, and then wait for 5 seconds.
5. When the conference phone status indicators start flashing red, release **MUTE ALL**, and then press **MUTE ALL** immediately.

The conference phone displays the message:
"To use the phone again, please reset the power."

6. Put the conference phone on the charging dock to charge the conference phone battery.

The battery icon  indicates the charge status as the battery charges.

To deactivate the CEC battery charging testing mode:

1. Remove the conference phone from the charging dock.
2. Remove the battery from the conference phone.
3. Reinsert the battery in the conference phone without pressing any keys.

For cUL compliance only

Mesures de sécurité importantes



Ce symbole vous alertera d'informations importantes ou d'instructions d'entretien pouvant apparaître dans ce guide d'utilisation. Respectez toujours les mesures de sécurité et de sécurité de base lorsque vous utilisez ce produit, afin de réduire les risques de blessures, d'incendie, ou d'électrocution.

Mesures de sécurité importantes

Vous devez toujours observer des mesures de précaution lorsque vous utilisez le Téléphone de conférence à protocole d'initialisation de session SIP C620, afin d'éviter les risques d'incendie, d'électrocution et de blessures, incluant ce qui suit :

1. Cet appareil doit être installé par un technicien qualifié.
2. Cet appareil doit être branché à un équipement hôte et jamais branché à un réseau, tel qu'un réseau PSTN publique ou un réseau téléphonique standard (POTS).
3. Lisez et comprenez bien toutes les instructions.
4. Observez toutes les instructions et mises en garde inscrites sur l'appareil.
5. Débranchez ce téléphone de la prise murale avant de le nettoyer. N'utilisez pas de nettoyeurs liquides ni en aérosol. N'utilisez qu'un chiffon doux et légèrement humecté.
6. N'utilisez pas ce produit près de l'eau, tel que près d'un bain, d'un lavabo, d'un évier de cuisine, d'un bac de lavage ou d'une piscine, ou dans un sous-sol humide ou sous la douche.
7. Ne déposez pas ce téléphone sur un chariot, support ou table chancelants. L'appareil pourrait tomber et être sérieusement endommagé.
8. Les ouvertures situées à l'arrière ou sous le socle et le microphone sans fil servent à la ventilation. Afin d'empêcher la surchauffe, ces ouvertures ne doivent pas être obstruées en plaçant l'appareil sur un lit, divan, tapis ou autre surface similaires. Ne placez pas cet appareil à proximité d'un élément de chauffage ni d'une plinthe électrique. De plus, ne l'installez pas dans une unité murale ou un cabinet fermé qui ne possède pas d'aération adéquate.
9. Ne faites fonctionner cet appareil qu'avec le type d'alimentation indiqué sur les étiquettes de l'appareil. Si vous ne connaissez pas le voltage de votre maison, consultez votre marchand ou votre fournisseur d'électricité.
10. Ne déposez rien sur le cordon d'alimentation. Installez cet appareil dans un endroit sécuritaire, là où personne ne pourra trébucher sur la ligne d'alimentation ni le cordon téléphonique modulaire.
11. N'enfoncez jamais d'objets dans les fentes du socle ou du microphone sans fil, car ceci risquerait d'entrer en contact avec des points de tension dangereux ou provoquer un court-circuit. N'échappez pas de liquides dans l'appareil.

Mesures de sécurité importantes

12. Afin de réduire les risques d'électrocution, ne démontez pas l'appareil, mais apportez-le plutôt à un centre de service qualifié s'il doit être réparé. L'ouverture ou le retrait de pièces du socle ou du microphone sans fil autre que les portes d'accès peuvent vous exposer à des tensions dangereuses et à d'autres risques. Débranchez l'appareil avant de procéder au nettoyage. Utilisez un chiffon humide et doux.
13. Ne surchargez pas les prises de courant et les rallonges.
14. Débranchez cet appareil de la prise de courant et communiquez avec le département de service à la clientèle de Snom dans les cas suivants :
 - A. Lorsque le cordon d'alimentation est endommagé ou écorché.
 - B. Si du liquide a été échappé dans l'appareil.
 - C. Si l'appareil a été exposé à une source d'humidité telle que la pluie ou l'eau.
 - D. Si le produit ne fonctionne pas normalement en respectant les instructions de fonctionnement. Réglez uniquement les commandes indiquées dans les instructions de fonctionnement. Les réglages incorrects des autres commandes pourraient provoquer un dommage qui pourrait exiger un travail exhaustif de la part d'un technicien autorisé afin de rétablir le fonctionnement normal de l'appareil.
 - E. Si le produit a été échappé et que le socle et/ou le microphone sans fil a été endommagé.
 - F. Si le produit affiche une nette diminution de sa performance.
15. Évitez d'utiliser le Téléphone de conférence à protocole d'initialisation de session SIP C620 pendant un orage.
16. N'utilisez pas le Téléphone de conférence à protocole d'initialisation de session SIP C620 pour rapporter une fuite de gaz à proximité de la fuite. En certaines circonstances, une flammèche pourrait être provoquée lorsque l'adaptateur est branché dans une prise de courant ou lorsque le microphone auxiliaire est déposé sur son socle. Ceci est un événement commun associé à la fermeture d'un circuit électrique. L'utilisateur ne doit pas brancher le téléphone dans une prise de courant ni insérer un microphone sans fil rechargé dans le socle, si le téléphone se trouve dans un environnement contenant des concentrations de matières inflammables ou autres gaz susceptibles de produire des flammes, sauf en présence d'une aération adéquate. Une flammèche dans un tel endroit pourrait provoquer un incendie ou une explosion. De tels environnements peuvent comprendre: des endroits où l'on utilise de l'oxygène médical sans ventilation adéquate; des gaz industriels (dissolvants de nettoyage, des vapeurs d'essence, etc.); une fuite de gaz naturel, etc.
17. Ne déposez que le microphone sans fil près de votre oreille que lorsqu'il est en mode de conversation normale.
18. Ces adaptateurs ont été conçus pour être orientés en position verticale ou montés au sol. Les broches ne sont pas conçues pour maintenir l'adaptateur

Mesures de sécurité importantes

en place si celui-ci est branché dans une prise au plafond ou sous une table/ armoire.

19. N'utilisez que les adaptateurs inclus avec ce produit. L'utilisation d'un adaptateur dont la polarité ou la tension serait inadéquate risque d'endommager sérieusement le produit et mettre votre sécurité en péril.
20. Pour les PRODUITS À BRANCHER À UNE PRISE DE COURANT, la prise de courant doit être installée près du produit, afin d'assurer une accessibilité sécuritaire à la prise de courant.
21. En position de montage mural, assurez-vous de monter le socle du téléphone sur le mur en alignant les œillets avec les goujons de fixation de la plaque murale. Ensuite, faites glisser le socle vers le bas sur les deux goujons de fixation jusqu'à ce qu'il se verrouille en place. Reportez-vous aux instructions complètes dans la section Installation dans ce guide d'utilisation.
22. MISE EN GARDE : Éloignez les petits objets métalliques tels que les broches de l'écouteur du combiné.
23. MISE EN GARDE : Il peut y avoir un risque d'explosion si vous utilisez le mauvais type de piles. N'utilisez que le bloc-piles rechargeable inclus ou le bloc-piles de rechange. N'incinerez pas les piles. Celles-ci risqueraient d'exploser. Jetez les piles usées selon les renseignements suivant le sceau du RBRC^{MD}.
24. AVERTISSEMENT : Le produit inclus (ITE) dans ce guide doit être connecté uniquement aux réseaux PoE sans être acheminé vers l'installation extérieure.

CONSERVEZ CES INSTRUCTIONS

Mesures de sécurité importantes

Pile

- MISE EN GARDE : N'utilisez que la pile incluse.
- Ne jetez pas la pile au feu. Vérifiez les instructions spécifiques de mise aux rebus auprès des autorités locales.
- N'ouvrez pas et ne mutilez pas la pile. L'électrolyte qui s'en échapperait est corrosif et pourrait causer des brûlures ou des blessures aux yeux ou à la peau. L'électrolyte est toxique si avalé.
- Soyez prudents lorsque vous manipulez les piles afin d'éviter les courts-circuits provoqués par des matériaux conducteurs.
- Rechargez la pile incluse avec cet appareil, selon les instructions et limites spécifiées dans ce guide d'utilisation.

À propos des microphones sans fil

- **Confidentialité:** Les mêmes caractéristiques qui constituent des avantages pour les téléphones sans fil affichent également des restrictions. Les appels téléphoniques sur les téléphones conférence sans fil sont transmis entre le combiné sans fil et le socle par le biais d'ondes radio ; il y a donc la possibilité que vos conversations téléphoniques sans fil soient interceptées par des équipements de réception radio se trouvant dans la portée du combiné sans fil. Pour cette raison, vous ne devez pas percevoir les communications sur les téléphones conférence sans fil comme étant aussi confidentielles que celles des téléphones à cordons.
- **Alimentation électrique:** Le socle de ce téléphone conférence sans fil doit être branché à une prise électrique fonctionnelle. La prise électrique ne doit pas être contrôlée par un interrupteur mural. Les appels ne pourront pas être effectués du téléphone conférence sans fil si le socle est débranché ou mis hors tension ou si le courant est interrompu.
- **Possibilité d'interférences aux téléviseurs:** Certains microphones sans fil sans fil fonctionnent sur des fréquences pouvant causer des interférences aux téléviseurs et aux magnétoscopes. Pour réduire ou prévenir de telles interférences, ne placez pas le socle du téléphone sans fil à proximité ou sur un téléviseur ou magnétoscope. S'il y a présence de parasites, il est conseillé d'éloigner le téléphone sans fil du téléviseur ou du magnétoscope afin de réduire possiblement les interférences.
- **Piles rechargeables:** Manipulez les piles avec soin afin de ne pas les court-circuiter avec des bagues, bracelets ou clés. Les piles ou le conducteur peut surchauffer et causer des blessures.
- **Les bloc-piles rechargeables à l'hydrure métallique de nickel:** Jetez ces blocs-piles de manière écologique et sécuritaire. Ne les incinerez pas et ne les percez pas. Tel que les autres piles de ce type, elles pourraient dégager une matière toxique qui peut causer des blessures corporelles si elles sont brûlées ou percées.

Technical specifications

Connector	1 x RJ45 (Ethernet) - LAN	
Ethernet	10/100 MB	
Power requirements	Base Unit	Power over Ethernet (PoE): IEEE 802.3af, Class 2
		If PoE not available: Power adapter (included in delivery): Model number: NBS12E050200UV Input: 100-240V AC 50/60Hz 0.3A Output: 5V DC 2.0A -OR- Model number: S006AKU0500080 Input: 100-240V AC 50/60Hz Output: 5.0V DC 800mA
	Conference Phone	Battery: (BT200660) 7.2V 4000mAh Ni-MH
		Charging dock power adapter: Model number: S042-1A120300VU Input: 100-240V AC 50/60Hz 1.0A Output: 12V DC 3.0A -OR- Model number: CS36M120300FUF Input: 100-240V AC 50/60Hz Output: 12V DC 3.0A
	Wireless Mics	Battery: (BT183642/BT283642) 2.4V, 400mAh Ni-MH
Optimal distance between conference phone or wireless mic and participant: 60 cm (24 inches)		
Minimum distance between microphones: 30 cm (12 inches)		

VTECH COMMUNICATIONS, INC.

Tigard, Oregon 97223, USA.

Specifications are subject to change without notice.

Copyright © 2024 Snom Technology GmbH. All Rights Reserved.

v2024006 Version 12/2024